

Public Input No. 196 assigned to Code-Making  
Panel 4, Refer to Code-Making Panel 15



## Public Input No. 196-NFPA 70-2023 [ Definitions (100): Microgrid.... to Microgrid

### Definitions (100): Microgrid.... to Microgrid I...

#### **Microgrid Hybrid Power System .**

An electric power system capable of operating in island mode and capable of being interconnected to an electric power production and distribution network or other primary source while operating in interactive mode, which includes the ability to disconnect from and reconnect to a primary source and operate in island mode. (CMP-4)

Informational Note No. 1: See IEEE 1547, *IEEE Standard for Interconnection and Interoperability of Distributed Energy Resources with Associated Electric Power Systems Interface*; IEEE 2030.7, *IEEE Standard for the Specification of Microgrid Controllers*; IEEE 2030.8, *IEEE Standard for the Testing of Microgrid Controllers*; and UL1008B, *Outline for Source Interconnection*, for additional information about microgrids.

Informational Note No. 2: Examples of power sources in microgrids include such items as photovoltaic systems, generators, fuel cell systems, wind electric systems, energy storage systems, electric vehicles that are used as a source of supply, and electrical power conversion from other energy sources.

#### **~~Microgrid, Health Care (Health Care Microgrid System).~~ (Health Care Microgrid) Hybrid Power System**

A group of interconnected loads and distributed energy resources within clearly defined boundaries that acts as a single controllable entity with respect to the utility. [99:3.3.75] (517) (CMP-15)

#### **~~Microgrid- Hybrid Power Control System (MCS).~~**

A structured control system that manages microgrid operations, functionalities for utility interoperability, islanded operations, and transitions. (CMP-4)

Informational Note: MCS differ from multiple standby generators or uninterruptible power supplies that are evaluated and rated to operate as a single source of backup power upon loss of the primary power source. MCS functions include coordination, transitions, and interoperability between multiple power sources.

#### **~~Microgrid- Hybrid Power System Interconnect Device (MID HPID) .~~**

A device that enables a microgrid system to separate from and reconnect to an interconnected primary power source. (CMP-4)

## Statement of Problem and Substantiation for Public Input

There's multiple definitions for "microgrid." However, as an extension of the term "grid" it best is thought of as a system with diversity, such as multiple power sources, multiple voltages, and multiple buildings. Why support such a dubious definition, which considers anyone who has standalone capability for their small rooftop solar installation as the owner of a microgrid? The Department Of Energy defines a microgrid as "a group of interconnected loads and distributed energy resources within clearly defined electrical boundaries that acts as a single controllable entity with respect to the grid. A microgrid can connect and disconnect from the grid to enable it to operate in both grid-connected or island-mode." This does not sound like the individual who just installed solar panels with a battery backup and islanding capability, on their house.

See Wikipedia definition of the term "Grid" which doesn't in any sense bring to mind the people who have islanding capable solar on their house:  
[https://en.wikipedia.org/wiki/Electrical\\_grid](https://en.wikipedia.org/wiki/Electrical_grid)

See references to DOE microgrid definition:

<https://emilms.fema.gov/IS0815/groups/32.html>

<https://www.naseo.org/issues/electricity/microgrids>

[https://www.researchgate.net/figure/Microgrid-Concept-A-microgrid-is-a-group-of-interconnected-loads-and-distributed-energy\\_fig1\\_332984667](https://www.researchgate.net/figure/Microgrid-Concept-A-microgrid-is-a-group-of-interconnected-loads-and-distributed-energy_fig1_332984667)

<https://sustainablesolutions.duke-energy.com/resources/three-types-of-microgrids/>

## Submitter Information Verification

**Submitter Full Name:** Josh Weaver

**Organization:** [ Not Specified ]

**Street Address:**

**City:**

**State:**

**Zip:**

**Submittal Date:** Thu Jan 19 20:52:02 EST 2023

**Committee:** NEC-P04

### Copyright Assignment

I, Josh Weaver, hereby irrevocably grant and assign to the National Fire Protection Association (NFPA) all and full rights in copyright in this Public Input (including both the Proposed Change and the Statement of Problem and Substantiation). I understand and intend that I acquire no rights, including rights as a joint author, in any publication of the NFPA in which this Public Input in this or another similar or derivative form is used. I hereby warrant that I am the author of this Public Input and that I have full power and authority to enter into this copyright assignment.

By checking this box I affirm that I am Josh Weaver, and I agree to be legally bound by the above Copyright Assignment and the terms and conditions contained therein. I understand and intend that, by checking this box, I am creating an electronic signature that will, upon my submission of this form, have the same legal force and effect as a handwritten signature

**Public Input No. 3085, Assigned to Code-Making  
Panel 1, Refer to Code-Making Panels 2 - 18**



**Public Input No. 3085-NFPA 70-2023 [ Global Input ]**

**This Global Public Input is for all Technical Committees and review their informational notes and the requirements in the NEC Style Manual Section 2.1.10 for informational notes.**

## Statement of Problem and Substantiation for Public Input

This Global Public Input is for all Technical Committees and review their informational notes and the requirements in the NEC Style Manual Section 2.1.10 for informational notes.  
2.1.10.3 Format. Informational notes shall be structured as shown in the example, using the word "See" followed by the reference standard, the title of the standard and section if used, and an explanation for the reference.

Example:

"See" "Referenced Standard", "Standard Title", "Section Number", "Explanation of the reference"

Informational Note: See NFPA 101, Life Safety Code, 7.8, for illumination of means of egress.

The Usability Task Group members are: Derrick Atkins, David Hittinger, Richard Holub, Dean Hunter, Chad Kennedy and David Williams.

## Submitter Information Verification

**Submitter Full Name:** David Williams

**Organization:** Delta Charter Township

**Street Address:**

**City:**

**State:**

**Zip:**

**Submittal Date:** Tue Aug 29 11:15:17 EDT 2023

**Committee:** NEC-P01

### Copyright Assignment

I, David Williams, hereby irrevocably grant and assign to the National Fire Protection Association (NFPA) all and full rights in copyright in this Public Input (including both the Proposed Change and the Statement of Problem and Substantiation). I understand and intend that I acquire no rights, including rights as a joint author, in any publication of the NFPA in which this Public Input in this or another similar or derivative form is used. I hereby warrant that I am the author of this Public Input and that I have full power and authority to enter into this copyright assignment.

By checking this box I affirm that I am David Williams, and I agree to be legally bound by the above Copyright Assignment and the terms and conditions contained therein. I understand and intend that, by checking this box, I am creating an electronic signature that will, upon my submission of this form, have the same legal force and effect as a handwritten signature

**Public Input No. 3086, Assigned to Code-Making  
Panel 2, Refer to Code Making Panels 3 - 18**



**Public Input No. 3086-NFPA 70-2023 [ Global Input ]**

**This Global Public Input is being submitted on behalf of the NEC Correlating Committee Usability Task Group in order to provide correlation throughout the document. Articles may need to be revised to comply with the NEC Style Manual Section 2.2 for Numbering Conventions.**

### Statement of Problem and Substantiation for Public Input

This Global Public Input is being submitted on behalf of the NEC Correlating Committee Usability Task Group in order to provide correlation throughout the document.

Articles may need to be revised to comply with the NEC Style Manual Section 2.2 for Numbering Conventions. The Changes in 2.2.1 are requirements that may need to be revised.

2.2.1 Parallel Numbering Required. Technical committees shall use the following section numbers for the same purposes within articles. This requirement shall not apply to Articles 90, 100, and 110. If the article does not contain listing or reconditioning requirements, the subdivisions shall not be included in the article.

Required Parallel Numbering Format

XXX.1 Scope.

XXX.2 Listing Requirements.

XXX.3 Reconditioned Equipment.

XXX.3(A) Permitted to be Installed.

XXX.3(B) Not Permitted to be Installed.

The Usability Task Group members are: Derrick Atkins, David Hittinger, Richard Holub, Dean Hunter, Chad Kennedy and David Williams.

### Submitter Information Verification

**Submitter Full Name:** David Williams

**Organization:** Delta Charter Township

**Street Address:**

**City:**

**State:**

**Zip:**

**Submission Date:** Tue Aug 29 11:17:37 EDT 2023

**Committee:** NEC-P02

#### Copyright Assignment

I, David Williams, hereby irrevocably grant and assign to the National Fire Protection Association (NFPA) all and full rights in copyright in this Public Input (including both the Proposed Change and the Statement of Problem and Substantiation). I understand and intend that I acquire no rights, including rights as a joint author, in any publication of the NFPA in which this Public Input in this or another similar or derivative form is used. I hereby warrant that I am the author of this Public Input and that I have full power and authority to enter into this copyright assignment.

By checking this box I affirm that I am David Williams, and I agree to be legally bound by the above Copyright Assignment and the terms and conditions contained therein. I understand and intend that, by checking this box, I am creating an electronic signature that will, upon my submission of this form, have the same legal force and effect as a handwritten signature

**Public Input No. 4050, Assigned to Code-Making Panel  
10, Refer to Code-Making Panels 1 - 9 and 11 - 18**



**Public Input No. 4050-NFPA 70-2023 [ Global Input ]**

**Review the terms regarding overcurrent protection and determine if the correct term is being used.**

- (1) Branch-Circuit Overcurrent Protective Device**
- (2) Current-Limiting Overcurrent Protective Device**
- (3) Current-Limiting**
- (4) Current-Limiting Overcurrent**
- (5) Overcurrent Protection**
- (6) Overcurrent Protection Device**
- (7) Overcurrent Protective Device**
- (8) Supplementary Overcurrent Protective Device**
- (9) Supplementary Overcurrent Protection**

## Statement of Problem and Substantiation for Public Input

The defined terms regarding overcurrent protection need to be reviewed by all code making panels and determine if the correct term is being used. The code has too many terms regarding overcurrent protection, some that are defined and some that are not defined. These terms are often used interchangeably in the wrong context.

## Submitter Information Verification

**Submitter Full Name:** David Williams  
**Organization:** Delta Charter Township  
**Street Address:**  
**City:**  
**State:**  
**Zip:**  
**Submission Date:** Wed Sep 06 14:59:12 EDT 2023  
**Committee:** NEC-P10

### Copyright Assignment

I, David Williams, hereby irrevocably grant and assign to the National Fire Protection Association (NFPA) all and full rights in copyright in this Public Input (including both the Proposed Change and the Statement of Problem and Substantiation). I understand and intend that I acquire no rights, including rights as a joint author, in any publication of the NFPA in which this Public Input in this or another similar or derivative form is used. I hereby warrant that I am the author of this Public Input and that I have full power and authority to enter into this copyright assignment.

By checking this box I affirm that I am David Williams, and I agree to be legally bound by the above Copyright Assignment and the terms and conditions contained therein. I understand and intend that, by checking this box, I am creating an electronic signature that will, upon my submission of this form, have the same legal force and effect as a handwritten signature

**Public Input No. 4287, Assigned to Code-Making  
Panel 1, Refer to Code-Making Panels 2 - 18**



**Public Input No. 4287-NFPA 70-2023 [ Global Input ]**

Clearly identify any requirements which are not applicable to DC circuits by incorporating the recommended terminology as applicable:

“Applicable to...[ac][single-phase][three-phase][wye][delta] circuits only”.

“Not applicable to dc circuits”

“[Volts] ac only”

Other terminology that clearly applies to a specific ac (or dc) application, such as through a defined term or unique equipment.

## Statement of Problem and Substantiation for Public Input

This Public Input is submitted on behalf of a Correlating Committee DC Task Group consisting of Danish Zia, Jason Fisher, Randy Dollar, Larry Wildermuth, Scott Higgins, Scott Harding, Mark Earley, Jason Hopkins, Christopher Vance, Chad Kennedy and Derrick Atkins. This Public Input, along with other Public Inputs, was developed with the goal of improving usability and accuracy on requirements associated with DC circuits.

DC residential and commercial installations are emerging in the electrical infrastructure and are expected to be a growing alternative to the traditional AC utility fed building. Examples include the US DOE Grid-interactive Efficient Buildings project (Note 1), the Purdue University RENEWW house (Note 2), and a DC Microgrid community in Vermont (Note 3). These installations may involve buildings that are distributed entirely with DC, or with an AC/DC hybrid distribution.

Although DC electrical distribution topics are covered by the NEC, the focus of most residential and commercial installations and the Code has historically been AC power. Many requirements are written using AC terminology or referencing only AC technology, but without distinction as to whether the requirement is also applicable to DC circuits or installations. Usage of terms such as “2-wire” and “3-wire”, or listing AC only voltages as informative references without appropriate mandatory language or further clarification may not provide sufficient clarity as to whether a requirement applies to DC circuits. This may leave the AHJ and other users of the Code confused. This public input recommends that such requirements be reviewed and clarified using the recommended terminology proposed.

Note 1 - <https://www.energy.gov/sites/default/files/2020/09/f79/bto-geb-project-summary-093020.pdf>

Note 2 - <https://engineering.purdue.edu/ME/News/2022/purdue-house-runs-entirely-on-dc-power>

Note 3 - [https://www.encyvermont.com/Media/Default/docs/white-papers/Energy\\_Resilience.pdf](https://www.encyvermont.com/Media/Default/docs/white-papers/Energy_Resilience.pdf)

## Submitter Information Verification

**Submitter Full Name:** Danish Zia

**Organization:** UL Solutions

**Street Address:**

**City:**

**State:**

**Zip:**

**Submission Date:** Thu Sep 07 09:28:38 EDT 2023

**Committee:** NEC-P01

**Copyright Assignment**

I, Danish Zia, hereby irrevocably grant and assign to the National Fire Protection Association (NFPA) all and full rights in copyright in this Public Input (including both the Proposed Change and the Statement of Problem and Substantiation). I understand and intend that I acquire no rights, including rights as a joint author, in any publication of the NFPA in which this Public Input in this or another similar or derivative form is used. I hereby warrant that I am the author of this Public Input and that I have full power and authority to enter into this copyright assignment.

By checking this box I affirm that I am Danish Zia, and I agree to be legally bound by the above Copyright Assignment and the terms and conditions contained therein. I understand and intend that, by checking this box, I am creating an electronic signature that will, upon my submission of this form, have the same legal force and effect as a handwritten signature



## Public Input No. 2428-NFPA 70-2023 [ Global Input ]

See Attached File - Which Includes multiple related changes, all under the purview of CMP 15.

### Additional Proposed Changes

<u>File Name</u>	<u>Description</u>	<u>Approved</u>
PI_For_CMP_15_Voltage_Demarcation_.docx	Global PI for CMP 15 (Consistent Voltage Demarcation)	

### Statement of Problem and Substantiation for Public Input

This Public Input is submitted on behalf of a Correlating Committee Task Group consisting of Robert Osborne (Chair), Paul Barnhart, Lou Grahor, Donny Cook, Scott Higgins, Mike Querry, Roger McDaniel, Dave Burns, Rod Belisle, Kevin Rogers, Tony Ricciuti, Paul Knapp, Paul Sullivan, George Smith, Eric Simmon, Kevin Arnold, Larry Wildermuth, and Kyle Krueger.

Changes related to the voltage demarcation have been grouped to assist the CMP with review and resolution, with each change, and it's corresponding substantiation, noted in the table below: (table provided in attachment)

### Submitter Information Verification

**Submitter Full Name:** Robert Osborne  
**Organization:** UL Solutions  
**Street Address:**  
**City:**  
**State:**  
**Zip:**  
**Submittal Date:** Thu Aug 17 09:41:57 EDT 2023  
**Committee:** NEC-P15



This Public Input is submitted on behalf of a Correlating Committee Task Group consisting of Robert Osborne (Chair), Paul Barnhart, Lou Grahor, Donny Cook, Scott Higgins, Mike Querry, Roger McDaniel, Dave Burns, Rod Belisle, Kevin Rogers, Tony Ricciuti, Paul Knapp, Paul Sullivan, George Smith, Eric Simmon, Kevin Arnold, Larry Wildermuth, and Kyle Krueger.

Changes related to the voltage demarcation have been grouped to assist the CMP with review and resolution, with each change, and it's corresponding substantiation, noted in the table below:

Reference	Suggested Revision	Substantiation
517.30(B)(3)	<p><b>Fuel Cell Systems.</b>            Fuel cell systems shall be permitted to serve as the alternate power source for all or part of an EES. [99:6.7.1.5.1]  <del>(a) Installation of fuel cells shall comply with the requirements in Parts I through VII of Article 692 for 1000 volts or less and Part VIII for over 1000 volts.</del></p>	<p>Part VIII of Article 692 (which is the reference being proposed for deletion) was deleted from the NEC in 2017. Fuel Cells must comply with Article 692, and the reference to this Article is unnecessary.</p>
517.71(C)	<p><b>Over 1000- Volt ac, 1500 Volts dc, Supply.</b> Circuits and equipment operated on a supply circuit of over 1000 volts <u>ac</u>, 1500 volts <u>dc</u> shall comply with Parts I through IV or Article 495.</p>	<p>Requirements are revised to include the same voltage demarcation used in many places throughout the Code.</p>
530.71	<p><b>General.</b>            Wiring and equipment in portable substations rated 50 <u>ac/dc</u> to 1000 volts <u>ac</u>, 1500 <u>volts dc</u>, nominal, shall conform to ...</p>	<p>Requirements are revised to include the same voltage demarcation used in many places throughout the Code.</p>
530.72	<p><b>Over 1000 Volts ac, 1500 Volts dc, Nominal.</b>            Wiring and equipment of portable substations rated over 1000 volts <u>ac</u>, 1500 <u>volts dc</u>, nominal, shall comply with the requirements of Part IV of Article 490/495</p>	<p>Requirements are revised to include the same voltage demarcation used in many places throughout the Code.</p>



## Public Input No. 3099-NFPA 70-2023 [ Global Input ]

**Add Informational Notes to Scopes identifying Article specific and/or important definitions in one of the following formats:**

**Format A – the style used in NFPA Link’s Enhanced Content material:**

**Informational Note No. x: Definitions. Each of the following terms has a definition in Article 100 that is unique to its use in “Article xxx”:**

Term 1

Term 2

Term 3

...

**If needed:**

**Informational Note No. y: Definitions. Each of the following terms has a definition in Article 100 that appears in several articles but is important in its use in “Article xxx”:**

Term a

Term b

Term c

...

**Format B – the style used in several places within the NEC itself:**

**Informational Note: See Article 100 for definitions of Term 1, Term 2, and Term 3 . . .**

### Statement of Problem and Substantiation for Public Input

The change to locations of definitions in the 2023 Edition of the NEC was controversial for many people because it reduced usability. Even though other NFPA codes and standards use this structure and was stated as a justification to the change in the ‘NEC Style Manual’ (some NFPA codes and standards include definitions within articles \*), many believe this relocation leads to confusion among users, especially for those articles that are specialty topics – i.e., the articles in Chapters 5 through 8. There are over 37 pages of definitions in Article 100 to search through.

Common language terms often have more specific meanings within an article. One only needs to look at the multiple definitions for ‘Portable Equipment’ to get a sense of this issue. While the term ‘Directly Controlled Emergency Luminaire’ used in Article 700 seems self-explanatory, the actual definition is quite important. Without the proximate reference within Article 700, that distinction is not clear.

Article 200 does the following:

200.1 Scope.

This article provides requirements for the following:

- (1) Identification of terminals
- (2) Grounded conductors in premises wiring systems
- (3) Identification of grounded conductors

Informational Note: See Article 100 for definitions of Grounded Conductor, Equipment Grounding Conductor, and Grounding Electrode Conductor.

Article 380 also adds a definition reference in an Informational Note to the scope.

There are approximately 30 references to Article 100 definitions within specific sections of the Code.

Under the current structure, important specialty definitions are lost in the sheer size of the Article 100 list. The usability of the NEC has been damaged, and users of specialty articles in Chapters 5 through 8 need help with this structure.

To restore the usability of the NEC, what is needed is a way to clearly identify and point to specialty definitions in a standardized location within articles (like we used to have with the .2 sections), while leaving the definitions themselves in Article 100. NFPA Link and the NEC Handbook add this information as Enhanced Content. Additionally, this “definition identification” model has proven its usability in other codes such as NFPA 1, NFPA 99, and NFPA 101. The NEC deserves no less.

\* Example: NFPA 101 – Section 6.1.2.1 ‘Assembly Occupancy’ is one of several definitions in an Article; and in this instance it is duplicated from 3.3.205.2]. In fact, there are multiple definitions throughout NFPA 101.

### Submitter Information Verification

**Submitter Full Name:** Mitchell Hefter

**Organization:** Signify

**Street Address:**

**City:**

**State:**

**Zip:**

**Submittal Date:** Tue Aug 29 11:45:19 EDT 2023

**Committee:** NEC-P15



## Public Input No. 2999-NFPA 70-2023 [ Definition: Alternate Power Source. ]

### Alternate Power Source Sources .

~~One A system of one or more generator sets, or battery systems where permitted, off-site or one or more on-site power generation or storage components intended to provide power during the interruption of the normal electrical service; or the public utility electrical service intended to provide power during interruption of service normally provided by the generating facilities on the premises to nonessential electrical loads and the essential electrical system . [99:3.3.4 155] (517 ELS) - (CMP-15)~~

### Statement of Problem and Substantiation for Public Input

This public input is submitted on behalf of the Microgrid Task Group formed under the direction of the ELS Committee of NFPA 99 to provide correlation input to CMP-15 related to the use of microgrids and distributed energy resources in health care. The TG is also providing public inputs for consideration on any extracted language from 99 that has been modified in the 2024 edition of NFPA 99.

This proposes to delete the definition of "Alternate Power Source" in favor of the definition created by the ELS Committee of 99 for "Power Sources". The Task Group has issued a series of public inputs to remove the terms "alternate" and "normal" from 517 in favor of more generic references to "power sources" (on-site, off-site, etc.). If accepted, the term "Alternate Power Source" is no longer needed but a definition for "Power Sources" needs to be added.

### Submitter Information Verification

**Submitter Full Name:** Chris Finen  
**Organization:** Eaton Corporation  
**Street Address:**  
**City:**  
**State:**  
**Zip:**  
**Submittal Date:** Mon Aug 28 15:21:29 EDT 2023  
**Committee:** NEC-P15



## Public Input No. 3608-NFPA 70-2023 [ Definition: Alternate Power Source. ]

### **Alternate Power Source.**

One or more generator sets, or battery systems where permitted, intended to provide power during the interruption of the normal electrical service; or the public utility electrical service intended to provide power during interruption of service normally provided by the generating facilities on the premises. [ **99: 3-3.4**] (517) (CMP-15)

### **Statement of Problem and Substantiation for Public Input**

NFPA 99 eliminated this definition.

### **Submitter Information Verification**

**Submitter Full Name:** Walter Vernon

**Organization:** Mazzetti

**Street Address:**

**City:**

**State:**

**Zip:**

**Submittal Date:** Tue Sep 05 06:21:05 EDT 2023

**Committee:** NEC-P15



## Public Input No. 2299-NFPA 70-2023 [ Definition: Battery-Powered Lighting Units. ]

### **Battery-Powered Lighting Units.**

Individual unit equipment for backup illumination consisting of a rechargeable battery; a battery-charging means; provisions for one or more lamps mounted on the equipment, or with terminals for remote lamps, or both; and a relaying device arranged to energize the lamps automatically upon failure of the supply to the unit equipment. (517) (CMP-15)

### Statement of Problem and Substantiation for Public Input

The NEC 100 definition of “battery-powered lighting units”, associated with Art. 517, describes the design and intended function of equipment well-known within the emergency lighting community as “unit equipment.” In the 2023 revision cycle, unit equipment was recognized as a type of battery-equipped emergency luminaire, and the (relocated to Article 100) definition was updated accordingly. To promote the consistent use of terminology throughout the NEC, the term “battery-powered lighting unit” should be replaced with the broader term “battery-equipped emergency luminaire” because the intended functionality – to automatically illuminate when the monitored normal power circuit is disrupted – can be accomplished by more than just unit equipment.

See also related PIs 2300 (517.33(E)) and 2301 (517.63(A))

### Related Public Inputs for This Document

<u>Related Input</u>	<u>Relationship</u>
<a href="#">Public Input No. 2300-NFPA 70-2023 [Section No. 517.33(E)]</a>	
<a href="#">Public Input No. 2301-NFPA 70-2023 [Section No. 517.63(A)]</a>	
<a href="#">Public Input No. 2300-NFPA 70-2023 [Section No. 517.33(E)]</a>	
<a href="#">Public Input No. 2301-NFPA 70-2023 [Section No. 517.63(A)]</a>	

### Submitter Information Verification

**Submitter Full Name:** Michael Shulman  
**Organization:** UL Solutions  
**Street Address:**  
**City:**  
**State:**  
**Zip:**  
**Submittal Date:** Tue Aug 15 17:56:02 EDT 2023  
**Committee:** NEC-P15



## Public Input No. 3609-NFPA 70-2023 [ Definition: Essential Electrical System. ]

### Essential Electrical System.

A system comprised of ~~alternate power sources and all~~ of all connected distribution systems and ancillary equipment, designed to ensure continuity of electrical power to designated areas and functions of a health care facility ~~during disruption of normal power sources~~ , and ~~also~~ to minimize disruption within the internal wiring system. [99:3.3.52] (517) (CMP-15)

### Statement of Problem and Substantiation for Public Input

The source is not part of the system. Deletes reference to normal power.

### Submitter Information Verification

**Submitter Full Name:** Walter Vernon

**Organization:** Mazzetti

**Street Address:**

**City:**

**State:**

**Zip:**

**Submittal Date:** Tue Sep 05 06:25:47 EDT 2023

**Committee:** NEC-P15



## Public Input No. 737-NFPA 70-2023 [ Definition: Two-Fer. ]

### **Two-Fer Twofer .**

An assembly containing one male plug and two female cord connectors used to connect two loads to one branch circuit. (520) (CMP-15)

### **Statement of Problem and Substantiation for Public Input**

"-fer" is a word root, and the term referred to is spelled "twofer" as standard in all major English dictionaries as well as electrical manufacturers.

### **Submitter Information Verification**

**Submitter Full Name:** Conrad Ko

**Organization:** [ Not Specified ]

**Street Address:**

**City:**

**State:**

**Zip:**

**Submittal Date:** Wed Apr 26 02:10:19 EDT 2023

**Committee:** NEC-P15





## Public Input No. 2585-NFPA 70-2023 [ New Definition after Definition: Dental Office. ]

Deploy (Deployed ).

The use of portable equipment for the duration required by the event or production for which it is used. (CMP 15).

### Statement of Problem and Substantiation for Public Input

The words “install” / “installed” are normally associated with permanent installations. Portable equipment is not permanently installed in venues covered by the “Entertainment Industry” Articles 518, 520, 525, and 530. Use of the words “deploy” / “deployed” is more descriptive of the portable equipment use and prevents misinterpretation. It also provides additional distinction from Article 590 – Temporary Installations which is often erroneously applied to portable equipment deployed under the Entertainment Articles.

This PI was created by an unofficial task group consisting of:

Steve Terry CMP15  
 Wendy Russell CMP15  
 Mitch Hefter CMP15  
 Hans Lau IATSE Local 728  
 Alan Rowe CMP15  
 Mike Skinner CMP15  
 Jason Potterf CMP18  
 Bill Ellis CMP18  
 Duane Wilson CMP15

### Related Public Inputs for This Document

<u>Related Input</u>	<u>Relationship</u>
<a href="#">Public Input No. 2587-NFPA 70-2023 [Section No. 525.1]</a>	Use of Deploy
<a href="#">Public Input No. 2586-NFPA 70-2023 [Section No. 520.68(D)]</a>	Use of Deploy
<a href="#">Public Input No. 2588-NFPA 70-2023 [Section No. 525.3(A)]</a>	Use of Deploy
<a href="#">Public Input No. 2212-NFPA 70-2023 [Section No. 520.10]</a>	Use of Deploy
<a href="#">Public Input No. 2213-NFPA 70-2023 [Section No. 530.21(B)]</a>	Use of Deploy
<a href="#">Public Input No. 2212-NFPA 70-2023 [Section No. 520.10]</a>	
<a href="#">Public Input No. 2213-NFPA 70-2023 [Section No. 530.21(B)]</a>	
<a href="#">Public Input No. 2586-NFPA 70-2023 [Section No. 520.68(D)]</a>	
<a href="#">Public Input No. 2587-NFPA 70-2023 [Section No. 525.1]</a>	
<a href="#">Public Input No. 2588-NFPA 70-2023 [Section No. 525.3(A)]</a>	

### Submitter Information Verification

**Submitter Full Name:** Steven Terry  
**Organization:** Electronic Theatre Controls In  
**Affiliation:** US Institute for Theatre Technology

**Street Address:**

**City:**

**State:**

**Zip:**

**Submittal Date:** Wed Aug 23 11:26:31 EDT 2023

**Committee:** NEC-P15



## Public Input No. 3232-NFPA 70-2023 [ New Definition after Definition: Motion

Picture Studio (Tel... ]

### TITLE OF NEW CONTENT

Type your content here ...Add new definition in Article 100 for "Motion Picture Studio Sound Stage"

"Motion Picture Studio Sound Stage. A building or portion of a building, usually insulated from outside noise and natural light, designed, constructed, or altered for the purpose of image capture."

### Statement of Problem and Substantiation for Public Input

It appears this definition was inadvertently left out of the 2023 NEC. It was submitted by CMP #15 Task Group #2 during the revision cycle.

### Submitter Information Verification

**Submitter Full Name:** Michael Skinner

**Organization:** Contract Services Administration Trust Fund

**Street Address:**

**City:**

**State:**

**Zip:**

**Submittal Date:** Wed Aug 30 14:55:00 EDT 2023

**Committee:** NEC-P15



## Public Input No. 2211-NFPA 70-2023 [ New Definition after Definition: Pier, Floating. (Floating ... )

### Pinout Configuration.

The assignment of electrical functions to connector pins in a multicircuit connector. (CMP 15)

### Statement of Problem and Substantiation for Public Input

There are multiple multicircuit connectors using varying pinout configurations in wide use in portable equipment in the Entertainment Industry. This new definition coordinates with PI # for section 520.68(D) requiring identification of the configurations.

This PI was created by an unofficial task group consisting of:

Steve Terry CMP15  
 Wendy Russell CMP15  
 Mitch Hefter CMP15  
 Hans Lau IATSE Local 728  
 Alan Rowe CMP15  
 Mike Skinner CMP15  
 Jason Potterf CMP18  
 Bill Ellis CMP18  
 Duane Wilson CMP15

### Related Public Inputs for This Document

<u>Related Input</u>	<u>Relationship</u>
<a href="#">Public Input No. 2586-NFPA 70-2023 [Section No. 520.68(D)]</a>	Use of Pinout Configuration
<a href="#">Public Input No. 2586-NFPA 70-2023 [Section No. 520.68(D)]</a>	

### Submitter Information Verification

**Submitter Full Name:** Steven Terry  
**Organization:** Electronic Theatre Controls In  
**Affiliation:** US Institute for Theatre Technology  
**Street Address:**  
**City:**  
**State:**  
**Zip:**  
**Submittal Date:** Tue Aug 15 09:02:13 EDT 2023  
**Committee:** NEC-P15



## Public Input No. 3607-NFPA 70-2023 [ New Section after 220.110 ]

### 220.111 Specific Appliance Loads

Receptacle loads calculated in accordance with 220.14(A) and supplied by branch circuits not exceeding 150 volts to ground shall be permitted to be subjected to the demand factors provided in Table 220.111 for health care facilities.

#### Table 220.111

<u>Number of circuits</u>	<u>Demand Factor (%)</u>
<u>0-5</u>	<u>100%</u>
<u>6-10</u>	<u>50%</u>
<u>11 or more</u>	<u>25%</u>

### Statement of Problem and Substantiation for Public Input

The current requirements for dedicated circuits result in gross oversizing of electrical systems. This is because so much of the equipment is infrequently used. Prior to the last cycle, the NFPA Foundation performed a study of hospital electrical loads that reached just this conclusion, but with few data points. A subsequent study has been undertaken as a follow-on to that study, with sufficient data points to allow this adjustment to be made with confidence. The study has been overseen by a group of peer reviewers from CMP2, CMP15, and CMP 13. We can present all of the data, including statistical analysis from a PhD who helped to oversee the numerical analysis.

### Submitter Information Verification

**Submitter Full Name:** Walter Vernon

**Organization:** Mazzetti

**Street Address:**

**City:**

**State:**

**Zip:**

**Submittal Date:** Tue Sep 05 06:05:02 EDT 2023

**Committee:** NEC-P15



## Public Input No. 3682-NFPA 70-2023 [ Article 517 ]

### Article 517 Health Care Facilities

#### Part I. General

##### 517.1 Scope.

This article applies to electrical construction and installation criteria in health care facilities that provide services to human beings.

The requirements of this article shall specify the installation criteria and wiring methods that minimize electrical hazards by the maintenance of adequately low potential differences only between exposed conductive surfaces that are likely to become energized and could be contacted by a patient.

Informational Note No. 1: In a health care facility, it is difficult to prevent the occurrence of a conductive or capacitive path from the patient's body to some grounded object, because that path might be established accidentally or through instrumentation directly connected to the patient. Other electrically conductive surfaces that might make an additional contact with the patient, or instruments that might be connected to the patient, then become possible sources of electric currents that can traverse the patient's body. The hazard is increased as more apparatus is associated with the patient, therefore more intensive precautions are needed. Control of electric shock hazard requires the limitation of electric current that might flow in an electrical circuit involving the patient's body by raising the resistance of the conductive circuit that includes the patient, or by insulating exposed conductive surfaces that might become energized, in addition to reducing the potential difference that can appear between exposed conductive surfaces in the patient care vicinity, or by combinations of these methods. A special problem is presented by the patient with an externalized direct conductive path to the heart muscle. The patient could be electrocuted at current levels so low that additional protection in the design of appliances, insulation of the catheter, and control of medical practice is required.

The requirements in Parts II and III not only apply to single-function buildings but are also intended to be individually applied to their respective forms of occupancy within a multifunction building [e.g., a doctor's examining room located within a limited care facility would be required to meet 517.10(A)].

Informational Note No. 2: For information concerning performance, maintenance, and testing criteria, refer to the appropriate health care facilities documents.

Informational Note No. 3: Text that is followed by a reference in brackets has been extracted from NFPA 99-2021, *Health Care Facilities Code*, or NFPA 101-2021, *Life Safety Code*. Only editorial changes were made to the extracted text to make it consistent with this *Code*.

##### 517.6 Patient Care–Related Electrical Equipment.

The reconditioning requirements of this *Code* shall not apply to patient care–related electrical equipment.

Informational Note No. 1: Patient care–related electrical equipment is differentiated from electrical equipment as described in 110.21(A)(2).

Informational Note No. 2: If patient care–related electrical equipment is relocated, it is expected to be recommissioned or recertified in accordance with the U.S. *Federal Food, Drug, and Cosmetic Act (FDCA)*.

#### Part II. Wiring and Protection

##### 517.10 Applicability.

**(A) Applicability.**

Part II shall apply to patient care space of all health care facilities.

**(B) Not Covered.**

Part II shall not apply to the following:

- (1) Business offices, corridors, waiting rooms, and the like in clinics, medical and dental offices, and outpatient facilities
- (2) Spaces of nursing homes and limited care facilities wired in accordance with Chapters 1 through 4 of this *Code* where these spaces are used exclusively as patient sleeping rooms, as determined by the health care facility's governing body

Informational Note No. 1: See 406.12(5) for receptacles located in health care facility business offices, corridors, and waiting rooms that are required to be tamper resistant.

Informational Note No. 2: See 210.12(D) for branch circuits supplying outlets and receptacles located in patient sleeping rooms in nursing homes and limited care facilities that are connected to arc-fault circuit-interrupter circuits.

- (3) Areas used exclusively for any of the following purposes:
  - a. Intramuscular injections (immunizations)
  - b. Psychiatry and psychotherapy
  - c. Alternative medicine
  - d. Optometry
  - e. Pharmacy services not contiguous to health care facilities

Informational Note No. 3: See NFPA 101-2021, *Life Safety Code*.

**517.12 Wiring Methods.**

Except as modified in this article, wiring methods shall comply with Chapters 1 through 4 of this *Code*.

**517.13 Equipment Grounding Conductor for Receptacles and Fixed Electrical Equipment in Patient Care Spaces.**

Wiring serving patient care spaces shall comply with the requirements of 517.13(A) and (B).

*Exception: Luminaires more than 2.3 m (7½ ft) above the floor and switches located outside of the patient care vicinity shall be permitted to be connected to an equipment grounding return path complying with the requirements of 517.13(A) or (B).*

**(A) Wiring Methods.**

All branch circuits serving patient care spaces shall be provided with an effective ground-fault current path by installation in a metal raceway system or a cable having a metallic armor or sheath assembly. The metal raceway system, metallic cable armor, or sheath assembly shall itself qualify as an equipment grounding conductor in accordance with 250.118.

**(B) Insulated Equipment Grounding Conductors and Insulated Equipment Bonding Jumpers.**

**(1) General.**

An insulated copper equipment grounding conductor that is clearly identified along its entire length by green insulation and installed with the branch circuit conductors within the wiring method in accordance with 517.13(A) shall be connected to the following:

- (1) Grounding terminals of all receptacles other than isolated ground receptacles
- (2) Metal outlet boxes, metal device boxes, or metal enclosures
- (3) Non-current-carrying conductive surfaces of fixed electrical equipment likely to become energized that are subject to personal contact, operating at over 100 volts

*Exception No. 1: For other than isolated ground receptacles, an insulated equipment bonding jumper that directly connects to the equipment grounding conductor shall be permitted to connect the box and receptacle(s) to the equipment grounding conductor. Isolated ground receptacles shall be connected in accordance with 517.16.*

*Exception No. 2: Metal faceplates shall be connected to an effective ground-fault current path by means of a metal mounting screw(s) securing the faceplate to a metal yoke or strap of a receptacle or to a metal outlet box.*

**(2) Sizing.**

Equipment grounding conductors and equipment bonding jumpers shall be sized in accordance with 250.122.

**517.14 Panelboard Bonding.**

The equipment grounding terminal buses of the normal and essential branch-circuit panelboards serving the same individual patient care vicinity shall be connected together with an insulated continuous copper conductor not smaller than 10 AWG. Where two or more panelboards serving the same individual patient care vicinity are served from separate transfer switches on the essential electrical system, the equipment grounding terminal buses of those panelboards shall be connected together with an insulated continuous copper conductor not smaller than 10 AWG. This conductor shall be permitted to be broken in order to terminate on the equipment grounding terminal bus in each panelboard.

*Exception: The insulated continuous copper conductor not smaller than 10 AWG shall be permitted to be terminated on listed connections to aluminum or copper busbars not smaller than 6 mm thick × 50 mm wide (¼ in. thick × 2 in. wide) and of sufficient length to accommodate the number of terminations necessary for the bonding of the panelboards. The busbar shall be securely fastened and installed in an accessible location.*

**517.16 Use of Isolated Ground Receptacles.**

An isolated ground receptacle, if used, shall not defeat the purposes of the safety features of the grounding systems detailed in 517.13. [99:6.3.2.2.5(A)]

**(A) Inside of a Patient Care Vicinity.**

An isolated ground receptacle shall not be installed within a patient care vicinity. [99:6.3.2.2.5(B)]

**(B) Outside of a Patient Care Vicinity.**

Isolated ground receptacle(s) installed in patient care spaces outside of a patient care vicinity(s) shall comply with 517.16(B)(1) and (B)(2).

**(1)**

The equipment grounding terminals of isolated ground receptacles installed in branch circuits for patient care spaces shall be connected to an insulated equipment grounding conductor in accordance with 250.146(D) installed in a wiring method described in 517.13(A).

The equipment grounding conductor connected to the equipment grounding terminals of isolated ground receptacles in patient care spaces shall be clearly identified along the equipment grounding conductor's entire length by green insulation with one or more yellow stripes.



**(2)**

The insulated equipment grounding conductor required in 517.13(B)(1) shall be clearly identified along its entire length by green insulation, with no yellow stripes, and shall not be connected to the grounding terminals of isolated equipment ground receptacles but shall be connected to the box or enclosure indicated in 517.13(B)(1)(2) and to non-current-carrying conductive surfaces of fixed electrical equipment indicated in 517.13(B)(1)(3).

Informational Note No. 1: This type of installation is typically used where a reduction of electrical noise (electromagnetic interference) is necessary, and parallel grounding paths are to be avoided.

Informational Note No. 2: Care should be taken in specifying a system containing isolated ground receptacles, because the impedance of the effective ground-fault current path is dependent upon the equipment grounding conductor(s) and does not benefit from any conduit or building structure in parallel with the equipment grounding conductor.

**517.17** Ground-Fault Protection of Equipment.**(A)** Applicability.

The requirements of 517.17 shall apply to buildings or portions of buildings containing health care facilities with Category 1 spaces or utilizing electrical life-support equipment, and buildings that provide the required essential utilities or services for the operation of Category 1 spaces or electrical life-support equipment.

**(B)** Feeders.

Where ground-fault protection of equipment is provided for operation of the service disconnecting means or feeder disconnecting means as specified by 230.95 or 215.10, an additional step of ground-fault protection shall be provided in all next level feeder disconnecting means downstream toward the load. Such protection shall consist of overcurrent devices and current transformers or other protective equipment that shall cause the feeder disconnecting means to open.

The additional levels of ground-fault protection of equipment shall not be installed on the load side of an essential electrical system transfer switch.

**(C)** Selectivity.

Ground-fault protection of equipment for operation of the service and feeder disconnecting means shall be fully selective such that the feeder device, but not the service device, shall open on ground faults on the load side of the feeder device. Separation of ground-fault protection time-current characteristics shall conform to manufacturer's recommendations and shall consider all required tolerances and disconnect operating time to achieve 100 percent selectivity.

Informational Note: See 230.95, Informational Note, for transfer of alternate source where ground-fault protection is applied.

**(D)** Testing.

When ground-fault protection of equipment is first installed, each level shall be performance tested to ensure compliance with 517.17(C). This testing shall be conducted by a qualified person(s) using a test process in accordance with the instruction provided with the equipment. A written record of this testing shall be made and shall be available to the authority having jurisdiction.

**517.18** Category 2 Spaces.

**(A) Patient Bed Location.**

Each patient bed location shall be supplied by at least two branch circuits, one from the critical branch and one from the normal system. All branch circuits from the normal system shall originate in the same panelboard. The electrical receptacles or the cover plate for the electrical receptacles supplied from the critical branch shall have a distinctive color or marking so as to be readily identifiable and shall also indicate the panelboard and branch-circuit number supplying them.

Branch circuits serving patient bed locations shall not be part of a multiwire branch circuit.

*Exception No. 1: Branch circuits serving only special-purpose outlets or receptacles, such as portable X-ray outlets, shall not be required to be served from the same distribution panel or panels.*

*Exception No. 2: The requirements of 517.18(A) shall not apply to patient bed locations in clinics, medical and dental offices, and outpatient facilities; psychiatric, substance abuse, and rehabilitation hospitals; sleeping rooms of nursing homes; and limited care facilities meeting the requirements of 517.10(B)(2).*

*Exception No. 3: A Category 2 patient bed location served from two separate transfer switches on the critical branch shall not be required to have circuits from the normal system.*

*Exception No. 4: Circuits served by Type 2 essential electrical systems shall be permitted to be fed by the equipment branch of the essential electrical system.*

**(B) Patient Bed Location Receptacles.****(1) Minimum Number and Supply.**

Each patient bed location shall be provided with a minimum of eight receptacles.

**(2) Receptacle Requirements.**

The receptacles required in 517.18(B)(1) shall be permitted to be of the single, duplex, or quadruplex type or any combination of the three. All receptacles shall be listed "hospital grade" and shall be so identified. The grounding terminal of each receptacle shall be connected to an insulated copper equipment grounding conductor sized in accordance with Table 250.122.

*Exception No. 1: The requirements of 517.18(B)(1) and (B)(2) shall not apply to psychiatric, substance abuse, and rehabilitation hospitals meeting the requirements of 517.10(B)(2).*

*Exception No. 2: Psychiatric security rooms shall not be required to have receptacle outlets installed in the room.*

Informational Note: It is not intended that there be a total, immediate replacement of existing non-hospital grade receptacles. It is intended, however, that non-hospital grade receptacles be replaced with hospital grade receptacles upon modification of use, renovation, or as existing receptacles need replacement.

**(C) Designated Category 2 Pediatric Locations.**

Receptacles that are located within patient rooms, bathrooms, playrooms, and activity rooms of pediatric units or spaces with similar risk as determined by the health care facility's governing body by conducting a risk assessment, other than infant nurseries, shall be listed and identified as "tamper resistant" or shall employ a listed tamper-resistant cover. [99:6.3.2.2.1(D)]

**517.19 Category 1 Spaces.**

**(A) Patient Bed Location Branch Circuits.**

Each patient bed location shall be supplied by at least two branch circuits, one or more from the critical branch and one or more from the normal system. At least one branch circuit from the critical branch shall supply an outlet(s) only at that bed location.

The electrical receptacles or the cover plates for the electrical receptacles supplied from the life safety and critical branches shall have a distinctive color or marking so as to be readily identifiable. [99:6.7.2.2.5(B)]

All branch circuits from the normal system shall be from a single panelboard. Critical branch receptacles shall be identified and shall also indicate the panelboard and circuit number supplying them.

Branch circuits serving patient bed locations shall not be part of a multiwire branch circuit.

*Exception No. 1: Branch circuits serving only special-purpose receptacles or equipment in Category 1 spaces shall be permitted to be served by other panelboards.*

*Exception No. 2: Category 1 spaces served from two separate critical branch transfer switches shall not be required to have circuits from the normal system.*

**(B) Patient Bed Location Receptacles.****(1) Minimum Number and Supply.**

Each patient bed location shall be provided with a minimum of 14 receptacles, with at least one connected to either of the following:

- (1) The normal system branch circuit required in 517.19(A)
- (2) A critical branch circuit supplied by a different transfer switch than the other receptacles at the same patient bed location

**(2) Receptacle Requirements.**

The receptacles required in 517.19(B)(1) shall be permitted to be of the single, duplex, or quadruplex type or any combination of the three. All receptacles shall be listed "hospital grade" and shall be so identified. The grounding terminal of each receptacle shall be connected to the reference grounding point by means of an insulated copper equipment grounding conductor.

**(C) Operating Room Receptacles.****(1) Minimum Number and Supply.**

Each operating room shall be provided with a minimum of 36 receptacles divided between at least two branch circuits. At least 12 receptacles, but no more than 24, shall be connected to either of the following:

- (1) The normal system branch circuit required in 517.19(A)
- (2) A critical branch circuit supplied by a different transfer switch than the other receptacles at the same location

**(2) Receptacle Requirements.**

The receptacles shall be permitted to be of the locking or nonlocking type and of the single, duplex, or quadruplex types or any combination of the three.

All nonlocking-type receptacles shall be listed hospital grade and so identified. The grounding terminal of each receptacle shall be connected to the reference grounding point by means of an insulated copper equipment grounding conductor.

**(D) Patient Care Vicinity Grounding and Bonding (Optional).**

A patient care vicinity shall be permitted to have a patient equipment grounding point. The patient equipment grounding point, where supplied, shall be permitted to contain one or more listed grounding and bonding jacks. An equipment bonding jumper not smaller than 10 AWG shall be used to connect the grounding terminal of all grounding-type receptacles to the patient equipment grounding point. The bonding conductor shall be permitted to be arranged centrally or looped as convenient.

Informational Note: Where there is no patient equipment grounding point, it is important that the distance between the reference grounding point and the patient care vicinity be as short as possible to minimize any potential differences.

**(E) Equipment Grounding and Bonding.**

Where a grounded electrical distribution system is used and metal feeder raceway or Type MC or MI cable that qualifies as an equipment grounding conductor in accordance with 250.118 is installed, grounding of enclosures and equipment, such as panelboards, switchboards, and switchgear, shall be ensured by one of the following bonding means at each termination or junction point of the metal raceway or Type MC or MI cable:

- (1) A grounding bushing and a continuous copper bonding jumper, sized in accordance with 250.122, with the bonding jumper connected to the junction enclosure or the ground bus of the panel
- (2) Connection of feeder raceways or Type MC or MI cable to threaded hubs or bosses on terminating enclosures
- (3) Other approved devices such as bonding-type locknuts or bushings. Standard locknuts shall not be used for bonding.

**(F) Additional Protective Techniques in Category 1 Spaces (Optional).**

Isolated power systems shall be permitted to be used for Category 1 spaces, and, if used, the isolated power system equipment shall be listed as isolated power equipment. The isolated power system shall be designed and installed in accordance with 517.160.

*Exception: The audible and visual indicators of the line isolation monitor shall be permitted to be located at the nursing station for the area being served.*

**(G) Isolated Power System Equipment Grounding.**

Where an isolated ungrounded power source is used and limits the first-fault current to a low magnitude, the equipment grounding conductor associated with the secondary circuit shall be permitted to be run outside of the enclosure of the power conductors in the same circuit.

Informational Note: Although it is permitted to run the equipment grounding conductor outside of the conduit, it is safer to run it with the power conductors to provide better protection in case of a second ground fault.

**(H) Special-Purpose Receptacle Grounding.**

The equipment grounding conductor for special-purpose receptacles, such as the operation of mobile X-ray equipment, shall be extended to the reference grounding points of branch circuits for all locations likely to be served from such receptacles. Where such a circuit is served from an isolated ungrounded system, the equipment grounding conductor shall not be required to be run with the power conductors; however, the equipment grounding terminal of the special-purpose receptacle shall be connected to the reference grounding point.

**517.20 Wet Procedure Locations.**

**(A) Receptacles and Fixed Equipment.**

Wet procedure locations shall be provided with special protection against electric shock.

[99:6.3.2.3.1]

This special protection shall be provided by one of the following:

- (1) Isolated power systems that remain in operation in the event of a single line-to-ground fault condition that inherently limits the possible ground-fault current due to a first fault to a low value, without interrupting the power supply

Informational Note No. 1: Isolated power systems can eliminate the danger of electric shock to patients who might be more susceptible to leakage current and unable to move in their beds.

- (2) Power distribution system in which the power supply is interrupted if the ground-fault current does, in fact, exceed the trip value of a Class A GFCI

Informational Note No. 2: See Annex E of ANSI/UL 943-2018, *Ground-Fault Circuit-Interrupters*, and 110.3(B) for the manufacturers' installation instructions of listed ground-fault circuit interrupters for information on the supply connection of life-support equipment to circuits providing ground-fault circuit-interrupter (GFCI) protection of personnel at outlets.

[99:6.3.2.3.2]

*Exception: Branch circuits supplying only listed, fixed, therapeutic, and diagnostic equipment shall be permitted to be supplied from a grounded service, single- or 3-phase system if the following conditions are met:*

- (1) *Wiring for grounded and isolated circuits does not occupy the same raceway.*
- (2) *All conductive surfaces of the equipment are connected to an insulated copper equipment grounding conductor.*

**(B) Isolated Power Systems.**

Where an isolated power system is utilized, the isolated power equipment shall be listed as isolated power equipment, and the isolated power system shall be designed and installed in accordance with 517.160.

Informational Note: See Part IV of Article 680 for requirements on the installation of therapeutic pools and tubs.

**517.21 Ground-Fault Circuit-Interrupter Protection for Personnel in Category 2 and Category 1 Spaces.**

Receptacles shall not be required in bathrooms or toilet rooms. [99:6.3.2.2.2(D)]

Receptacles located in patient bathrooms and toilet rooms in Category 2 spaces shall have ground-fault circuit-interrupter protection in accordance with 210.8(B)(1).

Ground-fault circuit-interrupter protection for personnel shall not be required for receptacles installed in those Category 2 and Category 1 spaces where a basin, sink, or other similar plumbing fixture is installed in the patient bed location.

Informational Note: See ANSI/UL 943-2018, *Ground-Fault Circuit-Interrupters*, Annex E, and, in accordance with 110.3(B), the manufacturers' installation instructions of listed ground-fault circuit interrupters for information on the supply connection of life-support equipment to circuits providing ground-fault circuit-interrupter (GFCI) protection of personnel at outlets.

**517.22 Demand Factors.**

Demand factors for receptacle loads supplied by branch circuits not exceeding 150 volts to ground and installed in Category 1, Category 2, Category 3, and Category 4 patient care spaces shall be in accordance with 220.110.

Informational Note: See Article 100 for the definitions of patient care space categories.

**Part III. Essential Electrical System (EES)****517.25 Essential Electrical Systems for Health Care Facilities.**

Type 1 and Type 2 essential electrical systems (EES) for health care facilities shall comprise separate branches capable of supplying a limited amount of lighting and power service, which is considered essential for life safety and orderly cessation of procedures during the time normal electrical service is interrupted for any reason.

Informational Note: See NFPA 99-2021, *Health Care Facilities Code*, for information on essential electrical systems.

**517.26 Application of Other Articles.**

The life safety branch of the essential electrical system shall meet the requirements of Article 700, except as amended as follows:

- (1) Section 700.4 shall not apply.
- (2) Section 700.10(D) shall not apply.
- (3) Section 700.17 shall be replaced with the following: Branch circuits that supply emergency lighting shall be installed to provide service from a source in accordance with 700.12 when normal supply for lighting is interrupted or where single circuits supply luminaires containing secondary batteries.
- (4) Section 700.32 shall not apply.

Informational Note No. 1: See NFPA 110-2019, *Standard for Emergency and Standby Power Systems*, for additional information.

Informational Note No. 2: See 517.29 and NFPA 99-2021, *Health Care Facilities Code*, for additional information.

**517.29 Type 1 Essential Electrical Systems.**

Informational Note: Type 1 essential electrical systems are comprised of three separate branches capable of supplying a limited amount of lighting and power service that is considered essential for life safety and effective facility operation during the time the normal electrical service is interrupted for any reason. These three separate branches are the life safety, critical, and equipment branches. [99:A.6.7.2.3]

**(A) Applicability.**

The requirements of 517.29 through 517.35 shall apply to Type 1 essential electrical systems. Type 1 systems shall be required for Category 1 spaces. Type 1 systems shall be permitted to serve Category 2, Category 3, and Category 4 spaces.

Informational Note No. 1: See NFPA 99-2021, *Health Care Facilities Code*, for performance, maintenance, and testing requirements of essential electrical systems in hospitals. See NFPA 20-2019, *Standard for the Installation of Stationary Pumps for Fire Protection*, for installation of centrifugal fire pumps.

Informational Note No. 2: See NFPA 99-2021, *Health Care Facilities Code*, 6.7.5 and 6.7.6, for additional information on Type 1 and Type 2 essential electrical systems.

**(B) Type 1 Essential Electrical Systems.**

Category 1 spaces shall be served by a Type 1 essential electrical system. [99:6.4.1]

Category 1 spaces shall not be served by a Type 2 EES. [99:6.4.2]

**517.30 Sources of Power.**

**(A) Two Independent Power Sources.**

Essential electrical systems (EES) shall have two or more independent sources (or sets of sources). One on-site source (or sets of sources) shall be sized to supply the entire EES. The other independent source (or sets of sources) shall be sized to supply the entire EES and shall be permitted to be located on-site or off-site. Additional sources other than the first two independent sources shall be permitted to be sized to supply the intended load.

Informational Note: An example of a set of sources may be several generators that combined serve the entire EES.

**(B) Power Sources for the EES.**

Power sources for the EES shall be permitted to be any of those specified in 517.30(B)(1) through (B)(5).

**(1) Utility Supply Power.**

Where utility power is used as the normal source, utility power shall not be used as the alternate source unless permitted elsewhere in this article.

Informational Note: See 517.35 and 517.45 for essential system loads that can be supplied from dual sources of utility supply power.

**(2) Generating Units.****(3) Fuel Cell Systems.**

Fuel cell systems shall be permitted to serve as the alternate power source for all or part of an EES. [99:6.7.1.5.1]

(a) Installation of fuel cells shall comply with the requirements in Parts I through VII of Article 692 for 1000 volts or less and Part VIII for over 1000 volts.

(b)  $N + 1$  units shall be provided where  $N$  units have sufficient capacity to supply the demand load of the portion of the system served.

(c) Systems shall be able to assume loads within 10 seconds of loss of normal power source.

(d) Systems shall have a continuing source of fuel supply, together with sufficient on-site fuel storage for the essential system type.

(e) Where life safety and critical portions of the distribution system are present, a connection shall be provided for a portable diesel generator.

Informational Note: See NFPA 853-2020, *Standard for the Installation of Stationary Fuel Cell Power Systems*, for information on installation of stationary fuel cells.

**(4) Energy Storage Systems.**

Energy storage systems shall be permitted to serve as the alternate source for all or part of an EES.

Informational Note: See NFPA 111-2022, *Standard on Stored Electrical Energy Emergency and Standby Power Systems*, for information on the installation of energy storage systems.

**(5) Health Care Microgrid.**

EES shall be permitted to be supplied by a health care microgrid that also supplies nonessential loads. The health care microgrid shall be permitted to share distributed resources with the normal system. Health care microgrid systems shall be designed with sufficient reliability to provide effective facility operation consistent with the facility emergency operations plan. Health care microgrid system components shall not be compromised by failure of the normal source.

Informational Note: See NFPA 99-2021, *Health Care Facilities Code*, for information on health care microgrids.

**(C) Location of EES Components.**

EES components shall be located to minimize interruptions caused by natural forces common to the area (e.g., storms, floods, earthquakes, or hazards created by adjoining structures or activities). [99:6.2.4.1]

**(1) Services.**

Installation of electrical service distribution equipment shall be located to reduce possible interruption of normal electrical services resulting from natural or manmade causes as well as internal wiring and equipment failures.

**(2) Feeders.**

Feeders shall be located to provide physical separation of the feeders of the alternate source and from the feeders of the normal electrical source to prevent possible simultaneous interruption. [99:6.2.4.3]

Informational Note: Facilities in which the normal source of power is supplied by two or more separate central station-fed services experience greater than normal electrical service reliability than those with only a single feed. Such a dual source of normal power consists of two or more electrical services fed from separate generator sets or a utility distribution network that has multiple power input sources and is arranged to provide mechanical and electrical separation so that a fault between the facility and the generating sources is not likely to cause an interruption of more than one of the facility service feeders.

**517.31 Requirements for the Essential Electrical System.****(A) Separate Branches.**

Type 1 essential electrical systems shall be comprised of three separate branches capable of supplying a limited amount of lighting and power service that is considered essential for life safety and effective hospital operation during the time the normal electrical service is interrupted for any reason. The three branches are life safety, critical, and equipment.

The division between the branches shall occur at transfer switches where more than one transfer switch is required. [99:6.7.2.3.1]

**(B) Transfer Switches.**



Transfer switches shall be in accordance with one of the following:

- (1) The number of transfer switches to be used shall be based on reliability and design. Each branch of the essential electrical system shall have one or more transfer switches.
- (2) One transfer switch shall be permitted to serve one or more branches in a facility with a continuous load on the switch of 150 kVA (120 kW) or less. [99:6.7.6.2.1.4]

Informational Note No. 1: See NFPA 99-2021, *Health Care Facilities Code*, 6.7.3.1, 6.7.2.2.5, 6.7.2.2.5.15, and 6.7.2.2.7, for more information on transfer switches.

Informational Note No. 2: See Informational Note Figure 517.31(B)(1).

Informational Note No. 3: See Informational Note Figure 517.31(B)(2).

**Figure Informational Note Figure 517.31(B)(1) Type 1 Essential Electrical System — Minimum Requirement (Greater Than 150 kVA) for Transfer Switch Arrangement.**

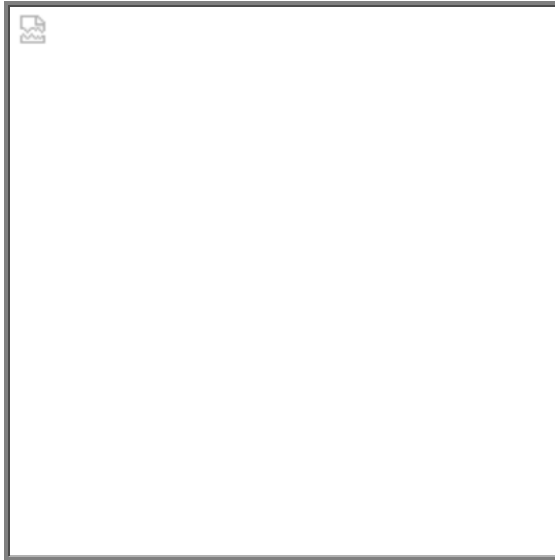

**Figure Informational Note Figure 517.31(B)(2) Type 1 Essential Electrical System — Minimum Requirement (150 kVA or Less) for Transfer Switch Arrangement.**

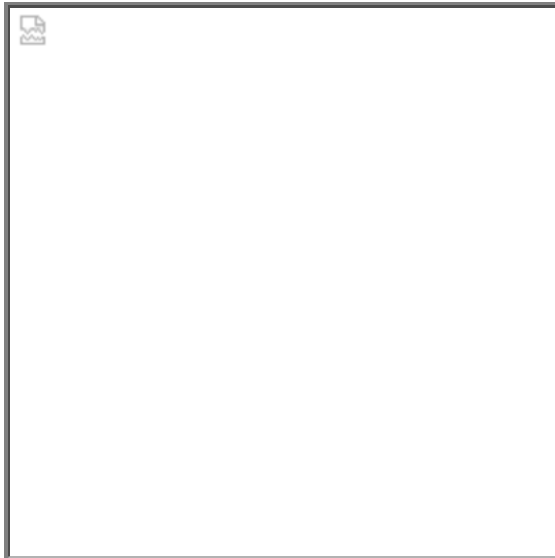

**(1) Optional Loads.**

Loads served by the generating equipment not specifically named in this article shall be served by their own transfer switches such that the following conditions apply:

- (1) These loads shall not be transferred if the transfer will overload the generating equipment.
- (2) These loads shall be automatically shed upon generating equipment overloading.

**(2) Contiguous Facilities.**

Hospital power sources and alternate power sources shall be permitted to serve the essential electrical systems of contiguous or same-site facilities.

**(C) Wiring Requirements.****(1) Separation from Other Circuits.**

The life safety branch and critical branch [of the essential electrical system] shall be kept independent of all other wiring and equipment. [99:6.7.5.2.1]

(a) Raceways, cables, or enclosures of the life safety and critical branch shall be readily identified as components of the essential electrical system (EES). Boxes and enclosures (including transfer switches, generators, and power panels) shall be field- or factory-marked and identified as components of the EES. Raceways and cables shall be field- or factory-marked as components of the EES at intervals not to exceed 7.6 m (25 ft).

(b) Conductors of the life safety branch or critical branch shall not enter the same raceways, boxes, or cabinets with each other or any other wiring system. Branch conductors shall be permitted to occupy common equipment, raceways, boxes, or cabinets of other circuits not part of the life safety branch and critical branch where such wiring complies with one of the following:

- (1) Is in transfer equipment enclosures
- (2) Is in exit or emergency luminaires supplied from two sources
- (3) Is in a common junction box attached to exit or emergency luminaires supplied from two sources
- (4) Is for two or more circuits supplied from the same branch and same transfer switch

(c) The wiring of the equipment branch shall be permitted to occupy the same raceways, boxes, or cabinets of other circuits that are not part of the essential electrical system.

(d) Where Category 2 locations are served from two separate transfer switches on the essential electrical system in accordance with 517.18(A), Exception No. 3, the Category 2 circuits from the two separate systems shall be kept independent of each other.

(e) Where Category 1 locations are served from two separate transfer switches on the essential electrical system in accordance with 517.19(A), Exception No. 2, the critical care circuits from the two separate systems shall be kept independent of each other.

**(2) Isolated Power Systems.**

Where isolated power systems are installed in any of the areas in 517.34(A)(1) and (A)(2), each system shall be supplied by an individual circuit serving no other load.

**(3) Mechanical Protection of the Essential Electrical System.**

The wiring of the life safety and critical branches shall be mechanically protected by raceways. Where installed as branch circuits in patient care spaces, the installation shall comply with the requirements of 517.13(A) and (B) and 250.118. Only the following wiring methods shall be permitted:

- (1) Nonflexible metal raceways, Type MI cable, RTRC marked with the suffix -XW, or Schedule 80 PVC conduit. Nonmetallic raceways shall not be used for branch circuits that supply patient care spaces.
- (2) Where encased in not less than 50 mm (2 in.) of concrete, Schedule 40 PVC conduit, flexible nonmetallic or jacketed metallic raceways, or jacketed metallic cable assemblies listed for installation in concrete. Nonmetallic raceways shall not be used for branch circuits that supply patient care spaces.
- (3) Listed flexible metal raceways and listed metal sheathed cable assemblies, as follows:
  - a. Where used in listed prefabricated medical headwalls
  - b. In listed office furnishings
  - c. Where fished into existing walls or ceilings, not otherwise accessible and not subject to physical damage
  - d. Where necessary for flexible connection to equipment
  - e. For equipment that requires a flexible connection due to movement, vibration, or operation
  - f. Luminaires installed in ceiling structures
- (4) Flexible power cords of appliances or other utilization equipment connected to the essential electrical system.
- (5) Cables for Class 2 or Class 3 systems permitted in Part VI of this article, with or without raceways.

Informational Note: See 517.13 for additional grounding requirements in patient care areas.

**(D) Capacity of Systems.**

The essential electrical system shall have the capacity and rating to meet the maximum actual demand likely to be produced by the connected load.

Feeders shall be sized in accordance with 215.2 and Part III of Article 220. The alternate power source(s) required in 517.30 shall have the capacity and rating to meet the demand produced by the load at any given time.

Demand calculations for sizing of the alternate power source(s) shall be based on any of the following:

- (1) Prudent demand factors and historical data
- (2) Connected load
- (3) Feeder calculations
- (4) Any combination of the above

The sizing requirements in 700.4 and 701.4 shall not apply to alternate sources.

**(E) Receptacle Identification.**

The electrical receptacles or the cover plates for the electrical receptacles supplied from the life safety and critical branches shall have a distinctive color or marking so as to be readily identifiable. [99:6.7.2.2.5(B)]

**(F) Feeders from Alternate Power Source.**

A single feeder supplied by a local or remote alternate power source shall be permitted to supply the essential electrical system to the point at which the life safety, critical, and equipment branches are separated. Installation of the transfer equipment shall be permitted at other than the location of the alternate power source.

**(G) Coordination.**

Overcurrent protective devices serving the essential electrical system shall be coordinated for the period of time that a fault's duration extends beyond 0.1 second.

*Exception No. 1: Coordination shall not be required between transformer primary and secondary overcurrent protective devices where only one overcurrent protective device or set of overcurrent protective devices exists on the transformer secondary.*

*Exception No. 2: Coordination shall not be required between overcurrent protective devices of the same size (ampere rating) in series.*

Informational Note No. 1: The terms *coordination* and *coordinated* as used in this section do not cover the full range of overcurrent conditions.

Informational Note No. 2: See 517.17(C) for information on requirements for the coordination of ground-fault protection.

**517.32 Branches Requiring Automatic Connection.****(A) Life Safety and Critical Branch Used in a Type 1 EES.**

Those functions of patient care depending on lighting or appliances that are connected to the essential electrical system shall be divided into the life safety branch and the critical branch, as described in 517.33 and 517.34.

**(B) Life Safety and Critical Branch Used in a Type 2 EES.**

The life safety and critical branches shall be installed and connected to the alternate power source specified in 517.41(A) and (B) so that all functions specified herein for the life safety and critical branches are automatically restored to operation within 10 seconds after interruption of the normal source. [99:6.7.5.3.1]

**517.33 Life Safety Branch.**

The life safety branch shall be limited to circuits essential to life safety. [99:6.7.5.1.2.3]

No functions other than those listed in 517.33(A) through (H) shall be connected to the life safety branch. The life safety branch shall supply power as follows:

**(A) Illumination of Means of Egress.**

Illumination of means of egress such as lighting required for corridors, passageways, stairways, and landings at exit doors, and all necessary ways of approach to exits. Switching arrangements to transfer patient corridor lighting in hospitals from general illumination circuits to night illumination circuits shall be permitted, if only one of two circuits can be selected and both circuits cannot be extinguished at the same time.

Informational Note: See NFPA 101-2021, *Life Safety Code*, Sections 7.8 and 7.9.

**(B) Exit Signs.**

Exit signs and exit directional signs.

Informational Note: See NFPA 101-2021, *Life Safety Code*, Section 7.10.

**(C) Alarm and Alerting Systems.**

Alarm and alerting systems including the following:

- (1) Fire alarm systems
- (2) Alarm and alerting systems (other than fire alarm systems) shall be connected to the life safety branch or critical branch. [99:6.7.5.1.2.5]
- (3) Alarms for systems used for the piping of nonflammable medical gases
- (4) Mechanical, control, and other accessories required for effective life safety systems operation shall be permitted to be connected to the life safety branch.

**(D) Communications Systems.**

Hospital communications systems, where used for issuing instructions during emergency conditions. [99:6.7.5.1.2.4(3)]

**(E) Generator Set Locations.**

Generator set locations as follows:

- (1) Task illumination
- (2) Battery charger for emergency battery-powered lighting unit(s)
- (3) Select receptacles at the generator set location and essential electrical system transfer switch locations

[99:6.7.5.1.2.4(4)]

**(F) Generator Set Accessories.**

Loads dedicated to a specific generator, including the fuel transfer pump(s), ventilation fans, electrically operated louvers, controls, cooling system, and other generator accessories essential for generator operation, shall be connected to the life safety branch or to the output terminals of the generator with overcurrent protective devices. [99:6.7.5.1.2.6]

**(G) Elevators.**

Elevator cab lighting, control, communications, and signal systems. [99:6.7.5.1.2.4(5)]

**(H) Automatic Doors.**

Electrically powered doors used for building egress. [99:6.7.5.1.2.4(6)]

**517.34 Critical Branch.**

**(A) Task Illumination, Fixed Equipment, and Select Receptacles.**

The critical branch shall supply power for task illumination, fixed equipment, select receptacles, and select power circuits serving the following spaces and functions related to patient care:

- (1) Category 1 spaces where deep sedation or general anesthesia is administered, task illumination, select receptacles, and fixed equipment
- (2) Task illumination and select receptacles in the following:
  - a. Patient care spaces, including infant nurseries, selected acute nursing areas, psychiatric bed areas (omit receptacles), and ward treatment rooms
  - b. Medication preparation spaces
  - c. Pharmacy dispensing spaces
  - d. Nurses' stations — unless adequately lighted by corridor luminaires
- (3) Additional specialized patient care task illumination and receptacles, where needed
- (4) Nurse call systems
- (5) Blood, bone, and tissue banks
- (6) Telecommunications entrance facility, telecommunications equipment rooms, and telecommunication rooms and equipment in these rooms
- (7) Task illumination, select receptacles, and select power circuits for the following areas:
  - a. Category 1 or 2 spaces with at least one duplex receptacle per patient bed location, and task illumination as required by the governing body of the health care facility
  - b. Angiographic labs
  - c. Cardiac catheterization labs
  - d. Coronary care units
  - e. Hemodialysis rooms or areas
  - f. Emergency room treatment areas (select)
  - g. Human physiology labs
  - h. Intensive care units
  - i. Postoperative recovery rooms (select)
- (8) Clinical IT-network equipment
- (9) Wireless phone and paging equipment for clinical staff communications
- (10) Additional task illumination, receptacles, and select power circuits needed for effective facility operation, including single-phase fractional horsepower motors, which are permitted to be connected to the critical branch

[99:6.7.5.1.3.2]

**(B) Switching.**

It shall be permitted to control task illumination on the critical branch.

**(C) Subdivision of the Critical Branch.**

The critical branch shall be permitted to be subdivided into two or more branches.

[99:6.7.5.1.3.1]

Informational Note: It is important to analyze the consequences of supplying an area with only critical branch power when failure occurs between the area and the transfer switch. Some proportion of normal and critical power or critical power from separate transfer switches might be appropriate.

**517.35 Equipment Branch Connection to Alternate Power Source.**

The equipment branch shall be installed and connected to the alternate power source such that the equipment described in 517.35(A) is automatically restored to operation at appropriate time-lag intervals following the energizing of the life safety and critical branches.

[99:6.7.5.1.4.2(A)]

The arrangement of the connection to the alternate power source shall also provide for the subsequent connection of equipment described in 517.35(B). [99:6.7.5.1.4.2(B)]

*Exception: For essential electrical systems under 150 kVA, deletion of the time-lag intervals feature for delayed automatic connection to the equipment system shall be permitted.*

**(A) Equipment for Delayed Automatic Connection.**

The following equipment shall be permitted to be arranged for delayed automatic connection to the alternate power source:

- (1) Central suction systems serving medical and surgical functions, including controls, with such suction systems permitted to be placed on the critical branch
- (2) Sump pumps and other equipment required to operate for the safety of major apparatus, including associated control systems and alarms
- (3) Compressed air systems serving medical and surgical functions, including controls with such air systems permitted to be placed on the critical branch
- (4) Smoke control and stair pressurization systems
- (5) Kitchen hood supply or exhaust systems, or both, if required to operate during a fire in or under the hood
- (6) Supply, return, and exhaust ventilating systems for the following:
  - a. Airborne infectious/isolation rooms
  - b. Protective environment rooms
  - c. Exhaust fans for laboratory fume hoods
  - d. Nuclear medicine areas where radioactive material is used
  - e. Ethylene oxide evacuation
  - f. Anesthetic evacuation

[99:6.7.5.1.4.3(A)]

Where delayed automatic connection is not appropriate, the ventilation systems specified in 517.35(A)(6) shall be permitted to be placed on the critical branch. [99:6.7.5.1.4.3(B)]

- (7) Supply, return, and exhaust ventilating systems for operating and delivery rooms
- (8) Supply, return, exhaust ventilating systems and/or air-conditioning systems serving telephone equipment rooms and closets and data equipment rooms and closets

*Exception: Sequential delayed automatic connection to the alternate power source to prevent overloading the generator shall be permitted where engineering studies indicate it is necessary.*

**(B) Equipment for Delayed Automatic or Manual Connection.**

The following equipment shall be permitted to be arranged for either delayed automatic or manual connection to the alternate power source:

- (1) Heating equipment to provide heating for operating, delivery, labor, recovery, intensive care, coronary care, nurseries, infection/isolation rooms, emergency treatment spaces, and general patient rooms and pressure maintenance (jockey or make-up) pump(s) for water-based fire protection systems

*Exception: Heating of general patient rooms and infection/isolation rooms during disruption of the normal source shall not be required under any of the following conditions:*

- (1) *The outside design temperature is higher than  $-6.7^{\circ}\text{C}$  ( $20^{\circ}\text{F}$ ).*
- (2) *The outside design temperature is lower than  $-6.7^{\circ}\text{C}$  ( $20^{\circ}\text{F}$ ), and where a selected room(s) is provided for the needs of all confined patients, only such room(s) need be heated.*
- (3) *The facility is served by a dual source of normal power.*

Informational Note No. 1: The design temperature is based on the 97.5 percent design value as shown in Chapter 24 of the ASHRAE *Handbook of Fundamentals* (2013).

Informational Note No. 2: See 517.30(C) for a description of a dual source of normal power.

- (2) An elevator(s) selected to provide service to patient, surgical, obstetrical, and ground floors during interruption of normal power. In instances where interruption of normal power would result in other elevators stopping between floors, throw-over facilities shall be provided to allow the temporary operation of any elevator for the release of patients or other persons who may be confined between floors.
- (3) Hyperbaric facilities.
- (4) Hypobaric facilities.
- (5) Automatically operated doors.
- (6) Minimal electrically heated autoclaving equipment shall be permitted to be arranged for either automatic or manual connection to the alternate source.
- (7) Controls for equipment listed in 517.35.
- (8) Other selected equipment shall be permitted to be served by the equipment system.  
[99:6.7.5.1.4.4]

**517.40 Type 2 Essential Electrical Systems.**

Informational Note No. 1: Nursing homes and other limited care facilities can contain Category 1 and/or Category 2 patient care spaces, depending on the design and type of care administered in the facility. For Category 1 spaces, see 517.29 through 517.35. For Category 2 spaces not served by Type 1 essential electrical systems, see 517.40 through 517.44.

Informational Note No. 2: Type 2 essential electrical systems are comprised of two separate branches capable of supplying a limited amount of lighting and power service that is considered essential for the protection of life and safety and effective operation of the institution during the time normal electrical service is interrupted for any reason. These two separate branches are the life safety and equipment branches. The number of transfer switches to be used should be based upon reliability, design, and load considerations. Each branch of the essential electrical system should have one or more transfer switches. One transfer switch should be permitted to serve one or more branches in a facility with a maximum demand on the essential electrical system of 150 kVA (120 kW). [99:A.6.7.6.2.1]



**(A) Applicability.**

The requirements of 517.40(C) through 517.44 shall apply to Category 2 spaces.

*Exception: The requirements of 517.40(C) through 517.44 shall not apply to freestanding buildings used as nursing homes and limited care facilities if the following apply:*

- (1) *Admitting and discharge policies are maintained that preclude the provision of care for any patient or resident who might need to be sustained by electrical life-support equipment.*
- (2) *No surgical treatment requiring general anesthesia is offered.*
- (3) *An automatic battery-operated system(s) or equipment shall be effective for at least 1½ hours and is otherwise in accordance with 700.12 and that shall be capable of supplying lighting for exit lights, exit corridors, stairways, nursing stations, medical preparation areas, boiler rooms, and communications areas. This system shall also supply power to operate all alarm systems.*

Informational Note: See NFPA 101-2021, *Life Safety Code*.

**(B) Category 1 Spaces in Inpatient Hospital Care Facilities.**

For those nursing homes and limited care facilities that admit patients who need to be sustained by electrical life-support equipment, the essential electrical system from the source to the portion of the facility where such patients are treated shall comply with the requirements of 517.29 through 517.35.

**(C) Facilities Contiguous or Located on the Same Site with Hospitals.**

Nursing homes and limited care facilities that are contiguous or located on the same site with a hospital shall be permitted to have their essential electrical systems supplied by the hospital.

**517.41 Required Power Sources.****(A) Independent Power Sources.**

Essential electrical systems (EES) shall have two or more independent sources (or sets of sources). One on-site source (or sets of sources) shall be sized to supply the entire EES. The other independent source (or sets of sources) shall be sized to supply the entire EES and shall be permitted to be located on-site or off-site. Additional sources other than the first two independent sources shall be permitted to be sized to supply the intended load.

Informational Note: An example of a set of sources may be several generators that combined serve the entire EES.

**(B) Location of EES Components.**

EES components shall be located to minimize interruptions caused by natural forces common to the area (e.g., storms, floods, earthquakes, or hazards created by adjoining structures or activities). [99:6.2.4.1]

Installations of electrical services shall be located to reduce possible interruption of normal electrical services resulting from similar causes as well as possible disruption of normal electrical service due to internal wiring and equipment failures. [99:6.2.4.2]

Feeders shall be located to provide physical separation of the feeders of the alternate source and from the feeders of the normal electrical source to prevent possible simultaneous interruption. [99:6.2.4.3]

**517.42 Essential Electrical Systems for Nursing Homes and Limited Care Facilities.**

**(A) General.**

The [Type 2] essential electrical system shall be divided into the following two branches:

- (1) Life safety branch
- (2) Equipment branch

[99:6.7.6.2.1.2]

The division between the branches shall occur at transfer switches where more than one transfer switch is required. [99:6.7.2.2.1]

Informational Note No. 1: Type 2 essential electrical systems are comprised of two separate branches capable of supplying a limited amount of lighting and power service that is considered essential for the protection of life and safety and effective operation of the institution during the time normal electrical service is interrupted for any reason. These two separate branches are the life safety and equipment branches.

[99:A.6.7.6.2.1]

Informational Note No. 2: The number of transfer switches to be used should be based upon reliability, design, and load considerations. Each branch of the essential electrical system should have one or more transfer switches. One transfer switch should be permitted to serve one or more branches in a facility with a maximum demand on the essential electrical system of 150 kVA (120 kW). [99:A.6.7.6.2.1]

Informational Note No. 3: See NFPA 99-2021, *Health Care Facilities Code*, 6.7.2.2, for more information.

**(B) Transfer Switches.**

The number of transfer switches to be used shall be based upon reliability, design, and load considerations. [99:6.7.2.2.3]

Transfer switches shall be in accordance with one of the following:

- (1) Each branch of the essential electrical system shall have one or more transfer switches. [99:6.7.2.2.3.1]
- (2) One transfer switch shall be permitted to serve one or more branches in a facility with a continuous load on the switch of 150 kVA (120 kW) or less. [99:6.7.2.2.3.2]

Informational Note No. 1: See NFPA 99-2021, *Health Care Facilities Code*, 6.7.2.2.4, 6.7.2.2.5, 6.7.2.2.5.15, and 6.7.2.2.7 for more information on transfer switches.

Informational Note No. 2: See Informational Note Figure 517.42(B)(1).

Informational Note No. 3: See Informational Note Figure 517.42(B)(2).

**Figure Informational Note Figure 517.42(B)(1) Type 2 Essential Electrical Systems (Nursing Home and Limited Health Care Facilities) — Minimum Requirement (Greater Than 150 kVA) for Transfer Switch Arrangement.**

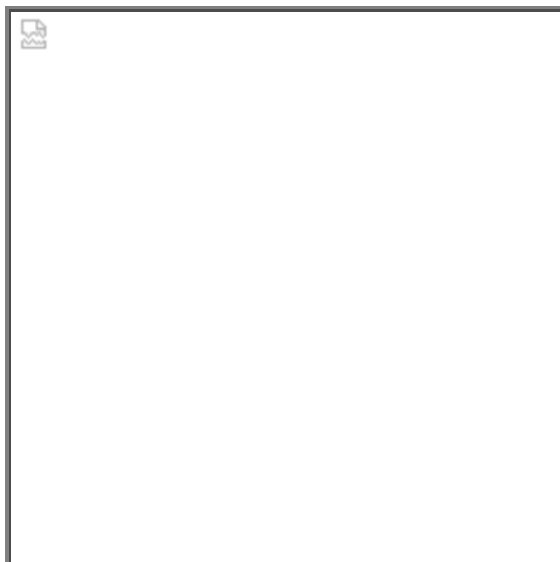

**Figure Informational Note Figure 517.42(B)(2) Type 2 Essential Electrical Systems (Nursing Home and Limited Health Care Facilities) — Minimum Requirement (150 kVA or Less) for Transfer Switch Arrangement.**

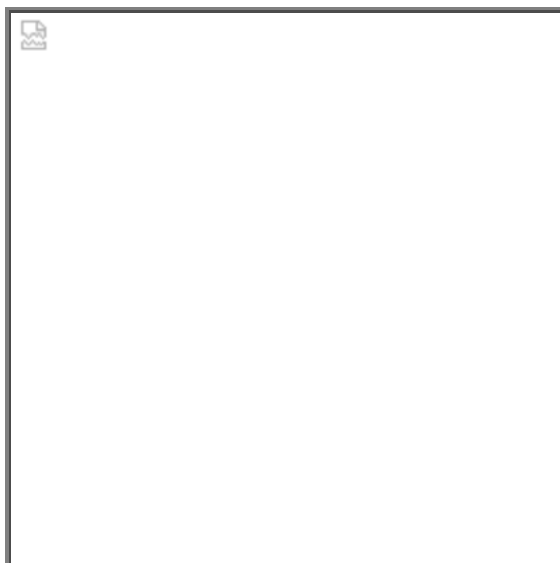

**(C) Capacity of System.**

The essential electrical system shall have capacity to meet the demand for the operation of all functions and equipment to be served by each branch at one time.

**(D) Separation from Other Circuits.**

The life safety branch and equipment branch shall be kept entirely independent of all other wiring and equipment. [99:6.7.6.3.1]

These circuits shall not enter the same raceways, boxes, or cabinets with other wiring except as follows:

- (1) In transfer switches
- (2) In exit or emergency luminaires supplied from two sources
- (3) In a common junction box attached to exit or emergency luminaires supplied from two sources

**(E) Receptacle Identification.**

The electrical receptacles or the cover plates for the electrical receptacles supplied from the life safety or equipment branches shall have a distinctive color or marking so as to be readily identifiable. [99:6.7.6.3.2]

Informational Note: If color is used to identify these receptacles, the same color should be used throughout the facility. [99:A.6.7.6.3.2]

**517.43 Automatic Connection to Life Safety and Equipment Branch.**

The life safety and equipment branches shall be installed and connected to the alternate source of power specified in 517.41 so that all functions specified herein for the life safety and equipment branches are automatically restored to operation within 10 seconds after interruption of the normal source. [99:6.7.6.4.1]

No functions other than those listed in 517.43(A) through (G) shall be connected to the life safety branch. [99:6.7.6.2.1.5(D)]

The life safety branch shall supply power as follows:

**(A) Illumination of Means of Egress.**

Illumination of means of egress as is necessary for corridors, passageways, stairways, landings, and exit doors and all ways of approach to exits. Switching arrangement to transfer patient corridor lighting from general illumination circuits shall be permitted if only one of two circuits can be selected and both circuits cannot be extinguished at the same time.

Informational Note: See NFPA 101-2021, *Life Safety Code*, Sections 7.8 and 7.9.

**(B) Exit Signs.**

Exit signs and exit directional signs.

Informational Note: See NFPA 101-2021, *Life Safety Code*, Section 7.10.

**(C) Alarm and Alerting Systems.**

Alarm and alerting systems, including the following:

- (1) Fire alarms

Informational Note No. 1: See NFPA 101-2021, *Life Safety Code*, Sections 9.6 and 18.3.4.

- (2) Alarms required for systems used for the piping of nonflammable medical gases

Informational Note No. 2: See NFPA 99-2021, *Health Care Facilities Code*, 6.7.5.1.2.5.

**(D) Communications Systems.**

Communications systems, where used for issuing instructions during emergency conditions. [99:6.7.5.1.2.4(3)]

**(E) Generator Set Location.**

Task illumination and select receptacles at the generator set location and essential electrical system transfer switch locations.

**(F) Elevators.**

Elevator cab lighting, control, communications, and signal systems. [99:6.7.5.1.2.4(5)]

**(G) AC Equipment for Nondelayed Automatic Connection.**

Generator accessories, including, but not limited to, the transfer fuel pump, electrically operated louvers, and other generator accessories essential for generator operation shall be arranged for automatic connection to the alternate power source. [99:6.7.6.2.1.6(C)]

**517.44 Connection to Equipment Branch.**

The equipment branch shall be installed and connected to the alternate power source such that equipment described in 517.35(A)(6) is automatically restored to operation at appropriate time-lag intervals following the energizing of the life safety and critical branches. [99:6.7.5.1.4.2(A)]

The equipment branch arrangement shall also provide for the additional connection of equipment listed in 517.44(B).

*Exception: For essential electrical systems under 150 kVA, deletion of the time-lag intervals feature for delayed automatic connection to the equipment branch shall be permitted.*

**(A) Delayed Automatic Connections to Equipment Branch.**

The following equipment shall be permitted to be connected to the equipment branch and shall be arranged for delayed automatic connection to the alternate power source:

- (1) Task illumination and select receptacles in the following: [99:6.7.6.2.1.6(D)(1)]
  - a. Patient care spaces [99:6.7.6.2.1.6(D)(1)(a)]
  - b. Medication preparation spaces [99:6.7.6.2.1.6(D)(1)(b)]
  - c. Pharmacy dispensing space [99:6.7.6.2.1.6(D)(1)(c)]
  - d. Nurses' stations — unless adequately lighted by corridor luminaires [99:6.7.6.2.1.6(D)(1)(d)]
- (2) Supply, return, and exhaust ventilating systems for airborne infectious isolation rooms [99:6.7.6.2.1.6(D)(2)]
- (3) Sump pumps and other equipment required to operate for the safety of major apparatus and associated control systems and alarms [99:6.7.6.2.1.6(D)(3)]
- (4) Smoke control and stair pressurization systems [99:6.7.6.2.1.6(D)(4)]
- (5) Kitchen hood supply or exhaust systems, or both, if required to operate during a fire in or under the hood [99:6.7.6.2.1.6(D)(5)]
- (6) Nurse call systems [99:6.7.6.2.1.6(D)(6)]

**(B) Delayed-Automatic or Manual Connection to the Equipment Branch.**

The equipment specified in 517.44(B)(1) through (B)(4) shall be permitted to be connected to the equipment branch and shall be arranged for either delayed-automatic or manual connection to the alternate power source.

**(1) Heating Equipment to Provide Heating for General Patient Rooms.**

Heating of general patient rooms during disruption of the normal source shall not be required under any of the following conditions:

- (1) The outside design temperature is higher than  $-6.7^{\circ}\text{C}$  ( $20^{\circ}\text{F}$ ).
- (2) The outside design temperature is lower than  $-6.7^{\circ}\text{C}$  ( $20^{\circ}\text{F}$ ) and, where a selected room(s) is provided for the needs of all confined patients, then only such room(s) need be heated.
- (3) The facility is served by a dual source of normal power as described in 517.30(C), Informational Note.

Informational Note: The outside design temperature is based on the 97.5 percent design values, as shown in Chapter 24 of the *ASHRAE Handbook of Fundamentals* (2013).

**(2) Elevator Service.**

In instances where interruptions of power would result in elevators stopping between floors, throw-over facilities shall be provided to allow the temporary operation of any elevator for the release of passengers.

**(3) Optional Connections to the Equipment Branch.**

Additional illumination, receptacles, and equipment shall be permitted to be connected only to the equipment branch.

**(4) Multiple Systems.**

Where one switch serves multiple systems as permitted in 517.43, transfer for all loads shall be nondelayed automatic.

[99:6.7.6.2.1.6(E)]

Informational Note: See 517.43(G) for elevator cab lighting, control, and signal system requirements. [99:A.6.7.6.2.1.6(E)(2)]

**517.45 Essential Electrical Systems for Other Health Care Facilities.****(A) Essential Electrical Distribution.**

If required by the governing body, the essential electrical distribution system for Category 3 patient care spaces shall be comprised of an alternate power system capable of supplying a limited amount of lighting and power service for the orderly cessation of procedures during a time normal electrical service is interrupted.

Informational Note: See NFPA 99-2021, *Health Care Facilities Code*.

**(B) Electrical Life Support Equipment.**

Where electrical life support equipment is required, the essential electrical distribution system shall be as described in 517.29 through 517.30.

**(C) Category 1 Patient Care Spaces.**

Where Category 1 patient care spaces are present, the essential electrical distribution system shall be in accordance with 517.29 through 517.30.

**(D) Category 2 Patient Care Spaces.**

Where Category 2 patient care spaces are present, the essential electrical distribution system shall be in accordance with 517.40 through 517.45.

**(E) Power Systems.**

If required, alternate power sources acceptable to the governing body shall comply with the requirements of NFPA 99-2021, *Health Care Facilities Code*.

#### **Part IV. Inhalation Anesthetizing Locations**

Informational Note: See NFPA 99-2021, *Health Care Facilities Code*, for further information regarding safeguards for anesthetizing locations.

##### **517.60 Anesthetizing Location Classification.**

Informational Note: See 517.20 if either of the anesthetizing locations in 517.60(A) or 517.60(B) is designated a wet procedure location.

##### **(A) Hazardous (Classified) Location.**

###### **(1) Use Location.**

In a location where flammable anesthetics are employed, the entire area shall be considered to be a Class I, Division 1 location that extends upward to a level 1.52 m (5 ft) above the floor. The remaining volume up to the structural ceiling is considered to be above a hazardous (classified) location.

###### **(2) Storage Location.**

Any room or location in which flammable anesthetics or volatile flammable disinfecting agents are stored shall be considered to be a Class I, Division 1 location from floor to ceiling.

##### **(B) Unclassified Location.**

Any inhalation anesthetizing location designated for the exclusive use of nonflammable anesthetizing agents shall be considered to be an unclassified location.

##### **517.61 Wiring and Equipment.**

##### **(A) Within Hazardous (Classified) Anesthetizing Locations.**

###### **(1) Isolation.**

Except as permitted in 517.160, each power circuit within, or partially within, a flammable anesthetizing location as referred to in 517.60 shall be isolated from any distribution system by the use of an isolated power system.

###### **(2) Design and Installation.**

Where an isolated power system is utilized, the isolated power equipment shall be listed as isolated power equipment, and the isolated power system shall be designed and installed in accordance with 517.160.

###### **(3) Equipment Operating at More Than 10 Volts.**

In hazardous (classified) locations referred to in 517.60, all fixed wiring and equipment and all portable equipment, including lamps and other utilization equipment, operating at more than 10 volts between conductors shall comply with the requirements of 501.1 through 501.25, and 501.100 through 501.150, and 501.30(A) and (B) for Class I, Division 1 locations. All such equipment shall be specifically approved for the hazardous atmospheres involved.

###### **(4) Extent of Location.**

Where a box, fitting, or enclosure is partially, but not entirely, within a hazardous (classified) location(s), the hazardous (classified) location(s) shall be considered to be extended to include the entire box, fitting, or enclosure.

###### **(5) Receptacles and Attachment Plugs.**

Receptacles and attachment plugs in a hazardous (classified) location(s) shall be listed for use in Class I, Group C hazardous (classified) locations and shall have provision for the connection of an equipment grounding conductor.

###### **(6) Flexible Cord Type.**

Flexible cords used in hazardous (classified) locations for connection to portable utilization equipment, including lamps operating at more than 8 volts between conductors, shall be of a type approved for extra-hard usage in accordance with Table 400.4 and shall include an additional equipment grounding conductor.

**(7) Flexible Cord Storage.**

A storage device for the flexible cord shall be provided and shall not subject the cord to bending at a radius of less than 75 mm (3 in.).

**(B) Above Hazardous (Classified) Anesthetizing Locations.****(1) Wiring Methods.**

Wiring above a hazardous (classified) location referred to in 517.60 shall be installed in rigid metal conduit, electrical metallic tubing, intermediate metal conduit, Type MI cable, or Type MC cable that employs a continuous, gas/vaportight metal sheath.

**(2) Equipment Enclosure.**

Installed equipment that may produce arcs, sparks, or particles of hot metal, such as lamps and lampholders for fixed lighting, cutouts, switches, generators, motors, or other equipment having make-and-break or sliding contacts, shall be of the totally enclosed type or be constructed so as to prevent escape of sparks or hot metal particles.

*Exception: Wall-mounted receptacles installed above the hazardous (classified) location in flammable anesthetizing locations shall not be required to be totally enclosed or have openings guarded or screened to prevent dispersion of particles.*

**(3) Luminaires.**

Surgical and other luminaires shall conform to 501.130(B).

*Exception No. 1: The surface temperature limitations set forth in 501.130(B)(1) shall not apply.*

*Exception No. 2: Integral or pendant switches that are located above and cannot be lowered into the hazardous (classified) location(s) shall not be required to be explosionproof.*

**(4) Seals.**

Listed seals shall be provided in conformance with 501.15, and 501.15(A)(4) shall apply to horizontal as well as to vertical boundaries of the defined hazardous (classified) locations.

**(5) Receptacles and Attachment Plugs.**

Receptacles and attachment plugs located above hazardous (classified) anesthetizing locations shall be listed for hospital use for services of prescribed voltage, frequency, rating, and number of conductors with provision for the connection of the equipment grounding conductor. This requirement shall apply to attachment plugs and receptacles of the 2-pole, 3-wire grounding type for single-phase, 120-volt, nominal, ac service.

**(6) 250-Volt Receptacles and Attachment Plugs Rated 50 and 60 Amperes.**

Receptacles and attachment plugs rated 250 volts, for connection of 50-ampere and 60-ampere ac medical equipment for use above hazardous (classified) locations, shall be arranged so that the 60-ampere receptacle will accept either the 50-ampere or the 60-ampere plug. Fifty-ampere receptacles shall be designed so as not to accept the 60-ampere attachment plug. The attachment plugs shall be of the 2-pole, 3-wire design with a third contact connecting to the insulated (green or green with yellow stripe) equipment grounding conductor of the electrical system.

**(C) Unclassified Anesthetizing Locations.****(1) Wiring Methods.**

Wiring serving unclassified locations, as defined in 517.60, shall be installed in a metal raceway system or cable assembly. The metal raceway system or cable armor or sheath assembly shall qualify as an equipment grounding conductor in accordance with 250.118. Type MC and Type MI cable shall have an outer metal armor, sheath, or sheath assembly that is identified as an equipment grounding conductor.

*Exception: Pendant receptacle installations that employ listed Type SJO or equivalent hard usage or extra-hard usage, flexible cords suspended not less than 1.8 m (6 ft) from the floor shall not be required to be installed in a metal raceway or cable assembly.*



**(2) Receptacles and Attachment Plugs.**

Receptacles and attachment plugs installed and used in unclassified locations shall be listed "hospital grade" for services of prescribed voltage, frequency, rating, and number of conductors with provision for connection of the equipment grounding conductor. This requirement shall apply to 2-pole, 3-wire grounding type for single-phase, 120-, 208-, or 240-volt, nominal, ac service.

**(3) 250-Volt Receptacles and Attachment Plugs Rated 50 Amperes and 60 Amperes.**

Receptacles and attachment plugs rated 250 volts, for connection of 50-ampere and 60-ampere ac medical equipment for use in unclassified locations, shall be arranged so that the 60-ampere receptacle will accept either the 50-ampere or the 60-ampere plug. Fifty-ampere receptacles shall be designed so as not to accept the 60-ampere attachment plug. The attachment plugs shall be of the 2-pole, 3-wire design with a third contact connecting to the insulated (green or green with yellow stripe) equipment grounding conductor of the electrical system.

**517.62 Grounding.**

In any anesthetizing area, all metal raceways and metal-sheathed cables and all normally non-current-carrying conductive portions of fixed electrical equipment shall be connected to an equipment grounding conductor. Grounding and bonding in Class I locations shall comply with 501.30.

*Exception: Equipment operating at not more than 10 volts between conductors shall not be required to be connected to an equipment grounding conductor.*

**517.63 Grounded Power Systems in Anesthetizing Locations.****(A) Battery-Powered Lighting Units.**

One or more battery-powered lighting units shall be provided and shall be permitted to be wired to the critical lighting circuit in the area and connected ahead of any local switches.

**(B) Branch-Circuit Wiring.**

Branch circuits supplying only listed, fixed, therapeutic and diagnostic equipment, permanently installed above the hazardous (classified) location and in unclassified locations, shall be permitted to be supplied from a normal grounded service, single- or three-phase system, provided the following apply:

- (1) Wiring for grounded and isolated circuits does not occupy the same raceway or cable.
- (2) All conductive surfaces of the equipment are connected to an equipment grounding conductor.
- (3) Equipment (except enclosed X-ray tubes and the leads to the tubes) is located at least 2.5 m (8 ft) above the floor or outside the anesthetizing location.
- (4) Switches for the grounded branch circuit are located outside the hazardous (classified) location.

*Exception: Sections 517.63(B)(3) and (B)(4) shall not apply in unclassified locations.*

**(C) Fixed Lighting Branch Circuits.**

Branch circuits supplying only fixed lighting shall be permitted to be supplied by a normal grounded service, provided the following apply:

- (1) Such luminaires are located at least 2.5 m (8 ft) above the floor.
- (2) All conductive surfaces of luminaires are connected to an equipment grounding conductor.
- (3) Wiring for circuits supplying power to luminaires does not occupy the same raceway or cable for circuits supplying isolated power.
- (4) Switches are wall-mounted and located above hazardous (classified) locations.

*Exception: Sections 517.63(C)(1) and (C)(4) shall not apply in unclassified locations.*

**(D) Remote-Control Stations.**

Wall-mounted remote-control stations for remote-control switches operating at 24 volts or less shall be permitted to be installed in any anesthetizing location.

**(E) Location of Isolated Power Systems.**

Where an isolated power system is utilized, the isolated power equipment shall be listed as isolated power equipment. Isolated power system equipment and its supply circuit shall be permitted to be located in an anesthetizing location, provided it is installed above a hazardous (classified) location or in an unclassified location.

**(F) Circuits in Anesthetizing Locations.**

Except as permitted above, each power circuit within, or partially within, a flammable anesthetizing location as referred to in 517.60 shall be isolated from any distribution system supplying other-than-anesthetizing locations.

**517.64 Low-Voltage Equipment and Instruments.****(A) Equipment Requirements.**

Low-voltage equipment that is frequently in contact with the bodies of persons or has exposed current-carrying elements shall comply with one of the following:

- (1) Operate on an electrical potential of 10 volts or less
- (2) Be approved as intrinsically safe or double-insulated equipment
- (3) Be moisture resistant

**(B) Power Supplies.**

Power shall be supplied to low-voltage equipment from one of the following:

- (1) An individual portable isolating transformer (autotransformers shall not be used) connected to an isolated power circuit receptacle by means of an appropriate cord and attachment plug
- (2) A common low-voltage isolating transformer installed in an unclassified location
- (3) Individual dry-cell batteries
- (4) Common batteries made up of storage cells located in an unclassified location

**(C) Isolated Circuits.**

Isolating-type transformers for supplying low-voltage circuits shall have both of the following:

- (1) Approved means for insulating the secondary circuit from the primary circuit
- (2) The core and case connected to an equipment grounding conductor

**(D) Controls.**

Resistance or impedance devices shall be permitted to control low-voltage equipment but shall not be used to limit the maximum available voltage to the equipment.

**(E) Battery-Powered Appliances.**

Battery-powered appliances shall not be capable of being charged while in operation unless their charging circuitry incorporates an integral isolating-type transformer.

**(F) Receptacles or Attachment Plugs.**

Any receptacle or attachment plug used on low-voltage circuits shall be of a type that does not permit interchangeable connection with circuits of higher voltage.

Informational Note: Any interruption of the circuit, even circuits as low as 10 volts, either by any switch or loose or defective connections anywhere in the circuit, may produce a spark that is sufficient to ignite flammable anesthetic agents.

**Part V. Diagnostic Imaging and Treatment Equipment**

**517.70** Applicability.

Nothing in this part shall be construed as specifying safeguards against possible radiation or magnetic fields.

Informational Note No. 1: Radiation safety and performance requirements of several classes of X-ray equipment are regulated under Public Law 90-602 and are enforced by the Department of Health and Human Services.

Informational Note No. 2: Information on radiation protection by the National Council on Radiation Protection and Measurements is published as *Reports of the National Council on Radiation Protection and Measurement*. These reports are obtainable from NCRP Publications, P.O. Box 30175, Washington, DC 20014.

Informational Note No. 3: Examples of diagnostic imaging equipment can include, but are not limited to, the following:

- (1) General radiographic (X-ray) equipment (mobile and fixed)
- (2) General fluoroscopic equipment (mobile and fixed)
- (3) Interventional equipment (mobile and fixed)
- (4) Bone mineral density equipment
- (5) Dental equipment
- (6) Computerized tomography (CT) equipment
- (7) Positron emission tomography (PET) equipment
- (8) Nuclear medicine equipment
- (9) Mammography equipment
- (10) Magnetic resonance (MR) equipment
- (11) Diagnostic ultrasound equipment
- (12) Electrocardiogram equipment

Informational Note No. 4: Examples of treatment equipment can include, but are not limited to, the following:

- (1) Linear accelerators
- (2) Gamma knife
- (3) Cyber knife
- (4) Proton therapy
- (5) Tomotherapy

**517.71** Connection to Supply Circuit.**(A)** Fixed and Stationary Diagnostic Imaging and Treatment Equipment.

Fixed and stationary diagnostic imaging and treatment equipment shall be connected to the power supply by means of a wiring method complying with applicable requirements of Chapters 1 through 4 of this *Code*, as modified by this article.

*Exception: Equipment properly supplied by a branch circuit rated at not over 30 amperes shall be permitted to be supplied through a suitable attachment plug and hard-service cable or cord.*

**(B)** Portable, Mobile, and Transportable Diagnostic Imaging and Treatment Equipment.

Individual branch circuits shall not be required for portable, mobile, and transportable medical diagnostic imaging and treatment equipment requiring a capacity of not over 60 amperes.

**(C) Over 1000-Volt Supply.**

Circuits and equipment operated on a supply circuit of over 1000 volts shall comply with Parts I through IV of Article 495.

**517.72 Disconnecting Means.****(A) Capacity.**

A disconnecting means rated for at least 50 percent of the input required for the momentary rating or 100 percent of the input required for the long-time rating of the diagnostic imaging and treatment equipment, whichever is greater, shall be provided in the supply circuit.

**(B) Location.**

The disconnecting means shall be operable from a location readily accessible from the control location.

**(C) Portable, Mobile, and Transportable Diagnostic Imaging and Treatment Equipment.**

For equipment connected to a 120-volt branch circuit of 30 amperes or less, a grounding-type attachment plug and receptacle of proper rating shall be permitted to serve as a disconnecting means.

**517.73 Rating of Supply Conductors and Overcurrent Protection.****(A) Branch Circuits.**

The ampacity of supply branch-circuit conductors and the current rating of overcurrent protective devices shall not be less than 50 percent of the momentary rating or 100 percent of the long-time rating, whichever is greater.

**(B) Feeders.**

The ampacity of supply feeders and the current rating of overcurrent protective devices supplying two or more branch circuits supplying diagnostic imaging and treatment equipment shall not be less than 50 percent of the momentary demand rating of the largest unit, plus 25 percent of the momentary demand rating of the next largest unit, plus 10 percent of the momentary demand rating of each additional unit.

Informational Note No. 1: The minimum conductor size for branch and feeder circuits is also governed by voltage regulation requirements. For a specific installation, the manufacturer usually specifies minimum distribution transformer and conductor sizes, rating of disconnecting means, and overcurrent protection.

Informational Note No. 2: The ampacity of the branch-circuit conductors and the ratings of disconnecting means and overcurrent protection for diagnostic imaging and treatment equipment are usually designated by the manufacturer for the specific installation.

**517.74 Control Circuit Conductors.****(A) Number of Conductors in Raceway.**

The number of control circuit conductors installed in a raceway shall be determined in accordance with 300.17.

**(B) Minimum Size of Conductors.**

Size 18 AWG or 16 AWG fixture wires in accordance with 724.49 and flexible cords shall be permitted for the control and operating circuits of diagnostic imaging and treatment equipment and auxiliary equipment where protected by not larger than 20-ampere overcurrent devices.

**517.76 Transformers and Capacitors.**

Transformers and capacitors that are part of diagnostic imaging and treatment equipment shall not be required to comply with Parts I and II of Articles 450 and 460.

Capacitors shall be mounted within enclosures of insulating material or grounded metal.

**517.77** Installation of Cables with Grounded Shields.

Cables with grounded shields shall be permitted to be installed in cable trays or cable troughs along with control and power supply conductors without the need for barriers to separate the wiring.

**517.78** Guarding and Grounding.**(A)** High-Voltage Parts.

All high-voltage parts shall be mounted within grounded enclosures. The connection from the high-voltage equipment to other high-voltage components shall be made with high-voltage shielded cables.

**(B)** Low-Voltage Cables.

Low-voltage cables connecting to oil-filled units that are not completely sealed, such as transformers, condensers, oil coolers, and high-voltage switches, shall have insulation of the oil-resistant type.

**(C)** Non-Current-Carrying Metal Parts.

Non-current-carrying metal parts of diagnostic imaging and treatment equipment (e.g., controls, tables, transformer tanks, shielded cables) shall be connected to an equipment grounding conductor in accordance with Part VII of Article 250, as modified by 517.13(A) and (B).

**Part VI.** Communications, Signaling Systems, Data Systems, Fire Alarm Systems, and Systems Less Than 120 Volts, Nominal**517.80** Patient Care Spaces.

Equivalent insulation and isolation to that required for the electrical distribution systems in patient care areas shall be provided for communications, signaling systems, data system circuits, fire alarm systems, and systems less than 120 volts, nominal.

Class 2 and Class 3 signaling and communications systems, Class 2 circuits that transmit power and data to a powered device, and power-limited fire alarm systems shall not be required to comply with the grounding requirements of 517.13, to comply with the mechanical protection requirements of 517.31(C)(3)(5), or to be enclosed in raceways, unless otherwise specified by Chapters 7 or 8.

Secondary circuits of transformer-powered communications or signaling systems shall not be required to be enclosed in raceways unless otherwise specified by Chapters 7 or 8.

[99:6.7.2.2.7]

Informational Note: See ANSI/NEMA C137.3-2017, *American National Standard for Lighting Systems — Minimum Requirements for Installation of Energy Efficient Power over Ethernet (PoE) Lighting Systems*, for information on installation of cables for PoE lighting systems.

**517.81** Other-Than-Patient-Care Spaces.

In other-than-patient-care spaces, installations shall be in accordance with other parts of this Code.

**517.82** Signal Transmission Between Appliances.**(A)** General.

Permanently installed signal cabling from an appliance in a patient location to remote appliances shall employ a signal transmission system that prevents hazardous grounding interconnection of the appliances.

Informational Note: See 517.13(A) for additional grounding requirements in patient care spaces.

**(B) Common Signal Grounding Wire.**

Common signal grounding wires (i.e., the chassis ground for single-ended transmission) shall be permitted to be used between appliances all located within the patient care vicinity, provided the appliances are served from the same reference grounding point.

**Part VII. Isolated Power Systems****517.160 Isolated Power Systems.****(A) Installations.****(1) Isolated Power Circuits.**

Each isolated power circuit shall be controlled by a switch or circuit breaker that has a disconnecting pole in each isolated circuit conductor to simultaneously disconnect all power. Such isolation shall be accomplished by means of one or more isolation transformers, by means of generator sets, or by means of electrically isolated batteries. Conductors of isolated power circuits shall not be installed in cables, raceways, or other enclosures containing conductors of another system.

**(2) Circuit Characteristics.**

Circuits supplying primaries of isolating transformers shall operate at not more than 600 volts between conductors and shall be provided with proper overcurrent protection. The secondary voltage of such transformers shall not exceed 600 volts between conductors of each circuit. All circuits supplied from such secondaries shall be ungrounded and shall have an approved overcurrent device of proper ratings in each conductor. Circuits supplied directly from batteries or from motor generator sets shall be ungrounded and shall be protected against overcurrent in the same manner as transformer-fed secondary circuits. If an electrostatic shield is present, it shall be connected to the reference grounding point.

**(3) Equipment Location.**

The isolating transformers, motor generator sets, batteries and battery chargers, and associated primary or secondary overcurrent devices shall not be installed in hazardous (classified) locations. The isolated secondary circuit wiring extending into a hazardous anesthetizing location shall be installed in accordance with 501.10.

**(4) Isolation Transformers.**

An isolation transformer shall not serve more than one operating room except as covered in 517.160(A)(4)(a) and (A)(4)(b).

For purposes of this section, anesthetic induction rooms are considered part of the operating room or rooms served by the induction rooms.

(a) *Induction Rooms.* Where an induction room serves more than one operating room, the isolated circuits of the induction room shall be permitted to be supplied from the isolation transformer of any one of the operating rooms served by that induction room.

(b) *Higher Voltages.* Isolation transformers shall be permitted to serve single receptacles in several patient areas where the following apply:

- (1) The receptacles are reserved for supplying power to equipment requiring 150 volts or higher, such as portable X-ray units.
- (2) The receptacles and mating plugs are not interchangeable with the receptacles on the local isolated power system.

**(5) Conductor Identification.**

The isolated circuit conductors shall be identified as follows:

- (1) Isolated Conductor No. 1 — Orange with at least one distinctive colored stripe other than white, green, or gray along the entire length of the conductor
- (2) Isolated Conductor No. 2 — Brown with at least one distinctive colored stripe other than white, green, or gray along the entire length of the conductor

For 3-phase systems, the third conductor shall be identified as yellow with at least one distinctive colored stripe other than white, green, or gray along the entire length of the conductor. Where isolated circuit conductors supply 125-volt, single-phase, 15- and 20-ampere receptacles, the striped orange conductor(s) shall be connected to the terminal(s) on the receptacles that are identified in accordance with 200.10(B) for connection to the grounded circuit conductor.

**(6) Wire-Pulling Compounds.**

Wire-pulling compounds that increase the dielectric constant shall not be used on the secondary conductors of the isolated power supply.

Informational Note No. 1: It is desirable to limit the size of the isolation transformer to 10 kVA or less and to use conductor insulation with low leakage to meet impedance requirements.

Informational Note No. 2: Minimizing the length of branch-circuit conductors and using conductor insulations with a dielectric constant less than 3.5 and insulation resistance constant greater than 6100 megohm-meters (20,000 megohm-feet) at 16°C (60°F) reduces leakage from line to ground, reducing the hazard current.

**(B) Line Isolation Monitor.****(1) Characteristics.**

In addition to the usual control and overcurrent protective devices, each isolated power system shall be provided with a listed continually operating line isolation monitor that indicates total hazard current. The monitor shall be designed such that a green signal lamp, conspicuously visible to persons in each area served by the isolated power system, remains lighted when the system is adequately isolated from ground. An adjacent red signal lamp and an audible warning signal (remote if desired) shall be energized when the total hazard current (consisting of possible resistive and capacitive leakage currents) from either isolated conductor to ground reaches a threshold value of 5 mA under nominal line voltage conditions. The line monitor shall not alarm for a fault hazard of less than 3.7 mA or for a total hazard current of less than 5 mA.

*Exception: A system shall be permitted to be designed to operate at a lower threshold value of total hazard current. A line isolation monitor for such a system shall be permitted to be approved, with the provision that the fault hazard current shall be permitted to be reduced but not to less than 35 percent of the corresponding threshold value of the total hazard current, and the monitor hazard current is to be correspondingly reduced to not more than 50 percent of the alarm threshold value of the total hazard current.*

**(2) Impedance.**

The line isolation monitor shall be designed to have sufficient internal impedance such that, when properly connected to the isolated system, the maximum internal current that can flow through the line isolation monitor, when any point of the isolated system is grounded, shall be 1 mA.

*Exception: The line isolation monitor shall be permitted to be of the low-impedance type such that the current through the line isolation monitor, when any point of the isolated system is grounded, will not exceed twice the alarm threshold value for a period not exceeding 5 milliseconds.*

Informational Note: Reduction of the monitor hazard current, provided this reduction results in an increased "not alarm" threshold value for the fault hazard current, will increase circuit capacity.

**(3) Ammeter.**

An ammeter calibrated in the total hazard current of the system (contribution of the fault hazard current plus monitor hazard current) shall be mounted in a plainly visible place on the line isolation monitor with the “alarm on” zone at approximately the center of the scale.

*Exception: The line isolation monitor shall be permitted to be a composite unit, with a sensing section cabled to a separate display panel section on which the alarm or test functions are located.*

Informational Note: It is desirable to locate the ammeter so that it is conspicuously visible to persons in the anesthetizing location.

## Additional Proposed Changes

<u>File Name</u>	<u>Description</u>	<u>Approved</u>
PC_239_CMP_15.pdf	NEC_PC239	

## Statement of Problem and Substantiation for Public Input

NOTE: This Public Input appeared as “Reject but Hold” in Public Comment No. 239 of the (A2022) Second Draft Report for NFPA 70 and per the Regs. at 4.4.8.3.1.

PI 3333 in the First Draft meeting asked CMP 15 to review the numbering system in the Articles as related

to the Style Manual. This review was never fully vetted by the panel. This second draft proposal is a recommendation to NFPA staff to review the numbering system used in 517 and provide space for insertion of new language without the panel having to make wholesale numbering changes.

2023 NEC 2nd Draft Numbering Changes to Article 517

Part 1. General (Number Ranges 517.1 - 517.9)

Current Number: To Become: New Number:

517.1 No Change

517.4 No Change

517.6 No Change

Part II. Wiring And Protection Number Range 517.10 - 517.39

Current Number: To Become: New Number:

517.10 No Change

517.12 No Change

517.13 No Change

517.14 No Change

517.16 No Change

517.17 517.21

517.18 517.24

517.19 517.25

517.20 517.29

517.21 517.30

517.22 517.35

Part III. Essential Electrical Systems (Number Range 517.40 - 517.69)

Current Number: To Become: New Number:

517.25 517.40

517.26 517.42

517.29 517.43

517.30 517.45

517.31 517.46

517.32 517.47

517.33 517.50

517.34 517.51

517.35 517.52

517.40 517.60



517.41 517.61

517.42 517.62

517.43 517.63

517.44 517.64

517.45 517.65

Part VI. Anesthetizing Location Classification. (Number Range 517.70 - 517.79)

Current Number: To Become: New Number:

517.60 517.70

517.61 517.71

517.62 517.75

517.63 517.76

517.64 517.68

Part V. Diagnostic Imaging and Treatment Equipment. (Number Range 517.80 - 517.99)

Current Number: To Become: New Number:

517.70 517.80

517.71 517.81

517.72 517.82

517.73 517.85

517.74 517.86

517.76 517.90

517.77 517.92

517.78 517.94

Part V. Communications, Signalling Systems, Data Systems, Fire Alarm Systems, and Systems Less Than 120 Volts, Nominal. (Number Range 517.100 - 517.109)

Current Number: To Become: New Number:

517.80 517.100

517.81 517.101

517.82 517.102

Part VI. Isolated Power Systems. (Number Range 517.110 - 517.120)

Current Number: To Become: New Number:

517.160 517.110

## Submitter Information Verification

**Submitter Full Name:** CMP ON NEC-P15

**Organization:** Code-Making Panel 15

**Street Address:**

**City:**

**State:**

**Zip:**

**Submittal Date:** Tue Sep 05 13:47:05 EDT 2023

**Committee:** NEC-P15



## Public Comment No. 239-NFPA 70-2021 [ Article 517 ]

### Article 517 Health Care Facilities

#### Part I. General

##### 517.1 Scope.

This article applies to electrical construction and installation criteria in health care facilities that provide services to human beings.

The requirements in Parts II and III not only apply to single-function buildings but are also intended to be individually applied to their respective forms of occupancy within a multifunction building (e.g., a doctor's examining room located within a limited care facility would be required to meet 517.10).

Informational Note No. 1 : For information concerning performance, maintenance, and testing criteria, refer to the appropriate health care facilities documents.

Informational Note No. 2: Text that is followed by a reference in brackets has been extracted from NFPA 99-2021, *Health Care Facilities Code*, or NFPA 101-2021, *Life Safety Code*. Only editorial changes were made to the extracted text to make it consistent with this *Code*.

##### 517.4 General Installation — Construction Criteria.

The requirements of this article shall specify the installation criteria and wiring methods that minimize electrical hazards by the maintenance of adequately low potential differences only between exposed conductive surfaces that are likely to become energized and could be contacted by a patient.

Informational Note: In a health care facility, it is difficult to prevent the occurrence of a conductive or capacitive path from the patient's body to some grounded object, because that path might be established accidentally or through instrumentation directly connected to the patient. Other electrically conductive surfaces that might make an additional contact with the patient, or instruments that might be connected to the patient, then become possible sources of electric currents that can traverse the patient's body. The hazard is increased as more apparatus is associated with the patient, therefore more intensive precautions are needed. Control of electric shock hazard requires the limitation of electric current that might flow in an electrical circuit involving the patient's body by raising the resistance of the conductive circuit that includes the patient, or by insulating exposed surfaces that might become energized, in addition to reducing the potential difference that can appear between exposed conductive surfaces in the patient care vicinity, or by combinations of these methods. A special problem is presented by the patient with an externalized direct conductive path to the heart muscle. The patient could be electrocuted at current levels so low that additional protection in the design of appliances, insulation of the catheter, and control of medical practice is required.

##### 517.6 Patient Care–Related Electrical Equipment.

The reconditioning requirements of this *Code* shall not apply to patient care–related electrical equipment.

Informational Note No. 1: Patient care–related electrical equipment is differentiated from electrical equipment as described in 110.21(A)(2).

Informational Note No. 2: If patient care–related electrical equipment is relocated, it is expected to be recommissioned or recertified in accordance with the U.S. *Federal Food, Drug, and Cosmetic Act (FDCA)*.

#### Part II. Wiring and Protection

##### 517.10 Applicability.

**(A) Applicability.**

Part II shall apply to patient care space of all health care facilities.

**(B) Not Covered.**

Part II shall not apply to the following:

- (1) Business offices, corridors, waiting rooms, and the like in clinics, medical and dental offices, and outpatient facilities
- (2) Spaces of nursing homes and limited care facilities wired in accordance with Chapters 1 through 4 of this Code where these spaces are used exclusively as patient sleeping rooms

Informational Note No. 1: See 406.12(5) for receptacles located in health care facility business offices, corridors, and waiting rooms that are required to be tamper resistant.

Informational Note No. 2: See 210.12(D) for branch circuits supplying outlets and receptacles located in patient sleeping rooms in nursing homes and limited care facilities that are connected to arc-fault circuit-interrupter circuits.

- (3) Areas used exclusively for any of the following purposes:

- (4) Intramuscular injections (immunizations)
- (5) Psychiatry and psychotherapy
- (6) Alternative medicine
- (7) Optometry
- (8) Pharmacy services not contiguous to health care facilities

Informational Note No. 3: See NFPA 101 -2021, Life Safety Code .

**517.12 Wiring Methods.**

Except as modified in this article, wiring methods shall comply with Chapters 1 through 4 of this Code.

**517.13 Equipment Grounding Conductor for Receptacles and Fixed Electrical Equipment in Patient Care Spaces.**

Wiring serving patient care spaces shall comply with the requirements of 517.13(A) and (B).

*Exception: Luminaires more than 2.3 m (7½ ft) above the floor and switches located outside of the patient care vicinity shall be permitted to be connected to an equipment grounding return path complying with the requirements of 517.13(A) or (B).*

**(A) Wiring Methods.**

All branch circuits serving patient care spaces shall be provided with an effective ground-fault current path by installation in a metal raceway system or a cable having a metallic armor or sheath assembly. The metal raceway system, metallic cable armor, or sheath assembly shall itself qualify as an equipment grounding conductor in accordance with 250.118.

**(B) Insulated Equipment Grounding Conductors and Insulated Equipment Bonding Jumpers.**

**(1) General.**

An insulated copper equipment grounding conductor that is clearly identified along its entire length by green insulation and installed with the branch circuit conductors within the wiring method in accordance with 517.13(A) shall be directly connected to the following:

- (1) Grounding terminals of all receptacles other than isolated ground receptacles
- (2) Metal outlet boxes, metal device boxes, or metal enclosures
- (3) Non-current-carrying conductive surfaces of fixed electrical equipment likely to become energized that are subject to personal contact, operating at over 100 volts

*Exception No. 1: For other than isolated ground receptacles, an insulated equipment bonding jumper that directly connects to the equipment grounding conductor shall be permitted to connect the box and receptacle(s) to the equipment grounding conductor. Isolated ground receptacles shall be connected in accordance with 517.16.*

*Exception No. 2: Metal faceplates shall be connected to an effective ground-fault current path by means of a metal mounting screw(s) securing the faceplate to a metal yoke or strap of a receptacle or to a metal outlet box.*

**(2) Sizing.**

Equipment grounding conductors and equipment bonding jumpers shall be sized in accordance with 250.122.

**517.14 Panelboard Bonding.**

The equipment grounding terminal buses of the normal and essential branch-circuit panelboards serving the same individual patient care vicinity shall be connected together with an insulated continuous copper conductor not smaller than 10 AWG. Where two or more panelboards serving the same individual patient care vicinity are served from separate transfer switches on the essential electrical system, the equipment grounding terminal buses of those panelboards shall be connected together with an insulated continuous copper conductor not smaller than 10 AWG. This conductor shall be permitted to be broken in order to terminate on the equipment grounding terminal bus in each panelboard.

*Exception: The insulated continuous copper conductor not smaller than 10 AWG shall be permitted to be terminated on listed connections to aluminum or copper busbars not smaller than 6 mm thick × 50 mm wide (¼ in. thick × 2 in. wide) and of sufficient length to accommodate the number of terminations necessary for the bonding of the panelboards. The busbar shall be securely fastened and installed in an accessible location.*

**517.16 Use of Isolated Ground Receptacles.**

An isolated ground receptacle, if used, shall not defeat the purposes of the safety features of the grounding systems detailed in 517.13. [99:6.3.2.2.5(A)]

**(A) Inside of a Patient Care Vicinity.**

An isolated ground receptacle shall not be installed within a patient care vicinity. [99:6.3.2.2.5(B)]

**(B) Outside of a Patient Care Vicinity.**

Isolated ground receptacle(s) installed in patient care spaces outside of a patient care vicinity(s) shall comply with 517.16(B)(1) and (B)(2).

**(1)**

The equipment grounding terminals of isolated ground receptacles installed in branch circuits for patient care spaces shall be connected to an insulated equipment grounding conductor in accordance with 250.146(D) installed in a wiring method described in 517.13(A).

The equipment grounding conductor connected to the equipment grounding terminals of isolated ground receptacles in patient care spaces shall be clearly identified along the equipment grounding conductor's entire length by green insulation with one or more yellow stripes.

**(2)**

The insulated equipment grounding conductor required in 517.13(B)(1) shall be clearly identified along its entire length by green insulation, with no yellow stripes, and shall not be connected to the grounding terminals of isolated equipment ground receptacles but shall be connected to the box or enclosure indicated in 517.13(B)(1)(2) and to non-current-carrying conductive surfaces of fixed electrical equipment indicated in 517.13(B)(1)(3).

Informational Note No. 1: This type of installation is typically used where a reduction of electrical noise (electromagnetic interference) is necessary, and parallel grounding paths are to be avoided.

Informational Note No. 2: Care should be taken in specifying a system containing isolated ground receptacles, because the impedance of the effective ground-fault current path is dependent upon the equipment grounding conductor(s) and does not benefit from any conduit or building structure in parallel with the equipment grounding conductor.

**517.17–21** Ground-Fault Protection of Equipment.**(A)** Applicability.

The requirements of 517.17 shall apply to buildings or portions of buildings containing health care facilities with Category 1 spaces or utilizing electrical life-support equipment, and buildings that provide the required essential utilities or services for the operation of Category 1 spaces or electrical life-support equipment.

**(B)** Feeders.

Where ground-fault protection of equipment is provided for operation of the service disconnecting means or feeder disconnecting means as specified by 230.95 or 215.10, an additional step of ground-fault protection shall be provided in all next level feeder disconnecting means downstream toward the load. Such protection shall consist of overcurrent devices and current transformers or other protective equipment that shall cause the feeder disconnecting means to open.

The additional levels of ground-fault protection of equipment shall not be installed on the load side of an essential electrical system transfer switch.

**(C)** Selectivity.

Ground-fault protection of equipment for operation of the service and feeder disconnecting means shall be fully selective such that the feeder device, but not the service device, shall open on ground faults on the load side of the feeder device. Separation of ground-fault protection time-current characteristics shall conform to manufacturer's recommendations and shall consider all required tolerances and disconnect operating time to achieve 100 percent selectivity.

Informational Note: See 230.95, Informational Note, for transfer of alternate source where ground-fault protection is applied.

**(D)** Testing.

When ground-fault protection of equipment is first installed, each level shall be performance tested to ensure compliance with 517.17(C). This testing shall be conducted by a qualified person(s) using a test process in accordance with the instruction provided with the equipment. A written record of this testing shall be made and shall be available to the authority having jurisdiction.

**517.18–24** Category 2 Spaces.

**(A) Patient Bed Location.**

Each patient bed location shall be supplied by at least two branch circuits, one from the critical branch and one from the normal system. All branch circuits from the normal system shall originate in the same panelboard. The electrical receptacles or the cover plate for the electrical receptacles supplied from the critical branch shall have a distinctive color or marking so as to be readily identifiable and shall also indicate the panelboard and branch-circuit number supplying them.

Branch circuits serving patient bed locations shall not be part of a multiwire branch circuit.

*Exception No. 1: Branch circuits serving only special-purpose outlets or receptacles, such as portable X-ray outlets, shall not be required to be served from the same distribution panel or panels.*

*Exception No. 2: The requirements of 517.18(A) shall not apply to patient bed locations in clinics, medical and dental offices, and outpatient facilities; psychiatric, substance abuse, and rehabilitation hospitals; sleeping rooms of nursing homes; and limited care facilities meeting the requirements of 517.10(B)(2).*

*Exception No. 3: A Category 2 patient bed location served from two separate transfer switches on the critical branch shall not be required to have circuits from the normal system.*

*Exception No. 4: Circuits served by Type 2 essential electrical systems shall be permitted to be fed by the equipment branch of the essential electrical system.*

**(B) Patient Bed Location Receptacles.****(1) Minimum Number and Supply.**

Each patient bed location shall be provided with a minimum of eight receptacles.

**(2) Receptacle Requirements.**

The receptacles required in 517.18(B)(1) shall be permitted to be of the single, duplex, or quadruplex type or any combination of the three. All receptacles shall be listed "hospital grade" and shall be so identified. The grounding terminal of each receptacle shall be connected to an insulated copper equipment grounding conductor sized in accordance with Table 250.122.

*Exception No. 1: The requirements of 517.18(B)(1) and (B)(2) shall not apply to psychiatric, substance abuse, and rehabilitation hospitals meeting the requirements of 517.10(B)(2).*

*Exception No. 2: Psychiatric security rooms shall not be required to have receptacle outlets installed in the room.*

Informational Note: It is not intended that there be a total, immediate replacement of existing non-hospital grade receptacles. It is intended, however, that non-hospital grade receptacles be replaced with hospital grade receptacles upon modification of use, renovation, or as existing receptacles need replacement.

**(C) Designated Category 2 Pediatric Locations.**

Receptacles that are located within patient rooms, bathrooms, playrooms, and activity rooms of pediatric units or spaces with similar risk as determined by the health care facility's governing body by conducting a risk assessment, other than infant nurseries, shall be listed and identified as "tamper resistant" or shall employ a listed tamper-resistant cover. [99:6.3.2.2.1(D)]

**517.19–25 Category 1 Spaces.**

**(A) Patient Bed Location Branch Circuits.**

Each patient bed location shall be supplied by at least two branch circuits, one or more from the critical branch and one or more from the normal system. At least one branch circuit from the critical branch shall supply an outlet(s) only at that bed location.

The electrical receptacles or the cover plates for the electrical receptacles supplied from the life safety and critical branches shall have a distinctive color or marking so as to be readily identifiable. [99:6.7.2.2.5(B)]

All branch circuits from the normal system shall be from a single panelboard. Critical branch receptacles shall be identified and shall also indicate the panelboard and circuit number supplying them.

Branch circuits serving patient bed locations shall not be part of a multiwire branch circuit.

*Exception No. 1: Branch circuits serving only special-purpose receptacles or equipment in Category 1 spaces shall be permitted to be served by other panelboards.*

*Exception No. 2: Category 1 spaces served from two separate critical branch transfer switches shall not be required to have circuits from the normal system.*

**(B) Patient Bed Location Receptacles.****(1) Minimum Number and Supply.**

Each patient bed location shall be provided with a minimum of 14 receptacles, with at least one connected to either of the following:

- (1) The normal system branch circuit required in 517.19(A)
- (2) A critical branch circuit supplied by a different transfer switch than the other receptacles at the same patient bed location

**(2) Receptacle Requirements.**

The receptacles required in 517.19(B)(1) shall be permitted to be of the single, duplex, or quadruplex type or any combination of the three. All receptacles shall be listed "hospital grade" and shall be so identified. The grounding terminal of each receptacle shall be connected to the reference grounding point by means of an insulated copper equipment grounding conductor.

**(C) Operating Room Receptacles.****(1) Minimum Number and Supply.**

Each operating room shall be provided with a minimum of 36 receptacles divided between at least two branch circuits. At least 12 receptacles, but no more than 24, shall be connected to either of the following:

- (1) The normal system branch circuit required in 517.19(A)
- (2) A critical branch circuit supplied by a different transfer switch than the other receptacles at the same location

**(2) Receptacle Requirements.**

The receptacles shall be permitted to be of the locking or nonlocking type and of the single, duplex, or quadruplex types or any combination of the three.

All nonlocking-type receptacles shall be listed hospital grade and so identified. The grounding terminal of each receptacle shall be connected to the reference grounding point by means of an insulated copper equipment grounding conductor.

**(D) Patient Care Vicinity Grounding and Bonding (Optional).**

A patient care vicinity shall be permitted to have a patient equipment grounding point. The patient equipment grounding point, where supplied, shall be permitted to contain one or more listed grounding and bonding jacks. An equipment bonding jumper not smaller than 10 AWG shall be used to connect the grounding terminal of all grounding-type receptacles to the patient equipment grounding point. The bonding conductor shall be permitted to be arranged centrally or looped as convenient.

Informational Note: Where there is no patient equipment grounding point, it is important that the distance between the reference grounding point and the patient care vicinity be as short as possible to minimize any potential differences.

**(E) Equipment Grounding and Bonding.**

Where a grounded electrical distribution system is used and metal feeder raceway or Type MC or MI cable that qualifies as an equipment grounding conductor in accordance with 250.118 is installed, grounding of enclosures and equipment, such as panelboards, switchboards, and switchgear, shall be ensured by one of the following bonding means at each termination or junction point of the metal raceway or Type MC or MI cable:

- (1) A grounding bushing and a continuous copper bonding jumper, sized in accordance with 250.122, with the bonding jumper connected to the junction enclosure or the ground bus of the panel
- (2) Connection of feeder raceways or Type MC or MI cable to threaded hubs or bosses on terminating enclosures
- (3) Other approved devices such as bonding-type locknuts or bushings. Standard locknuts shall not be used for bonding.

**(F) Additional Protective Techniques in Category 1 Spaces (Optional).**

Isolated power systems shall be permitted to be used for Category 1 spaces, and, if used, the isolated power system equipment shall be listed as isolated power equipment. The isolated power system shall be designed and installed in accordance with 517.160.

*Exception: The audible and visual indicators of the line isolation monitor shall be permitted to be located at the nursing station for the area being served.*

**(G) Isolated Power System Equipment Grounding.**

Where an isolated ungrounded power source is used and limits the first-fault current to a low magnitude, the equipment grounding conductor associated with the secondary circuit shall be permitted to be run outside of the enclosure of the power conductors in the same circuit.

Informational Note: Although it is permitted to run the equipment grounding conductor outside of the conduit, it is safer to run it with the power conductors to provide better protection in case of a second ground fault.

**(H) Special-Purpose Receptacle Grounding.**

The equipment grounding conductor for special-purpose receptacles, such as the operation of mobile X-ray equipment, shall be extended to the reference grounding points of branch circuits for all locations likely to be served from such receptacles. Where such a circuit is served from an isolated ungrounded system, the equipment grounding conductor shall not be required to be run with the power conductors; however, the equipment grounding terminal of the special-purpose receptacle shall be connected to the reference grounding point.

**517.20–29 Wet Procedure Locations.**



**(A) Receptacles and Fixed Equipment.**

Wet procedure locations shall be provided with special protection against electric shock.

[99:6.3.2.3.1]

This special protection shall be provided as follows:

- (1) Isolated power systems that remain in operation in the event of a single line-to-ground fault condition that inherently limits the possible ground-fault current due to a first fault to a low value, without interrupting the power supply.

Informational Note No. 1: Isolated power systems can eliminate the danger of electric shock to patients who might be more susceptible to leakage current and unable to move in their beds.

- (2) Power distribution system in which the power supply is interrupted if the ground-fault current does, in fact, exceed the trip value of a Class A GFCI.

Informational Note No. 2: See ANSI/UL 943-2018, *Ground-Fault Circuit-Interrupters*, Annex E, and, in accordance with 110.3(B), the manufacturers' installation instructions of listed ground-fault circuit interrupters for information on the supply connection of life-support equipment to circuits providing ground-fault circuit-interrupter (GFCI) protection of personnel at outlets.

[99:6.3.2.3.2]

*Exception: Branch circuits supplying only listed, fixed, therapeutic, and diagnostic equipment shall be permitted to be supplied from a grounded service, single- or 3-phase system if the following conditions are met:*

- (1) *Wiring for grounded and isolated circuits does not occupy the same raceway.*
- (2) *All conductive surfaces of the equipment are connected to an insulated copper equipment grounding conductor.*

**(B) Isolated Power Systems.**

Where an isolated power system is utilized, the isolated power equipment shall be listed as isolated power equipment, and the isolated power system shall be designed and installed in accordance with 517.160.

Informational Note: See Part IV of Article 680 for requirements on the installation of therapeutic pools and tubs.

**517.24–30** Ground-Fault Circuit-Interrupter Protection for Personnel in Category 2 and Category 1 Spaces.

Receptacles shall not be required in bathrooms or toilet rooms. [99:6.3.2.2.2(D)]

Receptacles located in patient bathrooms and toilet rooms in Category 2 spaces shall have ground-fault circuit-interrupter protection in accordance with 210.8(B)(1).

Ground-fault circuit-interrupter protection for personnel shall not be required for receptacles installed in those Category 2 and Category 1 spaces where a basin, sink, or other similar plumbing fixture is installed in the patient bed location.

Informational Note: See ANSI/UL 943-2018, *Ground-Fault Circuit-Interrupters*, Annex E, and, in accordance with 110.3(B), the manufacturers' installation instructions of listed ground-fault circuit interrupters for information on the supply connection of life-support equipment to circuits providing ground-fault circuit-interrupter (GFCI) protection of personnel at outlets.

**517.22–35** Demand Factors.

Demand factors for general-use receptacles and individual branch circuits not exceeding 150 volts to ground shall be permitted to be applied in accordance with 517.22(A) and (B).

**(A) General-Use Receptacles.**

In addition to demand factors allowed by other sections of this *Code*, the demand factor for general-use receptacles shall be permitted to be calculated in accordance with Table 517.22(A).

Table 517.22(A) Demand Factors for General-Use Receptacles in Health Care Facilities

<b>Portion of Receptacle Load to Which Demand Factor Applies</b>	<b>Demand Factor (%)</b>
First 5.0 kVA or less	100
Second 5.0 kVA to 10kVA	50
Remainder over 10 kVA	25

Informational Note: See 220.14(l) for the calculation of general-use receptacle loads.

**(B) Receptacles for Designated Equipment.**

Individual branch circuits supplying receptacles for equipment shall be permitted to be calculated in accordance with Table 517.22(B).

Table 517.22(B) Demand Factors for Equipment Supplied by Individual Branch Circuits in Health Care Facilities

<b>Equipment Supplied by Individual Branch Circuits</b>	<b>Demand Factor (%)</b>
Largest five connected loads	100
Six or more connected loads	50

Informational Note: See 220.60 for noncoincident load calculations.

**Part III. Essential Electrical System (EES)****517.25–40** Essential Electrical Systems for Health Care Facilities.

Type 1 and Type 2 essential electrical systems (EES) for health care facilities shall comprise separate branches capable of supplying a limited amount of lighting and power service, which is considered essential for life safety and orderly cessation of procedures during the time normal electrical service is interrupted for any reason.

Informational Note: See NFPA 99-2021, *Health Care Facilities Code*, for information on the need for an essential electrical system.

**517.26–42** Application of Other Articles.

The life safety branch of the essential electrical system shall meet the requirements of Article 700, except as amended as follows:

- (1) Section 700.4 shall not apply.
- (2) Section 700.10(D) shall not apply.
- (3) Section 700.17 shall be replaced with the following: Branch circuits that supply emergency lighting shall be installed to provide service from a source in accordance with 700.12 when normal supply for lighting is interrupted or where single circuits supply luminaires containing secondary batteries.
- (4) Section 700.32 shall not apply.

Informational Note No. 1: See NFPA 110-2019, *Standard for Emergency and Standby Power Systems*, for additional information.

Informational Note No. 2: See 517.29 and NFPA 99-2021, *Health Care Facilities Code*, for additional information.

**517.29–43** Type 1 Essential Electrical Systems.

Informational Note: Type 1 essential electrical systems are comprised of three separate branches capable of supplying a limited amount of lighting and power service that is considered essential for life safety and effective facility operation during the time the normal electrical service is interrupted for any reason. These three separate branches are the life safety, critical, and equipment branches. [99:A.6.7.2.3]

**(A) Applicability.**

The requirements of 517.29 through 517.35 shall apply to Type 1 essential electrical systems. Type 1 systems shall be required for Category 1 spaces. Type 1 systems shall be permitted to serve Category 2, Category 3, and Category 4 spaces.

Informational Note No. 1: See NFPA 99-2021, *Health Care Facilities Code*, for performance, maintenance, and testing requirements of essential electrical systems in hospitals. See NFPA 20-2019, *Standard for the Installation of Stationary Pumps for Fire Protection*, for installation of centrifugal fire pumps.

Informational Note No. 2: See NFPA 99-2021, *Health Care Facilities Code*, 6.7.5 and 6.7.6, for additional information on Type 1 and Type 2 essential electrical systems.

**(B) Type 1 Essential Electrical Systems.**

Category 1 spaces shall be served by a Type 1 essential electrical system. [99:6.4.1]

Category 1 spaces shall not be served by a Type 2 EES. [99:6.4.2]

**517.30–45 Sources of Power.**

**(A) Two Independent Power Sources.**

Essential electrical systems shall have a minimum of the following two independent sources of power: a normal source generally supplying the entire electrical system and one or more alternate sources for use when the normal source is interrupted. [99:6.7.1.1.2]

**(B) Types of Normal Power Sources.**

Normal power sources shall be permitted to be any of the following:

- (1) Utility supply power
- (2) Generation units
- (3) Health care microgrid
- (4) Fuel cells

**(C) Types of Alternate Power Sources.**

Alternate power sources shall be permitted to be any of those specified in 517.30(C)(1) through (C)(5).

**(1) Utility Supply Power.**

Where utility power is used as the normal source, utility power shall not be permitted to be used as the alternate source unless permitted elsewhere in this article.

Informational Note: See 517.35 and 517.45 for essential system loads that can be supplied from dual sources of utility supply power.

**(2) Generating Units.**

Where the normal source of power consists of generating units on the premises, the alternate source shall be either another generating set or an external utility service. [99:6.7.1.1.3]

**(3) Fuel Cell Systems.**

Fuel cell systems shall be permitted to serve as the alternate power source for all or part of an essential electrical system. [99:6.7.1.5.1]

- (a) Installation of fuel cells shall comply with the requirements in Parts I through VII of Article 692 for 1000 volts or less and Part VIII for over 1000 volts.
- (b)  $N + 1$  units shall be provided where  $N$  units have sufficient capacity to supply the demand load of the portion of the system served.
- (c) Systems shall be able to assume loads within 10 seconds of loss of normal power source.
- (d) Systems shall have a continuing source of fuel supply, together with sufficient on-site fuel storage for the essential system type.
- (e) Where life safety and critical portions of the distribution system are present, a connection shall be provided for a portable diesel generator.

Informational Note: See NFPA 853-2020, *Standard for the Installation of Stationary Fuel Cell Power Systems*, for information on installation of stationary fuel cells.

**(4) Energy Storage Systems.**

Energy storage systems shall be permitted to serve as the alternate source for all or part of an essential electrical system.

Informational Note: See NFPA 111-2019, *Standard on Stored Electrical Energy Emergency and Standby Power Systems*, for information on the installation of energy storage systems.

**(5) Health Care Microgrid.**

- (a) If health care microgrid power is used as the normal source, health care microgrid power shall not be permitted to be used as the alternate source.
- (b) Essential electrical systems shall be permitted to be supplied by a health care microgrid that also supplies nonessential loads. The health care microgrid shall be permitted to share distributed resources with the normal system. Health care microgrid systems shall be designed with sufficient reliability to provide effective facility operation consistent with the facility emergency operations plan. Health care microgrid system components shall not be compromised by failure of the normal source.

Informational Note: See NFPA 99-2021, *Health Care Facilities Code*, for information on health care microgrids.

**(D) Location of Essential Electrical System Components.**

Essential electrical system components shall be located to minimize interruptions caused by natural forces common to the area (e.g., storms, floods, earthquakes, or hazards created by adjoining structures or activities). [99:6.2.4.1]

**(1) Services.**

Installation of electrical service distribution equipment shall be located to reduce possible interruption of normal electrical services resulting from natural or manmade causes as well as internal wiring and equipment failures.

**(2) Feeders.**

Feeders shall be located to provide physical separation of the feeders of the alternate source and from the feeders of the normal electrical source to prevent possible simultaneous interruption.

[99:6.2.4.3]

Informational Note: Facilities in which the normal source of power is supplied by two or more separate central station-fed services experience greater than normal electrical service reliability than those with only a single feed. Such a dual source of normal power consists of two or more electrical services fed from separate generator sets or a utility distribution network that has multiple power input sources and is arranged to provide mechanical and electrical separation so that a fault between the facility and the generating sources is not likely to cause an interruption of more than one of the facility service feeders.

**517.31–46** Requirements for the Essential Electrical System.**(A) Separate Branches.**

Type 1 essential electrical systems shall be comprised of three separate branches capable of supplying a limited amount of lighting and power service that is considered essential for life safety and effective hospital operation during the time the normal electrical service is interrupted for any reason. The three branches are life safety, critical, and equipment.

The division between the branches shall occur at transfer switches where more than one transfer switch is required. [99:6.7.2.3.1]

**(B) Transfer Switches.**

Transfer switches shall be in accordance with one of the following:

- (1) The number of transfer switches to be used shall be based on reliability and design. Each branch of the essential electrical system shall have one or more transfer switches.
- (2) One transfer switch shall be permitted to serve one or more branches in a facility with a continuous load on the switch of 150 kVA (120 kW) or less. [99:6.7.6.2.1.4]

Informational Note No. 1: See NFPA 99-2021, *Health Care Facilities Code*, 6.7.3.1, 6.7.2.2.5, 6.7.2.2.5.15, and 6.7.2.2.7, for more information on transfer switches.

Informational Note No. 2: See Informational Note Figure 517.31(B)(a).

Informational Note No. 3: See Informational Note Figure 517.31(B)(b).

**Figure Informational Note Figure 517.31(B)(a) Type 1 Essential Electrical System — Minimum Requirement (Greater Than 150 kVA) for Transfer Switch Arrangement.**

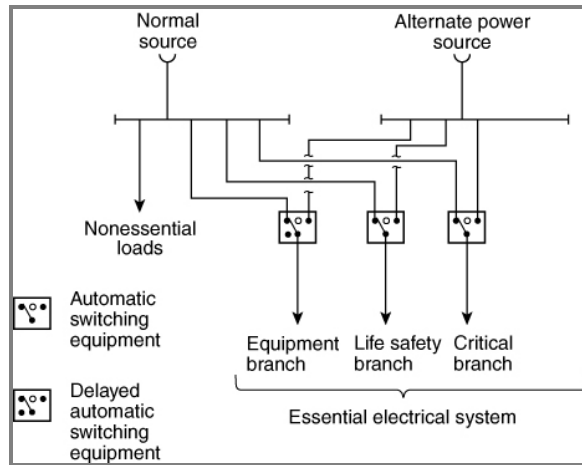

**Figure Informational Note Figure 517.31(B)(b) Type 1 Essential Electrical System — Minimum Requirement (150 kVA or Less) for Transfer Switch Arrangement.**

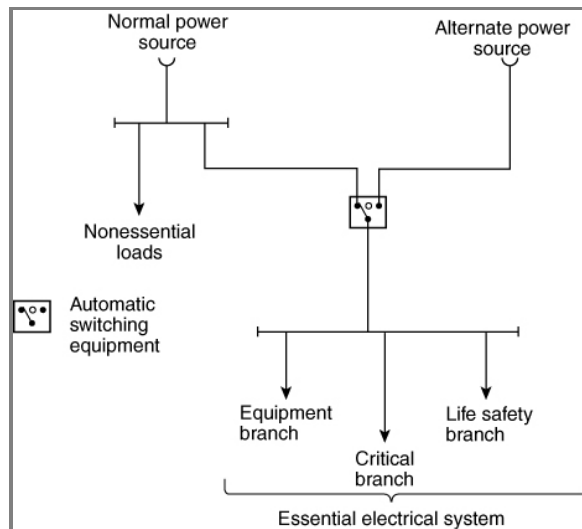

**(1) Optional Loads.**

Loads served by the generating equipment not specifically named in this article shall be served by their own transfer switches such that the following conditions apply:

- (1) These loads shall not be transferred if the transfer will overload the generating equipment.
- (2) These loads shall be automatically shed upon generating equipment overloading.

**(2) Contiguous Facilities.**

Hospital power sources and alternate power sources shall be permitted to serve the essential electrical systems of contiguous or same-site facilities.

**(C) Wiring Requirements.****(1) Separation from Other Circuits.**

The life safety branch and critical branch [of the essential electrical system] shall be kept independent of all other wiring and equipment. [99:6.7.5.2.1]

(a) Raceways, cables, or enclosures of the life safety and critical branch shall be readily identified as components of the essential electrical system (EES). Boxes and enclosures (including transfer switches, generators, and power panels) shall be field- or factory-marked and identified as components of the EES. Raceways and cables shall be field- or factory-marked as components of the EES at intervals not to exceed 7.6 m (25 ft).

(b) Conductors of the life safety branch or critical branch shall not enter the same raceways, boxes, or cabinets with each other or any other wiring system. Branch conductors shall be permitted to occupy common equipment, raceways, boxes, or cabinets of other circuits not part of the life safety branch and critical branch where such wiring complies with one of the following:

- (3) Is in transfer equipment enclosures
- (4) Is in exit or emergency luminaires supplied from two sources
- (5) Is in a common junction box attached to exit or emergency luminaires supplied from two sources
- (6) Is for two or more circuits supplied from the same branch and same transfer switch

(g) The wiring of the equipment branch shall be permitted to occupy the same raceways, boxes, or cabinets of other circuits that are not part of the essential electrical system.

(h) Where Category 2 locations are served from two separate transfer switches on the essential electrical system in accordance with 517.18(A), Exception No. 3, the Category 2 circuits from the two separate systems shall be kept independent of each other.

(i) Where Category 1 locations are served from two separate transfer switches on the essential electrical system in accordance with 517.19(A), Exception No. 2, the critical care circuits from the two separate systems shall be kept independent of each other.

**(2) Isolated Power Systems.**

Where isolated power systems are installed in any of the areas in 517.34(A)(1) and (A)(2), each system shall be supplied by an individual circuit serving no other load.

**(3) Mechanical Protection of the Essential Electrical System.**

The wiring of the life safety and critical branches shall be mechanically protected by raceways. Where installed as branch circuits in patient care spaces, the installation shall comply with the requirements of 517.13(A) and (B) and 250.118. Only the following wiring methods shall be permitted:

- (1) Nonflexible metal raceways, Type MI cable, Type RTRC marked with the suffix -XW, or Schedule 80 PVC conduit. Nonmetallic raceways shall not be used for branch circuits that supply patient care spaces.
- (2) Where encased in not less than 50 mm (2 in.) of concrete, Schedule 40 PVC conduit, flexible nonmetallic or jacketed metallic raceways, or jacketed metallic cable assemblies listed for installation in concrete. Nonmetallic raceways shall not be used for branch circuits that supply patient care spaces.
- (3) Listed flexible metal raceways and listed metal sheathed cable assemblies, as follows:
  - (4) Where used in listed prefabricated medical headwalls
  - (5) In listed office furnishings
  - (6) Where fished into existing walls or ceilings, not otherwise accessible and not subject to physical damage
  - (7) Where necessary for flexible connection to equipment
  - (8) For equipment that requires a flexible connection due to movement, vibration, or operation
  - (9) Luminaires installed in ceiling structures
- (10) Flexible power cords of appliances or other utilization equipment connected to the essential electrical system.
- (11) Cables for Class 2 or Class 3 systems permitted in Part VI of this article, with or without raceways.

Informational Note: See 517.13 for additional grounding requirements in patient care areas.

**(D) Capacity of Systems.**

The essential electrical system shall have the capacity and rating to meet the maximum actual demand likely to be produced by the connected load.

Feeders shall be sized in accordance with 215.2 and Part III of Article 220. The alternate power source(s) required in 517.30 shall have the capacity and rating to meet the demand produced by the load at any given time.

Demand calculations for sizing of the alternate power source(s) shall be based on any of the following:

- (1) Prudent demand factors and historical data
- (2) Connected load
- (3) Feeder calculations
- (4) Any combination of the above

The sizing requirements in 700.4 and 701.4 shall not apply to alternate sources.

**(E) Receptacle Identification.**

The electrical receptacles or the cover plates for the electrical receptacles supplied from the life safety and critical branches shall have a distinctive color or marking so as to be readily identifiable. [99:6.7.2.2.5(B)]



**(F) Feeders from Alternate Power Source.**

A single feeder supplied by a local or remote alternate power source shall be permitted to supply the essential electrical system to the point at which the life safety, critical, and equipment branches are separated. Installation of the transfer equipment shall be permitted at other than the location of the alternate power source.

**(G) Coordination.**

Overcurrent protective devices serving the essential electrical system shall be coordinated for the period of time that a fault's duration extends beyond 0.1 second.

*Exception No. 1: Coordination shall not be required between transformer primary and secondary overcurrent protective devices where only one overcurrent protective device or set of overcurrent protective devices exists on the transformer secondary.*

*Exception No. 2: Coordination shall not be required between overcurrent protective devices of the same size (ampere rating) in series.*

Informational Note No. 1: The terms *coordination* and *coordinated* as used in this section do not cover the full range of overcurrent conditions.

Informational Note No. 2: See 517.17(C) for information on requirements for the coordination of ground-fault protection.

**517.32–47 Branches Requiring Automatic Connection.****(A) Life Safety and Critical Branch Used in a Type 1 EES.**

Those functions of patient care depending on lighting or appliances that are connected to the essential electrical system shall be divided into the life safety branch and the critical branch, as described in 517.33 and 517.34.

**(B) Life Safety and Critical Branch Used in a Type 2 EES.**

The life safety and critical branches shall be installed and connected to the alternate power source specified in 517.41(A) and 517.41(B) so that all functions specified herein for the life safety and critical branches are automatically restored to operation within 10 seconds after interruption of the normal source. [99:6.7.5.3.1]

**517.33–50 Life Safety Branch.**

The life safety branch shall be limited to circuits essential to life safety. [99:6.7.5.1.2.3]

No functions other than those listed in 517.33(A) through (H) shall be connected to the life safety branch. The life safety branch shall supply power as follows:

**(A) Illumination of Means of Egress.**

Illumination of means of egress such as lighting required for corridors, passageways, stairways, and landings at exit doors, and all necessary ways of approach to exits. Switching arrangements to transfer patient corridor lighting in hospitals from general illumination circuits to night illumination circuits shall be permitted, if only one of two circuits can be selected and both circuits cannot be extinguished at the same time.

Informational Note: See NFPA 101-2021, *Life Safety Code*, Sections 7.8 and 7.9.

**(B) Exit Signs.**

Exit signs and exit directional signs.

Informational Note: See NFPA 101-2021, *Life Safety Code*, Section 7.10.

**(C) Alarm and Alerting Systems.**

Alarm and alerting systems including the following:

- (1) Fire alarm systems
- (2) Alarm and alerting systems (other than fire alarm systems) shall be connected to the life safety branch or critical branch. [99:6.7.5.1.2.5]
- (3) Alarms for systems used for the piping of nonflammable medical gases
- (4) Mechanical, control, and other accessories required for effective life safety systems operation shall be permitted to be connected to the life safety branch.

**(D) Communications Systems.**

Hospital communications systems, where used for issuing instructions during emergency conditions. [99:6.7.5.1.2.4(3)]

**(E) Generator Set Locations.**

Generator set locations as follows:

- (1) Task illumination
- (2) Battery charger for emergency battery-powered lighting unit(s)
- (3) Select receptacles at the generator set location and essential electrical system transfer switch locations

[99:6.7.5.1.2.4(4)]

**(F) Generator Set Accessories.**

Loads dedicated to a specific generator, including the fuel transfer pump(s), ventilation fans, electrically operated louvers, controls, cooling system, and other generator accessories essential for generator operation, shall be connected to the life safety branch or to the output terminals of the generator with overcurrent protective devices. [99:6.7.5.1.2.6]

**(G) Elevators.**

Elevator cab lighting, control, communications, and signal systems. [99:6.7.5.1.2.4(5)]

**(H) Automatic Doors.**

Electrically powered doors used for building egress. [99:6.7.5.1.2.4(6)]

**517.34–51** Critical Branch.

**(A) Task Illumination, Fixed Equipment, and Selected Receptacles.**

The critical branch shall supply power for task illumination, fixed equipment, select receptacles, and select power circuits serving the following spaces and functions related to patient care:

- (1) Category 1 spaces where deep sedation or general anesthesia is administered, task illumination, select receptacles, and fixed equipment
- (2) Task illumination and select receptacles in the following:
  - (3) Patient care spaces, including infant nurseries, selected acute nursing areas, psychiatric bed areas (omit receptacles), and ward treatment rooms
  - (4) Medication preparation spaces
  - (5) Pharmacy dispensing spaces
  - (6) Nurses' stations — unless adequately lighted by corridor luminaires
- (7) Additional specialized patient care task illumination and receptacles, where needed
- (8) Nurse call systems
- (9) Blood, bone, and tissue banks
- (10) Telecommunications entrance facility, telecommunications equipment rooms, and telecommunication rooms and equipment in these rooms
- (11) Task illumination, select receptacles, and select power circuits for the following areas:
  - (12) Category 1 or 2 spaces with at least one duplex receptacle per patient bed location, and task illumination as required by the governing body of the health care facility
  - (13) Angiographic labs
  - (14) Cardiac catheterization labs
  - (15) Coronary care units
  - (16) Hemodialysis rooms or areas
  - (17) Emergency room treatment areas (select)
  - (18) Human physiology labs
  - (19) Intensive care units
  - (20) Postoperative recovery rooms (select)
- (21) Clinical IT-network equipment
- (22) Wireless phone and paging equipment for clinical staff communications
- (23) Additional task illumination, receptacles, and select power circuits needed for effective facility operation, including single-phase fractional horsepower motors, which are permitted to be connected to the critical branch

[99:6.7.5.1.3.2]

**(B) Switching.**

It shall be permitted to control task illumination on the critical branch.

**(C) Subdivision of the Critical Branch.**

The critical branch shall be permitted to be subdivided into two or more branches. [99:6.7.5.1.3.1]

Informational Note: It is important to analyze the consequences of supplying an area with only critical branch power when failure occurs between the area and the transfer switch. Some proportion of normal and critical power or critical power from separate transfer switches might be appropriate.

**517.35– 52** Equipment Branch Connection to Alternate Power Source.

The equipment branch shall be installed and connected to the alternate power source such that the equipment described in 517.35(A) is automatically restored to operation at appropriate time-lag intervals following the energizing of the life safety and critical branches. [99:6.7.5.1.4.2(A)]

The arrangement of the connection to the alternate power source shall also provide for the subsequent connection of equipment described in 517.35(B). [99:6.7.5.1.4.2(B)]

*Exception: For essential electrical systems under 150 kVA, deletion of the time-lag intervals feature for delayed automatic connection to the equipment system shall be permitted.*

**(A)** Equipment for Delayed Automatic Connection.

The following equipment shall be permitted to be arranged for delayed automatic connection to the alternate power source:

- (1) Central suction systems serving medical and surgical functions, including controls, with such suction systems permitted to be placed on the critical branch
- (2) Sump pumps and other equipment required to operate for the safety of major apparatus, including associated control systems and alarms
- (3) Compressed air systems serving medical and surgical functions, including controls with such air systems permitted to be placed on the critical branch
- (4) Smoke control and stair pressurization systems
- (5) Kitchen hood supply or exhaust systems, or both, if required to operate during a fire in or under the hood
- (6) Supply, return, and exhaust ventilating systems for the following:
  - (7) Airborne infectious/isolation rooms
  - (8) Protective environment rooms
  - (9) Exhaust fans for laboratory fume hoods
  - (10) Nuclear medicine areas where radioactive material is used
  - (11) Ethylene oxide evacuation
  - (12) Anesthetic evacuation

**[99:6.7.5.1.4.3(A)]**

Where delayed automatic connection is not appropriate, the ventilation systems specified in 517.35(A)(6) shall be permitted to be placed on the critical branch. [99:6.7.5.1.4.3(B)]

- (13) Supply, return, and exhaust ventilating systems for operating and delivery rooms
- (14) Supply, return, exhaust ventilating systems and/or air-conditioning systems serving telephone equipment rooms and closets and data equipment rooms and closets

*Exception: Sequential delayed automatic connection to the alternate power source to prevent overloading the generator shall be permitted where engineering studies indicate it is necessary.*

**(B) Equipment for Delayed Automatic or Manual Connection.**

The following equipment shall be permitted to be arranged for either delayed automatic or manual connection to the alternate power source:

- (1) Heating equipment to provide heating for operating, delivery, labor, recovery, intensive care, coronary care, nurseries, infection/isolation rooms, emergency treatment spaces, and general patient rooms and pressure maintenance (jockey or make-up) pump(s) for water-based fire protection systems

*Exception: Heating of general patient rooms and infection/isolation rooms during disruption of the normal source shall not be required under any of the following conditions:*

- (1) *The outside design temperature is higher than  $-6.7^{\circ}\text{C}$  ( $20^{\circ}\text{F}$ ).*
- (2) *The outside design temperature is lower than  $-6.7^{\circ}\text{C}$  ( $20^{\circ}\text{F}$ ), and where a selected room(s) is provided for the needs of all confined patients, only such room(s) need be heated.*
- (3) *The facility is served by a dual source of normal power.*

Informational Note No. 1: The design temperature is based on the 97.5 percent design value as shown in Chapter 24 of the ASHRAE *Handbook of Fundamentals* (2013).

Informational Note No. 2: For a description of a dual source of normal power, see 517.30(D).

- (2) An elevator(s) selected to provide service to patient, surgical, obstetrical, and ground floors during interruption of normal power. In instances where interruption of normal power would result in other elevators stopping between floors, throw-over facilities shall be provided to allow the temporary operation of any elevator for the release of patients or other persons who may be confined between floors.
- (3) Hyperbaric facilities.
- (4) Hypobaric facilities.
- (5) Automatically operated doors.
- (6) Minimal electrically heated autoclaving equipment shall be permitted to be arranged for either automatic or manual connection to the alternate source.
- (7) Controls for equipment listed in 517.35.
- (8) Other selected equipment shall be permitted to be served by the equipment system.  
[99:6.7.5.1.4.4]

**517.40–60 Type 2 Essential Electrical Systems.**

Informational Note No. 1: Nursing homes and other limited care facilities can contain Category 1 and/or Category 2 patient care spaces, depending on the design and type of care administered in the facility. For Category 1 spaces, see 517.29 through 517.35. For Category 2 spaces not served by Type 1 essential electrical systems, see 517.40 through 517.44 .

Informational Note No. 2: Type 2 essential electrical systems are comprised of two separate branches capable of supplying a limited amount of lighting and power service that is considered essential for the protection of life and safety and effective operation of the institution during the time normal electrical service is interrupted for any reason. These two separate branches are the life safety and equipment branches. The number of transfer switches to be used should be based upon reliability, design, and load considerations. Each branch of the essential electrical system should have one or more transfer switches. One transfer switch should be permitted to serve one or more branches in a facility with a maximum demand on the essential electrical system of 150 kVA (120 kW). [99:A.6.7.6.2.1]

**(A) Applicability.**

The requirements of 517.40(C) through 517.44 shall apply to Category 2 spaces.

*Exception: The requirements of 517.40(C) through 517.44 shall not apply to freestanding buildings used as nursing homes and limited care facilities if the following apply:*

- (1) *Admitting and discharge policies are maintained that preclude the provision of care for any patient or resident who might need to be sustained by electrical life-support equipment.*
- (2) *No surgical treatment requiring general anesthesia is offered.*
- (3) *An automatic battery-operated system(s) or equipment shall be effective for at least 1½ hours and is otherwise in accordance with 700.12 and that shall be capable of supplying lighting for exit lights, exit corridors, stairways, nursing stations, medical preparation areas, boiler rooms, and communications areas. This system shall also supply power to operate all alarm systems.*

Informational Note: See NFPA 101-2021, *Life Safety Code*.

**(B) Category 1 Spaces in Inpatient Hospital Care Facilities.**

For those nursing homes and limited care facilities that admit patients who need to be sustained by electrical life-support equipment, the essential electrical system from the source to the portion of the facility where such patients are treated shall comply with the requirements of 517.29 through 517.35.

**(C) Facilities Contiguous or Located on the Same Site with Hospitals.**

Nursing homes and limited care facilities that are contiguous or located on the same site with a hospital shall be permitted to have their essential electrical systems supplied by the hospital.

**517.41–61 Required Power Sources.****(A) Two Independent Power Sources.**

Essential electrical systems shall have a minimum of the following two independent sources of power: a normal source generally supplying the entire electrical system and one or more alternate sources for use when the normal source is interrupted. [99:6.7.1.2.2]

**(B) Types of Power Sources.**

Where the normal source consists of generating units on the premises, the alternate power source shall be either another generating set or an external utility service. [99:6.7.1.1.3]

**(C) Location of Essential Electrical System Components.**

Essential electrical system components shall be located to minimize interruptions caused by natural forces common to the area (e.g., storms, floods, earthquakes, or hazards created by adjoining structures or activities). [99:6.2.4.1]

Installations of electrical services shall be located to reduce possible interruption of normal electrical services resulting from similar causes as well as possible disruption of normal electrical service due to internal wiring and equipment failures. [99:6.2.4.2]

Feeders shall be located to provide physical separation of the feeders of the alternate source and from the feeders of the normal electrical source to prevent possible simultaneous interruption. [99:6.2.4.3]

**517.42–62 Essential Electrical Systems for Nursing Homes and Limited Care Facilities.**

**(A) General.**

The [Type 2] essential electrical system shall be divided into the following two branches:

- (1) Life safety branch
- (2) Equipment branch

**[99:6.7.6.2.1.2]**

The division between the branches shall occur at transfer switches where more than one transfer switch is required. **[99:6.7.2.2.1]**

Informational Note No. 1: Type 2 essential electrical systems are comprised of two separate branches capable of supplying a limited amount of lighting and power service that is considered essential for the protection of life and safety and effective operation of the institution during the time normal electrical service is interrupted for any reason. These two separate branches are the life safety and equipment branches. **[99:A.6.7.6.2.1]**

Informational Note No. 2: The number of transfer switches to be used should be based upon reliability, design, and load considerations. Each branch of the essential electrical system should have one or more transfer switches. One transfer switch should be permitted to serve one or more branches in a facility with a maximum demand on the essential electrical system of 150 kVA (120 kW). **[99:A.6.7.6.2.1]**

Informational Note No. 3: For more information, see NFPA 99-2021, *Health Care Facilities Code*, 6.7.2.3.

**(B) Transfer Switches.**

The number of transfer switches to be used shall be based upon reliability, design, and load considerations. [99:6.7.2.2.3]

Transfer switches shall be in accordance with one of the following:

- (1) Each branch of the essential electrical system shall have one or more transfer switches. [99:6.7.2.2.3.1]
- (2) One transfer switch shall be permitted to serve one or more branches in a facility with a continuous load on the switch of 150 kVA (120 kW) or less. [99:6.7.2.2.3.2]

Informational Note No. 1: See NFPA 99-2021, *Health Care Facilities Code*, 6.7.2.2.4, 6.7.2.2.5, 6.7.2.2.5.15, and 6.7.2.2.7 for more information on transfer switches.

Informational Note No. 2: See Informational Note Figure 517.42(B)(a).

Informational Note No. 3: See Informational Note Figure 517.42(B)(b).

**Figure Informational Note Figure 517.42(B)(a) Type 2 Essential Electrical Systems (Nursing Home and Limited Health Care Facilities) — Minimum Requirement (Greater Than 150 kVA) for Transfer Switch Arrangement.**

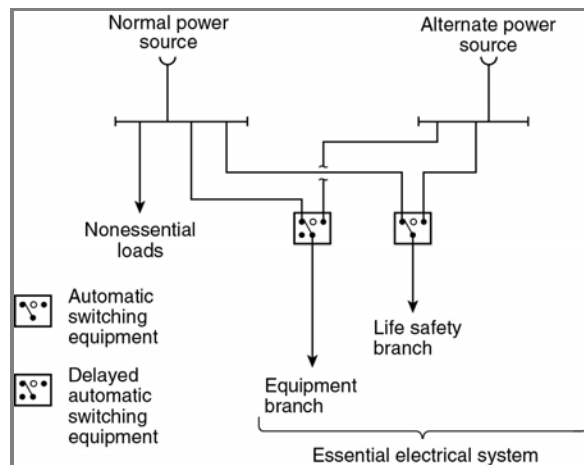

**Figure Informational Note Figure 517.42(B)(b) Type 2 Essential Electrical Systems (Nursing Home and Limited Health Care Facilities) — Minimum Requirement (150 kVA or Less) for Transfer Switch Arrangement.**

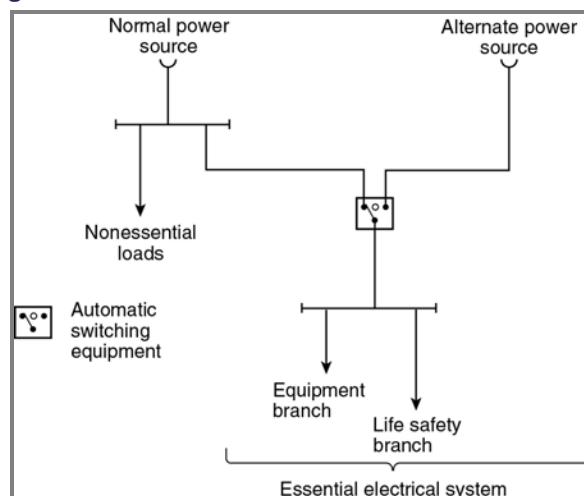
**(C) Capacity of System.**

The essential electrical system shall have capacity to meet the demand for the operation of all functions and equipment to be served by each branch at one time.



**(D) Separation from Other Circuits.**

The life safety branch and equipment branch shall be kept entirely independent of all other wiring and equipment. [99:6.7.6.3.1]

These circuits shall not enter the same raceways, boxes, or cabinets with other wiring except as follows:

- (1) In transfer switches
- (2) In exit or emergency luminaires supplied from two sources
- (3) In a common junction box attached to exit or emergency luminaires supplied from two sources

**(E) Receptacle Identification.**

The electrical receptacles or the cover plates for the electrical receptacles supplied from the life safety or equipment branches shall have a distinctive color or marking so as to be readily identifiable. [99:6.7.6.3.2]

Informational Note: If color is used to identify these receptacles, the same color should be used throughout the facility. [99:A.6.7.6.3.2]

**517.43–63 Automatic Connection to Life Safety and Equipment Branch.**

The life safety and equipment branches shall be installed and connected to the alternate source of power specified in 517.41 so that all functions specified herein for the life safety and equipment branches are automatically restored to operation within 10 seconds after interruption of the normal source. [99:6.7.6.4.1]

No functions other than those listed in 517.43(A) through (G) shall be connected to the life safety branch. [99:6.7.6.2.1.5(D)]

The life safety branch shall supply power as follows:

**(A) Illumination of Means of Egress.**

Illumination of means of egress as is necessary for corridors, passageways, stairways, landings, and exit doors and all ways of approach to exits. Switching arrangement to transfer patient corridor lighting from general illumination circuits shall be permitted if only one of two circuits can be selected and both circuits cannot be extinguished at the same time.

Informational Note: See NFPA 101-2021, *Life Safety Code*, Sections 7.8 and 7.9.

**(B) Exit Signs.**

Exit signs and exit directional signs.

Informational Note: See NFPA 101-2021, *Life Safety Code*, Section 7.10.

**(C) Alarm and Alerting Systems.**

Alarm and alerting systems, including the following:

- (1) Fire alarms

Informational Note No. 1: See NFPA 101-2021, *Life Safety Code*, Sections 9.6 and 18.3.4.

- (2) Alarms required for systems used for the piping of nonflammable medical gases

Informational Note No. 2: See NFPA 99-2021, *Health Care Facilities Code*, 6.7.5.1.2.5.

**(D) Communications Systems.**

Communications systems, where used for issuing instructions during emergency conditions. [99:6.7.5.1.2.4(3)]

**(E) Generator Set Location.**

Task illumination and select receptacles at the generator set location and essential electrical system transfer switch locations.

**(F) Elevators.**

Elevator cab lighting, control, communications, and signal systems. [99:6.7.5.1.2.4(5)]

**(G) AC Equipment for Nondelayed Automatic Connection.**

Generator accessories, including, but not limited to, the transfer fuel pump, electrically operated louvers, and other generator accessories essential for generator operation shall be arranged for automatic connection to the alternate power source. [99:6.7.6.2.1.6(C)]

**517.44–64 Connection to Equipment Branch.**

The equipment branch shall be installed and connected to the alternate power source such that equipment described in 517.35(A)(6) is automatically restored to operation at appropriate time-lag intervals following the energizing of the life safety and critical branches. [99:6.7.5.1.4.2(A)]

The equipment branch arrangement shall also provide for the additional connection of equipment listed in 517.44(B).

*Exception: For essential electrical systems under 150 kVA, deletion of the time-lag intervals feature for delayed automatic connection to the equipment branch shall be permitted.*

**(A) Delayed Automatic Connections to Equipment Branch.**

The following equipment shall be permitted to be connected to the equipment branch and shall be arranged for delayed automatic connection to the alternate power source:

(1) Task illumination and select receptacles in the following: [99:6.7.6.2.1.6(D)(1)]

(2) Patient care spaces [ 99: 6.7.6.2.1.6(D)(1)(a)]

(3) Medication preparation spaces

[ 99: 6.7.6.2.1.6(D)(1)(b)]

(4) Pharmacy dispensing space [ 99: 6.7.6.2.1.6(D)(1)(c)]

(5) Nurses' stations — unless adequately lighted by corridor luminaires [ 99: 6.7.6.2.1.6(D)(1)(d)]

(6) Supply, return, and exhaust ventilating systems for airborne infectious isolation rooms [99:6.7.6.2.1.6(D)(2)]

(7) Sump pumps and other equipment required to operate for the safety of major apparatus and associated control systems and alarms [99:6.7.6.2.1.6(D)(3)]

(8) Smoke control and stair pressurization systems [99:6.7.6.2.1.6(D)(4)]

(9) Kitchen hood supply or exhaust systems, or both, if required to operate during a fire in or under the hood [99:6.7.6.2.1.6(D)(5)]

(10) Nurse call systems [99:6.7.6.2.1.6(D)(6)]

**(B) Delayed-Automatic or Manual Connection to the Equipment Branch.**

The equipment specified in 517.44(B)(1) through (B)(4) shall be permitted to be connected to the equipment branch and shall be arranged for either delayed-automatic or manual connection to the alternate power source.

**(1) Heating Equipment to Provide Heating for General Patient Rooms.**

Heating of general patient rooms during disruption of the normal source shall not be required under any of the following conditions:

- (1) The outside design temperature is higher than  $-6.7^{\circ}\text{C}$  ( $20^{\circ}\text{F}$ ).
- (2) The outside design temperature is lower than  $-6.7^{\circ}\text{C}$  ( $20^{\circ}\text{F}$ ) and, where a selected room(s) is provided for the needs of all confined patients, then only such room(s) need be heated.
- (3) The facility is served by a dual source of normal power as described in 517.30(D), Informational Note.

Informational Note: The outside design temperature is based on the 97.5 percent design values, as shown in Chapter 24 of the ASHRAE *Handbook of Fundamentals* (2013).

**(2) Elevator Service.**

In instances where interruptions of power would result in elevators stopping between floors, throw-over facilities shall be provided to allow the temporary operation of any elevator for the release of passengers.

**(3) Optional Connections to the Equipment Branch.**

Additional illumination, receptacles, and equipment shall be permitted to be connected only to the equipment branch.

**(4) Multiple Systems.**

Where one switch serves multiple systems as permitted in 517.43, transfer for all loads shall be nondelayed automatic.

[99:6.7.6.2.1.6(E)]

Informational Note: For elevator cab lighting, control, and signal system requirements, see 517.43(G). [99:A.6.7.6.2.1.6(E)(2)]

**517.45–65 Essential Electrical Systems for Other Health Care Facilities.****(A) Essential Electrical Distribution.**

If required by the governing body, the essential electrical distribution system for Category 3 patient care spaces shall be comprised of an alternate power system capable of supplying a limited amount of lighting and power service for the orderly cessation of procedures during a time normal electrical service is interrupted.

Informational Note: See NFPA 99-2021, *Health Care Facilities Code*.

**(B) Electrical Life Support Equipment.**

Where electrical life support equipment is required, the essential electrical distribution system shall be as described in 517.29 through 517.30.

**(C) Category 1 Patient Care Spaces.**

Where Category 1 patient care spaces are present, the essential electrical distribution system shall be in accordance with 517.29 through 517.30.

**(D) Category 2 Patient Care Spaces.**

Where Category 2 patient care spaces are present, the essential electrical distribution system shall be in accordance with 517.40 through 517.45.

**(E) Power Systems.**

If required, alternate power sources acceptable to the governing body shall comply with the requirements of NFPA 99-2021, *Health Care Facilities Code*.

**Part IV. Inhalation Anesthetizing Locations**

Informational Note: See NFPA 99-2021, *Health Care Facilities Code*, for further information regarding safeguards for anesthetizing locations.

**517.60–70** Anesthetizing Location Classification.

Informational Note: If either of the anesthetizing locations in 517.60(A) or 517.60(B) is designated a wet procedure location, refer to 517.20.

**(A)** Hazardous (Classified) Location.**(1)** Use Location.

In a location where flammable anesthetics are employed, the entire area shall be considered to be a Class I, Division 1 location that extends upward to a level 1.52 m (5 ft) above the floor. The remaining volume up to the structural ceiling is considered to be above a hazardous (classified) location.

**(2)** Storage Location.

Any room or location in which flammable anesthetics or volatile flammable disinfecting agents are stored shall be considered to be a Class I, Division 1 location from floor to ceiling.

**(B)** Unclassified Location.

Any inhalation anesthetizing location designated for the exclusive use of nonflammable anesthetizing agents shall be considered to be an unclassified location.

**517.64–71** Wiring and Equipment.**(A)** Within Hazardous (Classified) Anesthetizing Locations.**(1)** Isolation.

Except as permitted in 517.160, each power circuit within, or partially within, a flammable anesthetizing location as referred to in 517.60 shall be isolated from any distribution system by the use of an isolated power system.

**(2)** Design and Installation.

Where an isolated power system is utilized, the isolated power equipment shall be listed as isolated power equipment, and the isolated power system shall be designed and installed in accordance with 517.160.

**(3)** Equipment Operating at More Than 10 Volts.

In hazardous (classified) locations referred to in 517.60, all fixed wiring and equipment and all portable equipment, including lamps and other utilization equipment, operating at more than 10 volts between conductors shall comply with the requirements of 501.1 through 501.25, and 501.100 through 501.150, and 501.30(B) and 501.30(B) for Class I, Division 1 locations. All such equipment shall be specifically approved for the hazardous atmospheres involved.

**(4)** Extent of Location.

Where a box, fitting, or enclosure is partially, but not entirely, within a hazardous (classified) location(s), the hazardous (classified) location(s) shall be considered to be extended to include the entire box, fitting, or enclosure.

**(5)** Receptacles and Attachment Plugs.

Receptacles and attachment plugs in a hazardous (classified) location(s) shall be listed for use in Class I, Group C hazardous (classified) locations and shall have provision for the connection of an equipment grounding conductor.

**(6)** Flexible Cord Type.

Flexible cords used in hazardous (classified) locations for connection to portable utilization equipment, including lamps operating at more than 8 volts between conductors, shall be of a type approved for extra-hard usage in accordance with Table 400.4 and shall include an additional equipment grounding conductor.

**(7)** Flexible Cord Storage.

A storage device for the flexible cord shall be provided and shall not subject the cord to bending at a radius of less than 75 mm (3 in.).

**(B)** Above Hazardous (Classified) Anesthetizing Locations.

**(1) Wiring Methods.**

Wiring above a hazardous (classified) location referred to in 517.60 shall be installed in rigid metal conduit, electrical metallic tubing, intermediate metal conduit, Type MI cable, or Type MC cable that employs a continuous, gas/vaportight metal sheath.

**(2) Equipment Enclosure.**

Installed equipment that may produce arcs, sparks, or particles of hot metal, such as lamps and lampholders for fixed lighting, cutouts, switches, generators, motors, or other equipment having make-and-break or sliding contacts, shall be of the totally enclosed type or be constructed so as to prevent escape of sparks or hot metal particles.

*Exception: Wall-mounted receptacles installed above the hazardous (classified) location in flammable anesthetizing locations shall not be required to be totally enclosed or have openings guarded or screened to prevent dispersion of particles.*

**(3) Luminaires.**

Surgical and other luminaires shall conform to 501.130(B).

*Exception No. 1: The surface temperature limitations set forth in 501.130(B)(1) shall not apply.*

*Exception No. 2: Integral or pendant switches that are located above and cannot be lowered into the hazardous (classified) location(s) shall not be required to be explosionproof.*

**(4) Seals.**

Listed seals shall be provided in conformance with 501.15, and 501.15(A)(4) shall apply to horizontal as well as to vertical boundaries of the defined hazardous (classified) locations.

**(5) Receptacles and Attachment Plugs.**

Receptacles and attachment plugs located above hazardous (classified) anesthetizing locations shall be listed for hospital use for services of prescribed voltage, frequency, rating, and number of conductors with provision for the connection of the equipment grounding conductor. This requirement shall apply to attachment plugs and receptacles of the 2-pole, 3-wire grounding type for single-phase, 120-volt, nominal, ac service.

**(6) 250-Volt Receptacles and Attachment Plugs Rated 50 and 60 Amperes.**

Receptacles and attachment plugs rated 250 volts, for connection of 50-ampere and 60-ampere ac medical equipment for use above hazardous (classified) locations, shall be arranged so that the 60-ampere receptacle will accept either the 50-ampere or the 60-ampere plug. Fifty-ampere receptacles shall be designed so as not to accept the 60-ampere attachment plug. The attachment plugs shall be of the 2-pole, 3-wire design with a third contact connecting to the insulated (green or green with yellow stripe) equipment grounding conductor of the electrical system.

**(C) Unclassified Anesthetizing Locations.****(1) Wiring Methods.**

Wiring serving unclassified locations, as defined in 517.60, shall be installed in a metal raceway system or cable assembly. The metal raceway system or cable armor or sheath assembly shall qualify as an equipment grounding conductor in accordance with 250.118. Type MC and Type MI cable shall have an outer metal armor, sheath, or sheath assembly that is identified as an equipment grounding conductor.

*Exception: Pendant receptacle installations that employ listed Type SJO or equivalent hard usage or extra-hard usage, flexible cords suspended not less than 1.8 m (6 ft) from the floor shall not be required to be installed in a metal raceway or cable assembly.*

**(2) Receptacles and Attachment Plugs.**

Receptacles and attachment plugs installed and used in unclassified locations shall be listed "hospital grade" for services of prescribed voltage, frequency, rating, and number of conductors with provision for connection of the equipment grounding conductor. This requirement shall apply to 2-pole, 3-wire grounding type for single-phase, 120-, 208-, or 240-volt, nominal, ac service.

**(3) 250-Volt Receptacles and Attachment Plugs Rated 50 Amperes and 60 Amperes.**

Receptacles and attachment plugs rated 250 volts, for connection of 50-ampere and 60-ampere ac medical equipment for use in unclassified locations, shall be arranged so that the 60-ampere receptacle will accept either the 50-ampere or the 60-ampere plug. Fifty-ampere receptacles shall be designed so as not to accept the 60-ampere attachment plug. The attachment plugs shall be of the 2-pole, 3-wire design with a third contact connecting to the insulated (green or green with yellow stripe) equipment grounding conductor of the electrical system.

**517.62–75 Grounding.**

In any anesthetizing area, all metal raceways and metal-sheathed cables and all normally non-current-carrying conductive portions of fixed electrical equipment shall be connected to an equipment grounding conductor. Grounding and bonding in Class I locations shall comply with 501.30.

*Exception: Equipment operating at not more than 10 volts between conductors shall not be required to be connected to an equipment grounding conductor.*

**517.63–76 Grounded Power Systems in Anesthetizing Locations.****(A) Battery-Powered Lighting Units.**

One or more battery-powered lighting units shall be provided and shall be permitted to be wired to the critical lighting circuit in the area and connected ahead of any local switches.

**(B) Branch-Circuit Wiring.**

Branch circuits supplying only listed, fixed, therapeutic and diagnostic equipment, permanently installed above the hazardous (classified) location and in unclassified locations, shall be permitted to be supplied from a normal grounded service, single- or three-phase system, provided the following apply:

- (1) Wiring for grounded and isolated circuits does not occupy the same raceway or cable.
- (2) All conductive surfaces of the equipment are connected to an equipment grounding conductor.
- (3) Equipment (except enclosed X-ray tubes and the leads to the tubes) is located at least 2.5 m (8 ft) above the floor or outside the anesthetizing location.
- (4) Switches for the grounded branch circuit are located outside the hazardous (classified) location.

*Exception: Sections 517.63(B)(3) and (B)(4) shall not apply in unclassified locations.*

**(C) Fixed Lighting Branch Circuits.**

Branch circuits supplying only fixed lighting shall be permitted to be supplied by a normal grounded service, provided the following apply:

- (1) Such luminaires are located at least 2.5 m (8 ft) above the floor.
- (2) All conductive surfaces of luminaires are connected to an equipment grounding conductor.
- (3) Wiring for circuits supplying power to luminaires does not occupy the same raceway or cable for circuits supplying isolated power.
- (4) Switches are wall-mounted and located above hazardous (classified) locations.

*Exception: Sections 517.63(C)(1) and (C)(4) shall not apply in unclassified locations.*

**(D) Remote-Control Stations.**

Wall-mounted remote-control stations for remote-control switches operating at 24 volts or less shall be permitted to be installed in any anesthetizing location.

**(E) Location of Isolated Power Systems.**

Where an isolated power system is utilized, the isolated power equipment shall be listed as isolated power equipment. Isolated power system equipment and its supply circuit shall be permitted to be located in an anesthetizing location, provided it is installed above a hazardous (classified) location or in an unclassified location.

**(F) Circuits in Anesthetizing Locations.**

Except as permitted above, each power circuit within, or partially within, a flammable anesthetizing location as referred to in 517.60 shall be isolated from any distribution system supplying other-than-anesthetizing locations.

**517.64–68 Low-Voltage Equipment and Instruments.****(A) Equipment Requirements.**

Low-voltage equipment that is frequently in contact with the bodies of persons or has exposed current-carrying elements shall comply with one of the following:

- (1) Operate on an electrical potential of 10 volts or less
- (2) Be approved as intrinsically safe or double-insulated equipment
- (3) Be moisture resistant

**(B) Power Supplies.**

Power shall be supplied to low-voltage equipment from one of the following:

- (1) An individual portable isolating transformer (autotransformers shall not be used) connected to an isolated power circuit receptacle by means of an appropriate cord and attachment plug
- (2) A common low-voltage isolating transformer installed in an unclassified location
- (3) Individual dry-cell batteries
- (4) Common batteries made up of storage cells located in an unclassified location

**(C) Isolated Circuits.**

Isolating-type transformers for supplying low-voltage circuits shall have both of the following:

- (1) Approved means for insulating the secondary circuit from the primary circuit
- (2) The core and case connected to an equipment grounding conductor

**(D) Controls.**

Resistance or impedance devices shall be permitted to control low-voltage equipment but shall not be used to limit the maximum available voltage to the equipment.

**(E) Battery-Powered Appliances.**

Battery-powered appliances shall not be capable of being charged while in operation unless their charging circuitry incorporates an integral isolating-type transformer.

**(F) Receptacles or Attachment Plugs.**

Any receptacle or attachment plug used on low-voltage circuits shall be of a type that does not permit interchangeable connection with circuits of higher voltage.

Informational Note: Any interruption of the circuit, even circuits as low as 10 volts, either by any switch or loose or defective connections anywhere in the circuit, may produce a spark that is sufficient to ignite flammable anesthetic agents.

**Part V. Diagnostic Imaging and Treatment Equipment**

**517.70–80** Applicability.

Nothing in this part shall be construed as specifying safeguards against possible radiation or magnetic fields.

Informational Note No. 1: Radiation safety and performance requirements of several classes of X-ray equipment are regulated under Public Law 90-602 and are enforced by the Department of Health and Human Services.

Informational Note No. 2: Information on radiation protection by the National Council on Radiation Protection and Measurements is published as *Reports of the National Council on Radiation Protection and Measurement*. These reports are obtainable from NCRP Publications, P.O. Box 30175, Washington, DC 20014.

Informational Note No. 3: Diagnostic imaging equipment includes, but is not limited to, the following:

- (1) General radiographic (X-ray) equipment (mobile and fixed)
- (2) General fluoroscopic equipment (mobile and fixed)
- (3) Interventional equipment (mobile and fixed)
- (4) Bone mineral density equipment
- (5) Dental equipment
- (6) Computerized tomography (CT) equipment
- (7) Positron emission tomography (PET) equipment
- (8) Nuclear medicine equipment
- (9) Mammography equipment
- (10) Magnetic resonance (MR) equipment
- (11) Diagnostic ultrasound equipment
- (12) Electrocardiogram equipment

Informational Note No. 4: Treatment equipment includes, but is not limited to, the following:

- (1) Linear accelerators
- (2) Gamma knife
- (3) Cyber knife
- (4) Proton therapy
- (5) Tomotherapy

**517.74–81** Connection to Supply Circuit.**(A)** Fixed and Stationary Diagnostic Imaging and Treatment Equipment.

Fixed and stationary diagnostic imaging and treatment equipment shall be connected to the power supply by means of a wiring method complying with applicable requirements of Chapters 1 through 4 of this Code, as modified by this article.

*Exception: Equipment properly supplied by a branch circuit rated at not over 30 amperes shall be permitted to be supplied through a suitable attachment plug and hard-service cable or cord.*

**(B)** Portable, Mobile, and Transportable Diagnostic Imaging and Treatment Equipment.

Individual branch circuits shall not be required for portable, mobile, and transportable medical diagnostic imaging and treatment equipment requiring a capacity of not over 60 amperes.

**(C)** Over 1000-Volt Supply.

Circuits and equipment operated on a supply circuit of over 1000 volts shall comply with Parts I through IV of Article 490.

**517.72–82** Disconnecting Means.



**(A) Capacity.**

A disconnecting means rated for at least 50 percent of the input required for the momentary rating or 100 percent of the input required for the long-time rating of the diagnostic imaging and treatment equipment, whichever is greater, shall be provided in the supply circuit.

**(B) Location.**

The disconnecting means shall be operable from a location readily accessible from the control location.

**(C) Portable, Mobile, and Transportable Diagnostic Imaging and Treatment Equipment.**

For equipment connected to a 120-volt branch circuit of 30 amperes or less, a grounding-type attachment plug and receptacle of proper rating shall be permitted to serve as a disconnecting means.

**517.73–85** Rating of Supply Conductors and Overcurrent Protection.**(A) Branch Circuits.**

The ampacity of supply branch-circuit conductors and the current rating of overcurrent protective devices shall not be less than 50 percent of the momentary rating or 100 percent of the long-time rating, whichever is greater.

**(B) Feeders.**

The ampacity of supply feeders and the current rating of overcurrent protective devices supplying two or more branch circuits supplying diagnostic imaging and treatment equipment shall not be less than 50 percent of the momentary demand rating of the largest unit, plus 10 percent of the momentary demand rating of the next largest unit, plus 5 percent of the momentary demand rating of each additional unit.

Informational Note No. 1: The minimum conductor size for branch and feeder circuits is also governed by voltage regulation requirements. For a specific installation, the manufacturer usually specifies minimum distribution transformer and conductor sizes, rating of disconnecting means, and overcurrent protection.

Informational Note No. 2: The ampacity of the branch-circuit conductors and the ratings of disconnecting means and overcurrent protection for diagnostic imaging and treatment equipment are usually designated by the manufacturer for the specific installation.

**517.74–86** Control Circuit Conductors.**(A) Number of Conductors in Raceway.**

The number of control circuit conductors installed in a raceway shall be determined in accordance with 300.17.

**(B) Minimum Size of Conductors.**

Size 18 AWG or 16 AWG fixture wires in accordance with 725.49 and flexible cords shall be permitted for the control and operating circuits of diagnostic imaging and treatment equipment and auxiliary equipment where protected by not larger than 20-ampere overcurrent devices.

**517.76–90** Transformers and Capacitors.

Transformers and capacitors that are part of diagnostic imaging and treatment equipment shall not be required to comply with Parts I and II of Articles 450 and 460.

Capacitors shall be mounted within enclosures of insulating material or grounded metal.

**517.77–92** Installation of Cables with Grounded Shields.

Cables with grounded shields shall be permitted to be installed in cable trays or cable troughs along with control and power supply conductors without the need for barriers to separate the wiring.

**517.78–94** Guarding and Grounding.

**(A) High-Voltage Parts.**

All high-voltage parts shall be mounted within grounded enclosures. The connection from the high-voltage equipment to other high-voltage components shall be made with high-voltage shielded cables.

**(B) Low-Voltage Cables.**

Low-voltage cables connecting to oil-filled units that are not completely sealed, such as transformers, condensers, oil coolers, and high-voltage switches, shall have insulation of the oil-resistant type.

**(C) Non-Current-Carrying Metal Parts.**

Non-current-carrying metal parts of diagnostic imaging and treatment equipment (e.g., controls, tables, transformer tanks, shielded cables) shall be connected to an equipment grounding conductor in accordance with Part VII of Article 250, as modified by 517.13(A) and (B).

**Part VI. Communications, Signaling Systems, Data Systems, Fire Alarm Systems, and Systems Less Than 120 Volts, Nominal****517.80–100 \_ Patient Care Spaces.**

Equivalent insulation and isolation to that required for the electrical distribution systems in patient care areas shall be provided for communications, signaling systems, data system circuits, fire alarm systems, and systems less than 120 volts, nominal.

Class 2 and Class 3 signaling and communications systems, Class 2 circuits that transmit power and data to a powered device, and power-limited fire alarm systems shall not be required to comply with the grounding requirements of 517.13, to comply with the mechanical protection requirements of 517.31(C)(3)(5), or to be enclosed in raceways, unless otherwise specified by Chapters 7 or 8.

Secondary circuits of transformer-powered communications or signaling systems shall not be required to be enclosed in raceways unless otherwise specified by Chapters 7 or 8. [99:6.7.2.2.7]

Informational Note: See ANSI/NEMA C137.3-2017, *American National Standard for Lighting Systems — Minimum Requirements for Installation of Energy Efficient Power over Ethernet (PoE) Lighting Systems*, for information on installation of cables for PoE lighting systems.

**517.84–101 Other-Than-Patient-Care Spaces.**

In other-than-patient-care spaces, installations shall be in accordance with other parts of this Code.

**517.82–102 Signal Transmission Between Appliances.****(A) General.**

Permanently installed signal cabling from an appliance in a patient location to remote appliances shall employ a signal transmission system that prevents hazardous grounding interconnection of the appliances.

Informational Note: See 517.13(A) for additional grounding requirements in patient care spaces.

**(B) Common Signal Grounding Wire.**

Common signal grounding wires (i.e., the chassis ground for single-ended transmission) shall be permitted to be used between appliances all located within the patient care vicinity, provided the appliances are served from the same reference grounding point.

**Part VII. Isolated Power Systems****517.160–110 Isolated Power Systems.****(A) Installations.**

**(1) Isolated Power Circuits.**

Each isolated power circuit shall be controlled by a switch or circuit breaker that has a disconnecting pole in each isolated circuit conductor to simultaneously disconnect all power. Such isolation shall be accomplished by means of one or more isolation transformers, by means of generator sets, or by means of electrically isolated batteries. Conductors of isolated power circuits shall not be installed in cables, raceways, or other enclosures containing conductors of another system.

**(2) Circuit Characteristics.**

Circuits supplying primaries of isolating transformers shall operate at not more than 600 volts between conductors and shall be provided with proper overcurrent protection. The secondary voltage of such transformers shall not exceed 600 volts between conductors of each circuit. All circuits supplied from such secondaries shall be ungrounded and shall have an approved overcurrent device of proper ratings in each conductor. Circuits supplied directly from batteries or from motor generator sets shall be ungrounded and shall be protected against overcurrent in the same manner as transformer-fed secondary circuits. If an electrostatic shield is present, it shall be connected to the reference grounding point.

**(3) Equipment Location.**

The isolating transformers, motor generator sets, batteries and battery chargers, and associated primary or secondary overcurrent devices shall not be installed in hazardous (classified) locations. The isolated secondary circuit wiring extending into a hazardous anesthetizing location shall be installed in accordance with 501.10.

**(4) Isolation Transformers.**

An isolation transformer shall not serve more than one operating room except as covered in 517.160(A)(4)(a) and (A)(4)(b).

For purposes of this section, anesthetic induction rooms are considered part of the operating room or rooms served by the induction rooms.

(a) *Induction Rooms.* Where an induction room serves more than one operating room, the isolated circuits of the induction room shall be permitted to be supplied from the isolation transformer of any one of the operating rooms served by that induction room.

(b) *Higher Voltages.* Isolation transformers shall be permitted to serve single receptacles in several patient areas where the following apply:

- (3) The receptacles are reserved for supplying power to equipment requiring 150 volts or higher, such as portable X-ray units.
- (4) The receptacles and mating plugs are not interchangeable with the receptacles on the local isolated power system.

**(5) Conductor Identification.**

The isolated circuit conductors shall be identified as follows:

- (1) Isolated Conductor No. 1 — Orange with at least one distinctive colored stripe other than white, green, or gray along the entire length of the conductor
- (2) Isolated Conductor No. 2 — Brown with at least one distinctive colored stripe other than white, green, or gray along the entire length of the conductor

For 3-phase systems, the third conductor shall be identified as yellow with at least one distinctive colored stripe other than white, green, or gray along the entire length of the conductor. Where isolated circuit conductors supply 125-volt, single-phase, 15- and 20-ampere receptacles, the striped orange conductor(s) shall be connected to the terminal(s) on the receptacles that are identified in accordance with 200.10(B) for connection to the grounded circuit conductor.

**(6) Wire-Pulling Compounds.**

Wire-pulling compounds that increase the dielectric constant shall not be used on the secondary conductors of the isolated power supply.

Informational Note No. 1: It is desirable to limit the size of the isolation transformer to 10 kVA or less and to use conductor insulation with low leakage to meet impedance requirements.

Informational Note No. 2: Minimizing the length of branch-circuit conductors and using conductor insulations with a dielectric constant less than 3.5 and insulation resistance constant greater than 6100 megohm-meters (20,000 megohm-feet) at 16°C (60°F) reduces leakage from line to ground, reducing the hazard current.

**(B) Line Isolation Monitor.****(1) Characteristics.**

In addition to the usual control and overcurrent protective devices, each isolated power system shall be provided with a listed continually operating line isolation monitor that indicates total hazard current. The monitor shall be designed such that a green signal lamp, conspicuously visible to persons in each area served by the isolated power system, remains lighted when the system is adequately isolated from ground. An adjacent red signal lamp and an audible warning signal (remote if desired) shall be energized when the total hazard current (consisting of possible resistive and capacitive leakage currents) from either isolated conductor to ground reaches a threshold value of 5 mA under nominal line voltage conditions. The line monitor shall not alarm for a fault hazard of less than 3.7 mA or for a total hazard current of less than 5 mA.

*Exception: A system shall be permitted to be designed to operate at a lower threshold value of total hazard current. A line isolation monitor for such a system shall be permitted to be approved, with the provision that the fault hazard current shall be permitted to be reduced but not to less than 35 percent of the corresponding threshold value of the total hazard current, and the monitor hazard current is to be correspondingly reduced to not more than 50 percent of the alarm threshold value of the total hazard current.*

**(2) Impedance.**

The line isolation monitor shall be designed to have sufficient internal impedance such that, when properly connected to the isolated system, the maximum internal current that can flow through the line isolation monitor, when any point of the isolated system is grounded, shall be 1 mA.

*Exception: The line isolation monitor shall be permitted to be of the low-impedance type such that the current through the line isolation monitor, when any point of the isolated system is grounded, will not exceed twice the alarm threshold value for a period not exceeding 5 milliseconds.*

Informational Note: Reduction of the monitor hazard current, provided this reduction results in an increased "not alarm" threshold value for the fault hazard current, will increase circuit capacity.

**(3) Ammeter.**

An ammeter calibrated in the total hazard current of the system (contribution of the fault hazard current plus monitor hazard current) shall be mounted in a plainly visible place on the line isolation monitor with the "alarm on" zone at approximately the center of the scale.

*Exception: The line isolation monitor shall be permitted to be a composite unit, with a sensing section cabled to a separate display panel section on which the alarm or test functions are located.*

Informational Note: It is desirable to locate the ammeter so that it is conspicuously visible to persons in the anesthetizing location.

**Additional Proposed Changes**

<u>File Name</u>	<u>Description</u>	<u>Approved</u>
.1626359038126		

## Statement of Problem and Substantiation for Public Comment

PI 3333 in the First Draft meeting asked CMP 15 to review the numbering system in the Articles as related to the Style Manual. This review was never fully vetted by the panel. This second draft proposal is a recommendation to NFPA staff to review the numbering system used in 517 and provide space for insertion of new language without the panel having to make wholesale numbering changes.

### 2023 NEC 2nd Draft Numbering Changes to Article 517

#### Part 1. General (Number Ranges 517.1 - 517.9)

Current Number: To Become: New Number:

517.1	No Change	
517.4	No Change	
517.6	No Change	

#### Part II. Wiring And Protection Number Range 517.10 - 517.39

Current Number: To Become: New Number:

517.10	No Change	
517.12	No Change	
517.13	No Change	
517.14	No Change	
517.16	No Change	
517.17	517.21	
517.18	517.24	
517.19	517.25	
517.20	517.29	
517.21	517.30	
517.22	517.35	

#### Part III. Essential Electrical Systems (Number Range 517.40 - 517.69)

Current Number: To Become: New Number:

517.25	517.40	
517.26	517.42	
517.29	517.43	
517.30	517.45	
517.31	517.46	
517.32	517.47	
517.33	517.50	
517.34	517.51	
517.35	517.52	
517.40	517.60	
517.41	517.61	
517.42	517.62	
517.43	517.63	
517.44	517.64	
517.45	517.65	

#### Part VI. Anesthetizing Location Classification. (Number Range 517.70 - 517.79)

Current Number: To Become: New Number:

517.60	517.70	
517.61	517.71	
517.62	517.75	
517.63	517.76	
517.64	517.68	

#### Part V. Diagnostic Imaging and Treatment Equipment. (Number Range 517.80 - 517.99)

Current Number: To Become: New Number:

517.70	517.80	
517.71	517.81	
517.72	517.82	

517.73	517.85
517.74	517.86
517.76	517.90
517.77	517.92
517.78	517.94

Part V. Communications, Signalling Systems, Data Systems, Fire Alarm Systems, and Systems Less Than 120 Volts, Nominal. (Number Range 517.100 - 517.109)

Current Number: To Become: New Number:

517.80	517.100
517.81	517.101
517.82	517.102

Part VI. Isolated Power Systems. (Number Range 517.110 - 517.120)

Current Number: To Become: New Number:

517.160	517.110
---------	---------

### Related Item

- PI 3333

## Submitter Information Verification

**Submitter Full Name:** Gary Beckstrand

**Organization:** Utah Electrical JATC

**Street Address:**

**City:**

**State:**

**Zip:**

**Submittal Date:** Thu Jul 15 10:18:42 EDT 2021

**Committee:** NEC-P15

## Committee Statement

**Committee Action:** Rejected but held

**Resolution:**

The TG agrees in concept, but all references need to be updated as well. This needs to be carefully reviewed.

### Copyright Assignment

I, Gary Beckstrand, hereby irrevocably grant and assign to the National Fire Protection Association (NFPA) all and full rights in copyright in this Public Comment (including both the Proposed Change and the Statement of Problem and Substantiation). I understand and intend that I acquire no rights, including rights as a joint author, in any publication of the NFPA in which this Public Comment in this or another similar or derivative form is used. I hereby warrant that I am the author of this Public Comment and that I have full power and authority to enter into this copyright assignment.

By checking this box I affirm that I am Gary Beckstrand, and I agree to be legally bound by the above Copyright Assignment and the terms and conditions contained therein. I understand and intend that, by checking this box, I am creating an electronic signature that will, upon my submission of this form, have the same legal force and effect as a handwritten signature



## Public Input No. 2132-NFPA 70-2023 [ New Section after 517.1 ]

### **517.4 Services and Feeders**

One source, or sets of sources shall be sized to supply the entire healthcare facility electrical load and shall be permitted to be located on-site or off-site. The source(s) shall be one of the following:

- a. An off-site public utility source with service to the site
- b. On-site resources (PV's, Batteries, Fuel Cell(s) etc.)
- c. A combination of both

Informational Note: Healthcare facility electrical loads shall be determined in accordance with Article 220.

### **Statement of Problem and Substantiation for Public Input**

The sizing requirements of service and feeders is included in Article 220, however the concept of utilizing on-site power resources (Sources and stored energy power supply systems) appears to be a newer concept that has not been addressed directly by code. This statement clarifies the minimum requirements for the resources that feed the entire site. Related sections 517.30(A) and 517.41(A) provide minimum requirements for the sizing of resources that feed the Essential Electrical System. We recommend that this new language be added to ensure that adequate resources are provided for both the entire site electrical requirements and for the Essential Electrical System as required in 517.3(A) and 517.41(A) for the Essential Electrical System.

### **Related Public Inputs for This Document**

<u>Related Input</u>	<u>Relationship</u>
<u>Public Input No. 1968-NFPA 70-2023 [Section No. 517.30]</u>	
<u>Public Input No. 2150-NFPA 70-2023 [Section No. 517.41]</u>	
<u>Public Input No. 1968-NFPA 70-2023 [Section No. 517.30]</u>	
<u>Public Input No. 2150-NFPA 70-2023 [Section No. 517.41]</u>	

### **Submitter Information Verification**

**Submitter Full Name:** Jamie Schnick  
**Organization:** OSHPD/HCAI  
**Affiliation:** Office of Hospitals Planning and Development/Department of Healthcare Access and Information - California  
**Street Address:**  
**City:**  
**State:**  
**Zip:**  
**Submittal Date:** Sat Aug 12 22:07:42 EDT 2023  
**Committee:** NEC-P15



## Public Input No. 2515-NFPA 70-2023 [ New Section after 517.1 ]

### 517.2 Electrical Systems and Sources

(A) Health care buildings shall contain a minimum of two distribution systems. One distribution system shall be the Essential Electrical System as described in Section III. The other distribution system shall serve non-essential loads.

(B) Hospital electrical systems shall have two or more independent sources or sets of sources. One source or set of sources shall be located on-site, and shall be sized to supply the entire EES. The other independent source or set of sources shall be sized to supply the entire EES and shall be permitted to be located on-site or off-site. Additional sources other than the first two independent sources shall be permitted.

(C) Power sources for health care buildings shall be permitted to be any of those specified in 517.2 (C) (1) through (C) (5).

(1) Off-site ("utility") source.

(2) Generating Units

(3) Fuel Cell Systems that comply with Parts I through VII of Article 692 for 1000 volts or less and Part VIII for over 1000 volts.

(4) Energy Storage Systems

(5) Health Care Microgrid.

(D) Location of Source Equipment

(1) Source Equipment shall be located to minimize interruptions caused by manmade causes and natural forces common to the area (e.g. storms, floods), hazards created by adjoining structures or activities, or internal wiring and equipment failures.

(E) Capacity of Systems. The systems shall have the capacity and rating to meet the maximum actual demand to be produced by the connected load of the system served. Demand calculations for sizing of the systems shall be based on any of the following:

(1) Prudent demand factors and historical data.

(2) Connected load.

(3) Feeder Calculations.

(4) Any combination of the above.

The sizing requirements in 700.4 and 701.4 shall not apply to health care sources.

(F) Feeders. Feeders to the essential electrical system shall be located to provide physical separation of the feeders to prevent simultaneous interruption. [99:6.2.4.3]

### Additional Proposed Changes

<u>File Name</u>	<u>Description</u>	<u>Approved</u>
IMG_2424.jpg	Figure 517.2 Health Care Electrical Sources and Distribution Systems	

### Statement of Problem and Substantiation for Public Input

Today, we have requirements in 517.30 that describe the sources for the Essential Electrical System. We have no requirement for the non-essential loads. We need to make it clear how service should be provided to that part of the electrical system.



## Related Public Inputs for This Document

<u>Related Input</u>	<u>Relationship</u>
<a href="#">Public Input No. 2792-NFPA 70-2023 [Section No. 517.30(B)]</a>	
<a href="#">Public Input No. 3549-NFPA 70-2023 [Section No. 517.30]</a>	
<a href="#">Public Input No. 3553-NFPA 70-2023 [Section No. 517.31(B) [Excluding any Sub-Sections]]</a>	
<a href="#">Public Input No. 3593-NFPA 70-2023 [Section No. 517.31(D)]</a>	
<a href="#">Public Input No. 3601-NFPA 70-2023 [Section No. 517.42(C)]</a>	

## Submitter Information Verification

**Submitter Full Name:** Walter Vernon

**Organization:** Mazzetti

**Street Address:**

**City:**

**State:**

**Zip:**

**Submittal Date:** Fri Aug 18 18:03:07 EDT 2023

**Committee:** NEC-P15

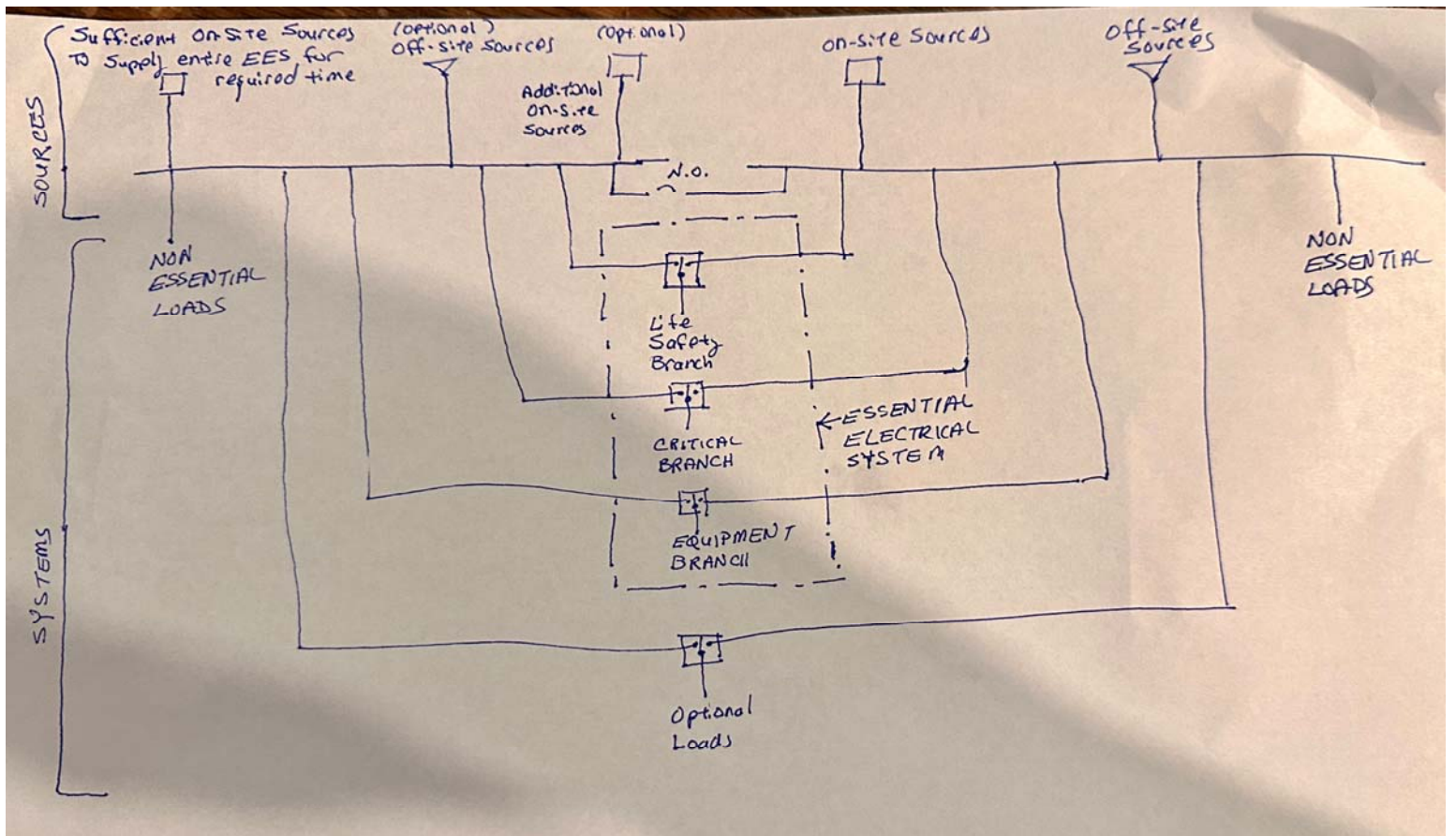



## Public Input No. 2783-NFPA 70-2023 [ Section No. 517.1 ]

### 517.1 Scope.

This article applies to electrical construction and installation criteria in health care facilities that provide services to human beings.

The requirements of this article shall specify the installation criteria and wiring methods that ensure reliable electrical service to the electrical loads in the health care facility and to minimize electrical hazards by the maintenance of adequately low potential differences only between exposed conductive surfaces that are likely to become energized and could be contacted by a patient.

Informational Note No. 1: In a health care facility, it is difficult to prevent the occurrence of a conductive or capacitive path from the patient's body to some grounded object, because that path might be established accidentally or through instrumentation directly connected to the patient. Other electrically conductive surfaces that might make an additional contact with the patient, or instruments that might be connected to the patient, then become possible sources of electric currents that can traverse the patient's body. The hazard is increased as more apparatus is associated with the patient, therefore more intensive precautions are needed. Control of electric shock hazard requires the limitation of electric current that might flow in an electrical circuit involving the patient's body by raising the resistance of the conductive circuit that includes the patient, or by insulating exposed conductive surfaces that might become energized, in addition to reducing the potential difference that can appear between exposed conductive surfaces in the patient care vicinity, or by combinations of these methods. A special problem is presented by the patient with an externalized direct conductive path to the heart muscle. The patient could be electrocuted at current levels so low that additional protection in the design of appliances, insulation of the catheter, and control of medical practice is required.

The requirements in Parts II and III not only apply to single-function buildings but are also intended to be individually applied to their respective forms of occupancy within a multifunction building [e.g., a doctor's examining room located within a limited care facility would be required to meet 517.10(A)].

Informational Note No. 2 : For information concerning performance, maintenance, and testing criteria, refer to the appropriate health care facilities documents.

Informational Note No. 3: Text that is followed by a reference in brackets has been extracted from NFPA 99-2021, *Health Care Facilities Code*, or NFPA 101-2021, *Life Safety Code*. Only editorial changes were made to the extracted text to make it consistent with this *Code*.

## Statement of Problem and Substantiation for Public Input

This is a minor suggestion in order to widen the purpose of the chapter to more than just wiring. A big emphasis of this chapter is to ensure reliable electrical service and not simply minimize risk from potential differences.

## Submitter Information Verification

**Submitter Full Name:** Walter Vernon

**Organization:** Mazzetti

**Street Address:**

**City:**

**State:**

**Zip:**

**Submittal Date:** Thu Aug 24 21:00:02 EDT 2023

**Committee:** NEC-P15



**Public Input No. 2906-NFPA 70-2023 [ Section No. 517.1 ]**

A large, empty rectangular box with a thin border, intended for public input or comments.

**517.1 Scope.**

This article applies to electrical construction and installation criteria in health care facilities that provide services to human beings.

The requirements of this article shall specify the installation criteria and wiring methods that minimize electrical hazards by the maintenance of adequately low potential differences only between exposed conductive surfaces that are likely to become energized and could be contacted by a patient.

Informational Note No. 1: In a health care facility, it is difficult to prevent the occurrence of a conductive or capacitive path from the patient's body to some grounded object, because that path might be established accidentally or through instrumentation directly connected to the patient. Other electrically conductive surfaces that might make an additional contact with the patient, or instruments that might be connected to the patient, then become possible sources of electric currents that can traverse the patient's body. The hazard is increased as more apparatus is associated with the patient, therefore more intensive precautions are needed. Control of electric shock hazard requires the limitation of electric current that might flow in an electrical circuit involving the patient's body by raising the resistance of the conductive circuit that includes the patient, or by insulating exposed conductive surfaces that might become energized, in addition to reducing the potential difference that can appear between exposed conductive surfaces in the patient care vicinity, or by combinations of these methods. A special problem is presented by the patient with an externalized direct conductive path to the heart muscle. The patient could be electrocuted at current levels so low that additional protection in the design of appliances, insulation of the catheter, and control of medical practice is required.

The requirements in Parts II and III not only apply to single-function buildings but are also intended to be individually applied to their respective forms of occupancy within a multifunction building [e.g., a doctor's examining room located within a limited care facility would be required to meet 517.10(A)].

Informational Note No. 2 : For information concerning performance, maintenance, and testing criteria, refer to the appropriate health care facilities documents.

Informational Note No. 3: Text that is followed by a reference in brackets has been extracted from NFPA 99-2021, *Health Care Facilities Code*, or NFPA 101-2021, *Life Safety Code*. Only editorial changes were made to the extracted text to make it consistent with this *Code*.

Informational Note No. 4: Definitions. Each of the following terms has a definition in Article 100 that is unique to its use in Article 517:

Alternate power source

Ambulatory health care occupancy

Anesthetizing location

Battery-powered lighting units

Critical branch

Electrical life support equipment

Equipment branch

Essential electrical system

Exposed conductive surfaces

Flammable anesthetics

Flammable anesthetizing location

Hazard current

- Fault hazard current

- Monitor hazard current

- Total hazard current

Health care facility's governing body

Health care microgrid

Invasive procedure

Isolated power system

Isolation transformer

Life safety branch

Line isolation monitor

Long-time rating (standby power)

Momentary rating (maximum power)

Nurses' station

Patient care–related electrical equipment

Patient care space category

- Category 1 space

- Category 2 space

- Category 3 space

- Category 4 space

Patient care vicinity

Patient equipment grounding point

Psychiatric hospital

Reference grounding point

Relative analgesia

Selected receptacles

Space

Task illumination

Wet procedure location

-



## Statement of Problem and Substantiation for Public Input

The change to locations of definitions in the 2023 Edition of the NEC was controversial for many people because it reduced usability. Even though other NFPA standards use this structure and was stated as a justification to the change in the 'NEC Style Manual' (some NFPA codes and standards include definitions within articles \*), many believe this relocation leads to confusion among users, especially for those articles that are specialty topics – i.e., the articles in Chapters 5 through 8. There are over 37 pages of definitions in Article 100 to search through.

Common language terms often have more specific meanings within an article. One only needs to look at the multiple definitions for 'Portable Equipment' to get a sense of this issue. Another example is 'Bundled' – specific to Article 520 – while 'Cable Bundle' is defined in Article 100 differently but not article specific. In Article 517, 'Space' has a specific definition (extracted from NFPA 99), but without a proximate reference within Article 517, the importance of this definition may be lost. The Annex A Explanatory Material in NFPA 99 – analogous to Informational notes in NFPA 70 – makes multiple references to definitions.

Under the current structure, important specialty definitions are lost in the sheer size of the Article 100 list. The usability of the NEC has been damaged, and users of specialty articles in Chapters 5 through 8 need help with this structure.

To restore the usability of the NEC, what is needed is a way to clearly identify and point to specialty definitions in a standardized location within articles, while leaving the definitions themselves in Article 100. NFPA Link and the NEC Handbook add this information as Enhanced Content. Additionally, this "definition identification" model has proven its usability in other codes such as NFPA 1, NFPA 99, and NFPA 101. The NEC deserves no less.

\* Example: NFPA 101 – Section 6.1.2.1 'Assembly Occupancy' is one of several definitions in an Article; and in this instance it is duplicated from 3.3.205.2]. In fact, there are multiple definitions throughout NFPA 101.

## Submitter Information Verification

**Submitter Full Name:** Mitchell Hefter

**Organization:** Signify

**Street Address:**

**City:**

**State:**

**Zip:**

**Submittal Date:** Sat Aug 26 15:45:42 EDT 2023

**Committee:** NEC-P15



## Public Input No. 4481-NFPA 70-2023 [ Section No. 517.1 ]

### 517.1 Scope.

This article applies to electrical construction and installation criteria in health care facilities that provide services to human beings.

The requirements of this article shall specify the installation criteria and wiring methods that minimize electrical hazards by the maintenance of adequately low potential differences only between exposed conductive surfaces that are likely to become energized and could be contacted by a patient.

Informational Note No. 1: In a health care facility, it is difficult to prevent the occurrence of a conductive or capacitive path from the patient's body to some grounded object, because that path might be established accidentally or through instrumentation directly connected to the patient. Other electrically conductive surfaces that might make an additional contact with the patient, or instruments that might be connected to the patient, then become possible sources of electric currents that can traverse the patient's body. The hazard is increased as more apparatus is associated with the patient, therefore more intensive precautions are needed. Control of electric shock hazard requires the limitation of electric current that might flow in an electrical circuit involving the patient's body by raising the resistance of the conductive circuit that includes the patient, or by insulating exposed conductive surfaces that might become energized, in addition to reducing the potential difference that can appear between exposed conductive surfaces in the patient care vicinity, or by combinations of these methods. A special problem is presented by the patient with an externalized direct conductive path to the heart muscle. The patient could be electrocuted at current levels so low that additional protection in the design of appliances, insulation of the catheter, and control of medical practice is required.

The requirements in Parts II and III not only apply to single-function buildings but are also intended to be individually applied to their respective forms of occupancy within a multifunction building [e.g., a doctor's examining room located within a limited care facility would be required to meet 517.10(A)].

Informational Note No. 2 : For information concerning performance, maintenance, and testing criteria, refer to the appropriate health care facilities documents.

Informational Note No. 3: Text that is followed by a reference in brackets has been extracted from NFPA 99-2021, *Health Care Facilities Code*, or NFPA 101-2021, *Life Safety Code*. Only editorial changes were made to the extracted text to make it consistent with this *Code*.

### **517.2 Service Source Identification**

**Incoming utility service that is the primary source of power to the facilities covered in this article shall be identified and marked on the service switchgear.**

## Statement of Problem and Substantiation for Public Input

A great deal of the interior power chain in healthcare facilities is devoted to assuring some level of power availability when power from the merchant utility is not present. The more reliable the incoming service, the better; though minimum IT&M requirements set by conformance agencies must be met.

For illustrative purposes assume the following -- a classical main-tie-main incoming service switchgear lineup. While it is unlikely that identification of the source(s) is not present (an NEC violation in itself); conformance to this proposal has come practical effect:

1. Have changes in the upstream distribution system changed availability expectations?
2. If two independent utility sources were assured upon original commissioning, do they remain optimally independent?
3. Except where service conductors enter a switchgear room, geographic independence of two service conductors to the furthest extent possible should be the first choice,

Periodic communication between the healthcare facility management and utility distribution engineers about the condition of the upstream network. Simply having a labeled incoming circuit sets the agenda for discussion about reliability.

See "Operational Resilience of Hospital Power Systems in the Digital Age" IEEE Transactions on Industry Applications, Giuseppe Parise, et. al, 2021

<https://ieeexplore.ieee.org/document/9237173>

<https://standardsmichigan.com/resilience-of-hospital-power-systems-in-the-digital-age/>

Also: "If You Can Measure It, You Can Improve It", Journal of Healthcare Management, Michael A. Anthony, January 2023

<https://www.researchgate.net/publication>

[/373496980\\_Position\\_If\\_You\\_Can\\_Measure\\_It\\_You\\_Can\\_Improve\\_It\\_Lord\\_Kelvin](https://www.researchgate.net/publication/373496980_Position_If_You_Can_Measure_It_You_Can_Improve_It_Lord_Kelvin)

## Submitter Information Verification

**Submitter Full Name:** Michael Anthony

**Organization:** Standards Michigan LLC

**Affiliation:** IEEE Education & Healthcare Facilities Committee

**Street Address:**

**City:**

**State:**

**Zip:**

**Submittal Date:** Thu Sep 07 16:16:06 EDT 2023

**Committee:** NEC-P15



## Public Input No. 1171-NFPA 70-2023 [ New Section after 517.6 ]

### **517.8 Patient Care Space Risk Categories and Risk Assessment.**

**(A) Risk Categories.** All activities, as well as systems and equipment, that are new or altered, shall be designed and installed to meet Patient Care Space Category 1 through Patient Care Space Category 4 requirements, as detailed in this Code. [ 99: 4.1]

Activities, systems, and equipment shall be permitted to be designed and installed to meet requirements for a more severe risk category. [ 99: 4.1.5]

**(1) Category 1.** Activities, systems, or equipment whose failure is likely to cause major injury or death of patients, staff, or visitors shall be designed and installed to meet Category 1 requirements, as detailed in this Code. [ 99: 4.1.1]

**(2) Category 2.** Activities, systems, or equipment whose failure is likely to cause minor injury of patients, staff, or visitors shall be designed and installed to meet Category 2 requirements, as detailed in this Code. [ 99: 4.1.2]

**(3) Category 3.** Activities, systems, or equipment whose failure is not likely to cause injury of patients, staff, or visitors shall be designed and installed to meet Category 3 requirements, as detailed in this Code. [ 99: 4.1.3]

**(4) Category 4.** Activities, systems, or equipment whose failure is likely to have no impact on patient care shall be designed and installed to meet Category 4 requirements, as detailed in this Code. [ 99: 4.1.4]

Informational Note No. 1: Major injuries can include the following:

- (1) Any amputation
- (2) Loss of the sight of an eye (whether temporary or permanent)
- (3) Chemical or hot metal burn to the eye or any penetrating injury to the eye
- (4) Any injury that results in electric shock and electric burns leading to unconsciousness and that requires resuscitation or admittance to a hospital for 24 hours or more
- (5) Any other injury that results in hypothermia, heat-induced shock, or unconsciousness requiring resuscitation or admittance to a hospital for 24 hours or more
- (6) Loss of consciousness caused by asphyxia or lack of oxygen or exposure to a biological agent or harmful substance
- (7) Absorption of any substance by inhalation, skin, or ingestion causing loss of consciousness or acute illness requiring medical treatment
- (8) Acute illness requiring medical treatment where there is reason to believe the exposure was to biological agents, toxins, or infected material

[ 99: A.4.1.1]

Informational Note No. 2: A minor injury means *not serious* or *not involving risk of life*. [ 99: A.4.1.2]

**(B) Risk Assessment.** The health care facility's governing body shall establish the processes and operations that are planned for the health care facility. The governing body shall conduct risk assessments and shall determine patient care space risk categories based on the character of the processes and operations conducted by the health care facility. [ 99: 4.2.1, 4.2.1.1]

Patient care space risk categories shall be classified by the health care facility's governing body by following and documenting a defined risk assessment procedure. Where required by the authority having jurisdiction, the risk assessment shall be provided to the authority having jurisdiction for review based on the character of the processes and operations conducted in the health care facility. [ 99: 4.2.2, 4.2.2.1]

A documented risk assessment shall not be required where Category 1 is selected. [ 99: 4.2.3]

Informational Note: See ISO/IEC 31010 , Risk Management — Risk Assessment Techniques ; NFPA 551 ; SEMI S10-0307E , Safety Guideline for Risk Assessment and Risk Evaluation Process ; or SFPE's Engineering Guide to Fire Risk Assessment for information and guidance on risk assessment procedures. The results of the assessment procedure should be documented and records retained. [ 99: A.4.2.2]

## Statement of Problem and Substantiation for Public Input

The distinctly separate responsibilities for RISK CATEGORY ASSIGNMENT (conducted by the Health Care Facility's Governing Body) of the patient care space versus for ENFORCEMENT (conducted by the AHJ) are explicitly delineated in NFPA 99, Health Care Facilities Code. By contrast, those same responsibilities are unstated in NFPA 70®.

As local urgent care clinics and intravenous (IV) infusion centers ("IV clinics", "IV bars") proliferate, these smaller health care facilities are often located in retail shopping plazas and similar commercial occupancies. Consequently, for those installers and electrical inspectors who utilize primarily or solely NEC® Article 517 (i.e. rarely use NFPA 99), jurisdictional confusion arises between, on one hand, NON-MEDICALLY-TRAINED electrical installers and electrical inspection enforcers and, on the other hand, operators of the smaller health care facilities located at those otherwise-ordinarily-commercial occupancies as to:

- whether it's the electrical inspector (AHJ) or Health Care Facility's Governing Body (c.f., Article 100 definition) who has authority and responsibility to ASSIGN AND DESIGNATE which Category number for any given space Patient Care Space, and
- whether Part II of Article 517 applies.

This Public Input seeks to add a new Section to Part I General of NEC® Article 517 to extract and add those same requirements for ASSESSMENT AND ASSIGNMENT of Patient Care Space Categories already long required by NFPA 99, Health Care Facilities Code. An NEC®-UNENFORCEABLE Informational Note No. 1 to Article 100 definition for Patient Care Space Category is actually what is MANDATED AND ENFORCEABLE by NFPA 99. Accordingly, a companion Public Input seeks correlation by deleting that Informational Note being replaced here with enforceable extracts from NFPA 99.

In accordance with 2.1.12.3.2 of the 2023 NEC® Style Manual, some editing of the extracted text was confined to making the style of the extracted text consistent with that of the 2023 NEC® Style Manual. Additionally, where in the NFPA 99, 4.1 Sections, the rules are stated as "shall be designed" for a PERFORMANCE Code, instead "shall be designed AND INSTALLED" was used because NEC® is an INSTALLATION Code. No matter how well designed it might be, if the installation doesn't also follow those requirements, compliance of the needed PERFORMANCE might not be achieved. Also, in the extract for Informational Note No 1 List Item 8, the singular "its" preceding "toxins" was deleted because that reference syntactically does not "pair" with any of the plural preceding nouns and toxin exposure may be fully independent of any "biological agents" .

## Related Public Inputs for This Document

<u>Related Input</u>	<u>Relationship</u>
<u>Public Input No. 1175-NFPA 70-2023 [Definition: Patient Care Space Category. [Excluding any Sub...]</u>	Deletion of unenforceable requirement MANDATED by NFPA 99
<u>Public Input No. 1175-NFPA 70-2023 [Definition: Patient Care Space Category. [Excluding any Sub...]</u>	

## Submitter Information Verification

**Submitter Full Name:** Brian Rock

**Organization:** Hubbell Incorporated

**Street Address:**

**City:**

**State:**

**Zip:**

**Submittal Date:** Thu Jun 22 03:05:40 EDT 2023

**Committee:** NEC-P15



## Public Input No. 2613-NFPA 70-2023 [ Section No. 517.6 ]

### 517.6 Patient Care-Related Electrical Equipment 3 Reconditioned Equipment .

The reconditioning requirements of this *Code* shall not apply to patient care-related electrical equipment.

Informational Note No. 1: Patient care-related electrical equipment is differentiated from electrical equipment as described in 110.21(A)(2).

Informational Note No. 2: If patient care-related electrical equipment is relocated, it is expected to be recommissioned or recertified in accordance with the U.S. *Federal Food, Drug, and Cosmetic Act (FDCA)*.

### Statement of Problem and Substantiation for Public Input

This Public Input is being submitted on behalf of the NEC Correlating Committee Usability Task Group in order to provide correlation throughout the document. The text is revised to comply with the NEC Style Manual Section 2.2.1 regarding reconditioned equipment.

2.2.1 Parallel Numbering Required. Technical committees shall use the following section numbers for the same purposes within articles. This requirement shall not apply to Articles 90, 100, and 110. If the article does not contain listing or reconditioning requirements, the subdivisions shall not be included in the article.

Required Parallel Numbering Format

XXX.1 Scope.

XXX.2 Listing Requirements.

XXX.3 Reconditioned Equipment.

XXX.3(A) Permitted to be Installed.

XXX.3(B) Not Permitted to be Installed.

The Usability Task Group members are: Derrick Atkins, David Hittinger, Richard Holub, Dean Hunter, Chad Kennedy and David Williams.

### Submitter Information Verification

**Submitter Full Name:** David Williams

**Organization:** Delta Charter Township

**Street Address:**

**City:**

**State:**

**Zip:**

**Submittal Date:** Wed Aug 23 20:14:01 EDT 2023

**Committee:** NEC-P15



## Public Input No. 1058-NFPA 70-2023 [ Section No. 517.10(B) ]

**(B)** Not Covered.

Part II shall not apply to the following:

- (1) Business offices, corridors, waiting rooms, and the like in clinics, medical and dental offices, and outpatient facilities
- (2) Spaces of nursing homes and limited care facilities wired in accordance with Chapters 1 through 4 of this *Code* where these spaces are used exclusively as patient sleeping rooms, as determined by the health care facility's governing body

Informational Note No. 1: See 406.12(5) for receptacles located in health care facility business offices, corridors, and waiting rooms that are required to be tamper resistant.

Informational Note No. 2: See 210.12(D) for branch circuits supplying outlets and receptacles located in patient sleeping rooms in nursing homes and limited care facilities that are connected to arc-fault circuit-interrupter circuits.

- (3) Areas used exclusively for any of the following purposes:

- (4) Intramuscular injections (immunizations)

- (5) Psychiatry and psychotherapy

- (6) ~~Alternative medicine~~

- (7) ~~Optometry~~

- a. Pharmacy services not contiguous to health care facilities

Informational Note No. 3: See NFPA *101 -2021, Life Safety Code*.

### Statement of Problem and Substantiation for Public Input

Article 517.10(B) exempts Alternative Medicine and Optometry from the typical wiring and protection in a normal medical office. Both of these types of medical offices could have the same people as any other medical office that may already be sick or medically compromised receiving medical care, and we are not providing them with the same level of wiring and protection that we would in any other medical office. Also, alternative medicine can include the same types of treatments as a chiropractor, or other medical professional such as a tens unit, etc. An optometrist also uses lights and electrical equipment to test eyes for several types of medical diagnosis'. Article 517 should include all types of medical office spaces for wiring and protection if there is any type of interaction between a human being and an electrically powered device of any kind. The other exceptions in this article are strictly for immunizations, and pharmacies where there is no electrically powered medical devices in direct contact with the patient and medical provider.

### Submitter Information Verification

**Submitter Full Name:** Clinton Stoddard

**Organization:** City of Rexburg

**Street Address:**

**City:**



**State:**

**Zip:**

**Submittal Date:** Tue Jun 13 13:22:38 EDT 2023

**Committee:** NEC-P15



## Public Input No. 1170-NFPA 70-2023 [ Section No. 517.10(B) ]

### (B) Not Covered.

Part II shall not apply to the following:

- (1) Business offices, corridors, waiting rooms, and the like in clinics, medical and dental offices, and outpatient facilities
- (2) Spaces of nursing homes and limited care facilities wired in accordance with Chapters 1 through 4 of this *Code* where these spaces are used exclusively as patient sleeping rooms, as determined by the health care facility's governing body

Informational Note No. 1: See 406.12(5) for receptacles located in health care facility business offices, corridors, and waiting rooms that are required to be tamper resistant.

Informational Note No. 2: See 210.12(D) for branch circuits supplying outlets and receptacles located in patient sleeping rooms in nursing homes and limited care facilities that are connected to arc-fault circuit-interrupter circuits.

- (3) ~~Areas~~ Spaces used exclusively for any of the following purposes:

- (4) Intramuscular (IM), subcutaneous (SC), and intradermal (ID) injections (immunizations)
- (5) Psychiatry and psychotherapy
- (6) Alternative medicine
- (7) Optometry
- (8) Pharmacy services not contiguous to health care facilities

Informational Note No. 3: See NFPA 101 -2021, Life Safety Code .

Informational Note No. 4: Intravenous (IV) infusions and transfusions, epidural infusions, and intraosseous (OS) injections are not considered to be intramuscular (IM), subcutaneous (SC), or intradermal (ID) injections, and are considered to be medical procedures that are accompanied by greater patient risk. Intravenous (IV) infusions and transfusions are not considered to be alternative medicine.

### Statement of Problem and Substantiation for Public Input

NOTA BENE: The changes and additions associated with this Public Input are solely to 517.10(B), to 517.10(B)(3) and its List Item a, and to NEW Informational Note No 4. Any other changes and spurious renumbering indicated legislatively elsewhere in this Section are attributable solely to NFPA's TerraView application program, still unremedied by NFPA, and are not attributable to or intended by the Submitter.

Intravenous (IV) infusion centers ("clinics") are proliferating commercially and confusion exists among non-medically-trained electrical installers and electrical inspection enforcers confronted by IV infusion facilities being located in ordinary commercial occupancies as to whether Part II of Article 517 applies and as to the responsibility of the Health Care Facilities' Governing Bodies (c.f., Article 100 definition) of those IV infusion facilities to make the necessary risk assessments and to assign Patient Care Space Categories. Consequently, non-medically-trained electrical installers and electrical inspection

enforcers are effectively making medical risk decisions for which they are unwittingly assuming potential liability, based upon the management of some IV infusion facilities "playing dumb" electrically to avoid incurring the essential safety requirements of Part II of Article 517.

In many states, although intravenous infusion therapy may be referred to as a cosmetic treatment, it is still classified legally as practicing medicine because it is performed via injection; only trained and licensed medical professionals may perform the infusion service. Other states may impose merely supervisory requirements and may have limitations regarding in what occupancies IV infusions can be conducted, such as in a medical clinic or in a commercial "IV Bar". Typically, IV infusion businesses nonetheless are categorized legally as full medical practices.<sup>1</sup>

While some states mandate particular practitioner certifications from the board of pharmacy to prepare and mix intravenous bags in that business, there are no specific certifications or licenses necessary to deliver intravenous infusions to the patients beyond the normal licenses required by that state, such as a business license, nursing license, etc.<sup>2</sup>

Risks associated with improper IV infusions and transfusions can potentially range "from irritation to fluid overload, infections, nerve damage, stroke, brain injury, or even death".<sup>3</sup> Other risks specific to IV infusions and transfusions include blood loss, blood clots, and air embolisms that may require immediate medical treatment.<sup>4, 5</sup>

Consequently, explicit informational clarification to non-medically-trained electrical installers and electrical inspection enforcers is essential to preclude misinterpretations that occupancies with spaces for intravenous infusions that are applicable in 517.10(A) are either equivalent to intramuscular injections not covered per 517.10(B)(3)a or (B)(3)c or are misrepresented as nonmedical treatments fully outside of Article 517.

"Areas" has been revised to "spaces" in 517.10(B)(3), consistent with usage throughout Article 517, NFPA 99 Health Care Facilities Code, and those portions of buildings being volumetric rather than surfaces.

<sup>1</sup> paraphrased from <https://lengealaw.com/is-iv-hydration-a-medical-practice>  
/#:~:text=In%20most%20states%2C%20although%20IV,professionals%20may%20perform%20the%20service "Is IV Hydration a Medical Practice?", by Lengea Law, December, 17 2022.

<sup>2</sup> paraphrased from <https://elitenp.com/iv-infusion-therapy-frequently-asked-questions/> "IV-Infusion Therapy Frequently Asked Questions", by Justin Allan, August 20, 2020.

<sup>3</sup> paraphrased from <https://www.dko-law.com/blog/common-hospital-errors-with-iv-insertion-can-be/>:~:text=When%20an%20IV%20is%20not,brain%20injury%2C%20or%20even%20death. "Common IV Insertion Errors – What Happens If IV Is Not In Vein?", by Dempsey, Kingsland and Osteen, December 5, 2013.

<sup>4</sup> paraphrased from <https://www.ncbi.nlm.nih.gov/pmc/articles/PMC6339323>  
/#:~:text=Compared%20to%20IM%20injection%2C%20mean,CI%3A%200.27%2C%200.91). National Institute of Health (NIH) National Library of Medicine (NLM) "[Comparison of] Intramuscular Injection, Intravenous Infusion, and Intravenous Bolus ...", by Dyanna Charles, Holly Anger, Rasha Dabash, Emad Darwish, Mohamed Cherine Ramadan, Amr Mansy, Yomna Salem, Ilana G. Dzuba, Meagan E. Byrne, Miral Breebaart, and Beverly Winikoff, January 18, 2019.

<sup>5</sup> paraphrased from <https://www.verywellhealth.com/infusion-therapy-5272053> "Infusion Therapy: What It Is and What to Expect", by Neha Kashyap, July 19, 2022.

## Submitter Information Verification

**Submitter Full Name:** Brian Rock

**Organization:** Hubbell Incorporated

**Street Address:**

**City:**

**State:**

**Zip:**

**Submittal Date:** Wed Jun 21 16:27:03 EDT 2023

**Committee:** NEC-P15



## Public Input No. 3545-NFPA 70-2023 [ Section No. 517.10(B) ]

**(B)** Not Covered.

Part II shall not apply to the following:

- (1) Business offices, corridors, waiting rooms, and ~~the like~~ spaces not intended for direct patient care in clinics, medical and dental offices, and outpatient facilities
- (2) Spaces of nursing homes and limited care facilities wired in accordance with Chapters 1 through 4 of this *Code* where these spaces are used exclusively as patient sleeping rooms, as determined by the health care facility's governing body

Informational Note No. 1: See 406.12(5) for receptacles located in health care facility business offices, corridors, and waiting rooms that are required to be tamper resistant.

Informational Note No. 2: See 210.12(D) for branch circuits supplying outlets and receptacles located in patient sleeping rooms in nursing homes and limited care facilities that are connected to arc-fault circuit-interrupter circuits.

- (3) Areas used exclusively for any of the following purposes:
  - (4) Intramuscular injections (immunizations)
  - (5) Psychiatry and psychotherapy
  - (6) Alternative medicine
  - (7) Optometry
  - (8) Pharmacy services not contiguous to health care facilities

Informational Note No. 3: See NFPA 101 -2021, *Life Safety Code* .

### Statement of Problem and Substantiation for Public Input

The phrase "and the like" is unclear. The edit makes it clear that the distinction is between areas where patients receive direct care, and those where they do not. By the way, i think we should consider applying this to hospitals as well.

### Submitter Information Verification

**Submitter Full Name:** Walter Vernon

**Organization:** Mazzetti

**Street Address:**

**City:**

**State:**

**Zip:**

**Submittal Date:** Mon Sep 04 19:02:11 EDT 2023

**Committee:** NEC-P15



## Public Input No. 2903-NFPA 70-2023 [ New Section after 517.12 ]

### TITLE OF NEW CONTENT

#### 517.11 + Service, feeder and branch circuit load calculations

Service, feeder and branch circuit load calculations for health care facilities shall be permitted to be based upon demonstrated loads, provided that such calculations are performed by a qualified person, as determined by the Authority Having Jurisdiction.

### Statement of Problem and Substantiation for Public Input

This proposal appeared as an Informational Note in this location for the 2023 revision and takes its inspiration from the Canadian Electrical Code.

"Demonstrated Load" -- which will be proposed to CMP-1 as a new definition -- permits a broader application of engineering judgement. The intent is to "rightsize" health care facilities power chain by giving design experts more freedom than presently allowed in Chapter 2.

Relevant Research led by Mazzetti Associates and the Fire Protection Research Foundation:

<https://www.nfpa.org/-/media/Files/News-and-Research/Fire-statistics-and-reports/Electrical/RFElectricCircuitData.pdf>

### Submitter Information Verification

**Submitter Full Name:** Michael Anthony

**Organization:** Standards Michigan LLC

**Affiliation:** IEEE Educaiton & Healthcare Facilities Committee

**Street Address:**

**City:**

**State:**

**Zip:**

**Submittal Date:** Sat Aug 26 08:27:25 EDT 2023

**Committee:** NEC-P15



## Public Input No. 2222-NFPA 70-2023 [ Section No. 517.13 ]

**517.13** Equipment Grounding Conductor for Receptacles and Fixed Electrical Equipment in Patient Care Spaces.

Wiring serving patient care spaces shall comply with the requirements of 517.13(A) and (B).

*Exception: Luminaires more than 2.3 m (7½ ft) above the floor and switches located outside of the patient care vicinity shall be permitted to be connected to an equipment grounding return path complying with the requirements of 517.13(A) or (B).*

### (A) Wiring Methods.

All branch circuits serving patient care spaces shall be provided with an effective ground-fault current path by installation in a metal raceway system or a cable having a metallic armor or sheath assembly. The metal raceway system, metallic cable armor, or sheath assembly shall itself qualify as an equipment grounding conductor in accordance with 250.118.

**(B)** Insulated Equipment Grounding Conductors and Insulated Equipment Bonding Jumpers. All branch circuit raceways serving patient care spaces shall be provided with an insulated copper equipment grounding conductor.

#### (1) General.

~~An insulated copper-~~ The equipment grounding conductor ~~that is-~~ shall be clearly identified along its entire length by green insulation- ~~and-~~ , shall be installed with the branch circuit conductors within the wiring method in accordance with 517.13(A) and shall be connected to the following:

- (1) Grounding terminals of all receptacles other than isolated ground receptacles
- (2) Metal outlet boxes, metal device boxes, or metal enclosures
- (3) Non-current-carrying conductive surfaces of fixed electrical equipment likely to become energized that are subject to personal contact, operating at over 100 volts

*Exception No. 1: For other than isolated ground receptacles, an insulated equipment bonding jumper that directly connects to the equipment grounding conductor shall be permitted to connect the box and receptacle(s) to the equipment grounding conductor. Isolated ground receptacles shall be connected in accordance with 517.16.*

*Exception No. 2: Metal faceplates shall be connected to an effective ground-fault current path by means of a metal mounting screw(s) securing the faceplate to a metal yoke or strap of a receptacle or to a metal outlet box.*

#### (2) Sizing.

Equipment grounding conductors and equipment bonding jumpers shall be sized in accordance with 250.122.

## Statement of Problem and Substantiation for Public Input

The wording for this requirement is somewhat confusing, as it never states that a ground wire is required, but rather infers that one is required.

We feel that revising as submitted to require a ground for all branch circuit raceways feeding patient care areas will make the statement more direct and therefore less confusing.

## Submitter Information Verification

**Submitter Full Name:** Jamie Schnick  
**Organization:** OSHPD/HCAI  
**Affiliation:** Office of Hospitals Planning and Development/Department of Healthcare Access and Information - California  
**Street Address:**  
**City:**  
**State:**  
**Zip:**  
**Submittal Date:** Tue Aug 15 11:54:52 EDT 2023  
**Committee:** NEC-P15





## Public Input No. 2328-NFPA 70-2023 [ Section No. 517.13 ]

**517.13** Equipment Grounding Conductor for Receptacles and Fixed Electrical Equipment in Patient Care Spaces.

Wiring serving patient care spaces shall comply with the requirements of 517.13(A) and (B).

~~*Exception: Luminaires more than 2.3 m ( 7 <sup>1</sup>/<sub>2</sub> ft) above the floor and switches located outside of the patient care vicinity shall be permitted to be connected to an equipment grounding return path complying with the requirements of 517.13( A) - or (B).*~~

(A)

### Wiring Methods.

All branch circuits serving patient care spaces shall be provided with an effective ground-fault current path by installation in a metal raceway system or a cable having a metallic armor or sheath assembly. The metal raceway system, metallic cable armor, or sheath assembly shall itself qualify as an equipment grounding conductor in accordance with 250.118.

**(B)** Insulated Equipment Grounding Conductors and Insulated Equipment Bonding Jumpers.

**(1)** General.

An insulated copper equipment grounding conductor that is clearly identified along its entire length by green insulation and installed with the branch circuit conductors within the wiring method in accordance with 517.13(A) shall be connected to the following:

- (1) Grounding terminals of all receptacles other than isolated ground receptacles
- (2) Metal outlet boxes, metal device boxes, or metal enclosures
- (3) Non-current-carrying conductive surfaces of fixed electrical equipment likely to become energized that are subject to personal contact, operating at over 100 volts

~~*Exception No. 1: Luminaires more than 2.3 m ( 7 <sup>1</sup>/<sub>2</sub> ft) above the floor and switches located outside of the patient care vicinity shall be permitted to be connected to an equipment grounding return path complying with the requirements of 517.13(A).*~~

~~*Exception No. 2: For other than isolated ground receptacles, an insulated equipment bonding jumper that directly connects to the equipment grounding conductor shall be permitted to connect the box and receptacle(s) to the equipment grounding conductor. Isolated ground receptacles shall be connected in accordance with 517.16.*~~

~~*Exception No. 3: Metal faceplates shall be connected to an effective ground-fault current path by means of a metal mounting screw(s) securing the faceplate to a metal yoke or strap of a receptacle or to a metal outlet box.*~~

**(2)** Sizing.

Equipment grounding conductors and equipment bonding jumpers shall be sized in accordance with 250.122.

## Statement of Problem and Substantiation for Public Input

The point of this exception is to be able to run a metal raceway system or a cable armor or sheath that qualifies as an equipment grounding conductor and not have to run an additional insulated equipment grounding conductor of the wire-type to luminaires and switches above 7 ½ ft above the floor located outside the patient care vicinity. The exception only applies to (B) because 517.13(B) already requires you to have a wiring method in accordance with 517.13(A). Moving the exception will add clarity to Code users.

## Submitter Information Verification

**Submitter Full Name:** Mike Holt

**Organization:** Mike Holt Enterprises Inc

**Street Address:**

**City:**

**State:**

**Zip:**

**Submittal Date:** Wed Aug 16 12:35:48 EDT 2023

**Committee:** NEC-P15



## Public Input No. 3176-NFPA 70-2023 [ Section No. 517.13 ]

**517.13** Equipment Grounding Conductor for Receptacles and Fixed Electrical Equipment in Patient Care Spaces.

~~Wiring~~ Branch circuits serving patient care spaces shall comply with the requirements of 517.13(A) and (B).

*Exception: Luminaires more than 2.3 m (7½ ft) above the floor and switches located outside of the patient care vicinity shall be permitted to be connected to an equipment grounding return path complying with the requirements of 517.13(A) or (B).*

### (A) Wiring Methods.

All branch circuits serving patient care spaces shall be provided with an effective ground-fault current path by installation in a metal raceway system or a cable having a metallic armor or sheath assembly. The metal raceway system, metallic cable armor, or sheath assembly shall itself qualify as an equipment grounding conductor in accordance with 250.118.

### (B) Insulated Equipment Grounding Conductors and Insulated Equipment Bonding Jumpers.

#### (1) General.

An insulated copper equipment grounding conductor that is clearly identified along its entire length by green insulation and installed with the branch circuit conductors within the wiring method in accordance with 517.13(A) shall be connected to the following:

- (1) Grounding terminals of all receptacles other than isolated ground receptacles
- (2) Metal outlet boxes, metal device boxes, or metal enclosures
- (3) Non-current-carrying conductive surfaces of fixed electrical equipment likely to become energized that are subject to personal contact, operating at over 100 volts

*Exception No. 1: For other than isolated ground receptacles, an insulated equipment bonding jumper that directly connects to the equipment grounding conductor shall be permitted to connect the box and receptacle(s) to the equipment grounding conductor. Isolated ground receptacles shall be connected in accordance with 517.16.*

*Exception No. 2: Metal faceplates shall be connected to an effective ground-fault current path by means of a metal mounting screw(s) securing the faceplate to a metal yoke or strap of a receptacle or to a metal outlet box.*

#### (2) Sizing.

Equipment grounding conductors and equipment bonding jumpers shall be sized in accordance with 250.122.

## Statement of Problem and Substantiation for Public Input

Revising text in section 517.13 to say 'Branch circuits' instead of 'Wiring' because that word is vague. For example, a Code user could interpret that feeders must also comply with the 517.13 requirements. This proposed revision improves usability and clarity for Code users.

## Submitter Information Verification

**Submitter Full Name:** Mike Holt

**Organization:** Mike Holt Enterprises Inc

**Street Address:**

**City:**

**State:**

**Zip:**

**Submittal Date:** Tue Aug 29 21:04:18 EDT 2023

**Committee:** NEC-P15



## Public Input No. 3177-NFPA 70-2023 [ Section No. 517.13 ]

**517.13** Equipment Grounding Conductor for Receptacles and Fixed Electrical Equipment in Patient Care Spaces.

Wiring serving patient care spaces shall comply with the requirements of 517.13(A) and (B).

~~*Exception: Luminaires more than 2.3 m ( 7 <sup>1</sup>/<sub>2</sub> ft) above the floor and switches located outside of the patient care vicinity shall be permitted to be connected to an equipment grounding return path complying with the requirements of 517.13( A) - or (B).*~~

(A)

### Wiring Methods.

All branch circuits serving patient care spaces shall be provided with an effective ground-fault current path by installation in a metal raceway system or a cable having a metallic armor or sheath assembly. The metal raceway system, metallic cable armor, or sheath assembly shall itself qualify as an equipment grounding conductor in accordance with 250.118.

*Exception: Luminaires more than 2.3 m ( 7 <sup>1</sup>/<sub>2</sub> ft) above the floor and switches located outside of the patient care vicinity shall not be required comply with 517.13(A) if the installation is in accordance with 517.13( B) .*

(B) Insulated Equipment Grounding Conductors and Insulated Equipment Bonding Jumpers.

(1) General.

An insulated copper equipment grounding conductor that is clearly identified along its entire length by green insulation and installed with the branch circuit conductors within the wiring method in accordance with 517.13(A) shall be connected to the following:

- (1) Grounding terminals of all receptacles other than isolated ground receptacles
- (2) Metal outlet boxes, metal device boxes, or metal enclosures
- (3) Non-current-carrying conductive surfaces of fixed electrical equipment likely to become energized that are subject to personal contact, operating at over 100 volts

*Exception No. 1: For other than isolated ground receptacles, an insulated equipment bonding jumper that directly connects to the equipment grounding conductor shall be permitted to connect the box and receptacle(s) to the equipment grounding conductor. Isolated ground receptacles shall be connected in accordance with 517.16.*

*Exception No. 2: Metal faceplates shall be connected to an effective ground-fault current path by means of a metal mounting screw(s) securing the faceplate to a metal yoke or strap of a receptacle or to a metal outlet box.*

*Exception No 3: Luminaires more than 2.3 m ( 7 <sup>1</sup>/<sub>2</sub> ft ) above the floor and switches located outside of the patient care vicinity shall not be required comply with 517.13(B) if the installation is in accordance with 517.13(A).*

(2) Sizing.

Equipment grounding conductors and equipment bonding jumpers shall be sized in accordance with 250.122.

## Statement of Problem and Substantiation for Public Input

Deleting exception from 517.13 and relocating an exception to 517.13(A) and another exception to 517.13(B). This proposed revision will give Code users the option of either complying with a 517.13(A)

wiring method or a 517.13(B) wiring method, instead of having to comply with both.

### Submitter Information Verification

**Submitter Full Name:** Mike Holt

**Organization:** Mike Holt Enterprises Inc

**Street Address:**

**City:**

**State:**

**Zip:**

**Submittal Date:** Tue Aug 29 21:06:00 EDT 2023

**Committee:** NEC-P15



## Public Input No. 1815-NFPA 70-2023 [ Section No. 517.13(A) ]

### (A) Wiring Methods.

All branch circuits serving patient care spaces shall be provided with an effective ground-fault current path by installation in a metal raceway system or a cable having a metallic armor or sheath assembly. The metal raceway system, metallic cable armor, or sheath assembly shall itself qualify as an equipment grounding conductor in accordance with 250.118. Outlet boxes, device boxes, junction boxes and other enclosures shall be metal.

### Statement of Problem and Substantiation for Public Input

This revision is needed to clarify that only metal boxes are permitted for these circuits! The present wording only applies to raceways and cables and does not prohibit installers from installing receptacles and switches in nonmetallic boxes. Section 314.3 exceptions 1 and 2 allow nonmetallic boxes with metal wiring methods, but using these boxes here may interrupt the continuity of the 2-part, effective ground-fault current path. One part being the metal raceways or metal cables, the other part being the insulated equipment grounding conductor. Using metal boxes will help ensure the continuity of these ground-fault current paths.

### Submitter Information Verification

**Submitter Full Name:** Russ Leblanc

**Organization:** Leblanc Consulting Services

**Street Address:**

**City:**

**State:**

**Zip:**

**Submittal Date:** Sat Aug 05 07:17:29 EDT 2023

**Committee:** NEC-P15



## Public Input No. 2309-NFPA 70-2023 [ Section No. 517.13(B) ]

### (B) Insulated Equipment Grounding Conductors and Insulated Equipment Bonding Jumpers.

#### (1) General.

An insulated copper equipment grounding conductor that is clearly identified along its entire length by green insulation and installed with the branch circuit conductors within the wiring method in accordance with 517.13(A) shall be connected to the following:

- (1) Grounding terminals of all receptacles other than isolated ground receptacles
- (2) Metal outlet boxes, metal device boxes, or metal enclosures
- (3) Non-current-carrying conductive surfaces of fixed electrical equipment likely to become energized that are subject to personal contact, operating at over 100 volts

#### Exception No. 4

- (1) Metal faceplates by means of a metal mounting screw(s) securing the faceplate to a metal yoke or strap of a receptacle or to a metal outlet box.

*Exception :* For other than isolated ground receptacles, an insulated equipment bonding jumper that directly connects to the equipment grounding conductor shall be permitted to connect the box and receptacle(s) to the equipment grounding conductor. Isolated ground receptacles shall be connected in accordance with 517.16.

*Exception No. 2:* ~~Metal faceplates shall be connected to an effective ground-fault current path by means of a metal mounting screw ( s) securing the faceplate to a metal yoke or strap of a receptacle or to a metal outlet box.~~

{

#### 2) Sizing.

Equipment grounding conductors and equipment bonding jumpers shall be sized in accordance with 250.122.

## Statement of Problem and Substantiation for Public Input

Moving Exception 2 to list item (4) of 517.13(B) because this is a requirement and not an exception. Even though metal faceplates are not required to be directly connected to the equipment grounding conductor, the language itself tells the means of how its considered connected to the equipment grounding conductor, just like 404.9(B) and 250.146.

## Submitter Information Verification

**Submitter Full Name:** Mike Holt

**Organization:** Mike Holt Enterprises Inc

**Street Address:**

**City:**

**State:**

**Zip:**

**Submittal Date:** Tue Aug 15 18:45:55 EDT 2023

**Committee:** NEC-P15





## Public Input No. 323-NFPA 70-2023 [ Section No. 517.13(B)(1) ]

### (1) General.

An insulated copper equipment grounding conductor that is clearly identified along its entire length by green insulation and installed with the branch circuit conductors within the wiring method in accordance with 517.13(A) shall be connected to the following:

- (1) Grounding terminals of all receptacles other than isolated ground receptacles
- (2) Metal outlet boxes, metal device boxes, or metal enclosures
- (3) Non-current-carrying conductive surfaces of fixed electrical equipment likely to become energized that are subject to personal contact, operating at over 100 volts

*Exception No. 1: For other than isolated ground receptacles, an insulated equipment bonding jumper that directly connects to the equipment grounding conductor shall be permitted to connect the box and receptacle(s) to the equipment grounding conductor. Isolated ground receptacles shall be connected in accordance with 517.16.*

*Exception No. 2: Metal faceplates shall be connected to an effective ground-fault current path by means of a metal mounting screw(s) securing the faceplate to a metal yoke or strap of a ~~receptacle or device~~ or to a metal outlet box.*

## Statement of Problem and Substantiation for Public Input

Metal plates can be installed on devices other than receptacles. Metal plates installed on switches are presently NOT covered by this exception. The literal wording in 517.13(B)(1)(3) requires the metal faceplate on a switch to be connected to an insulated copper EGC. My proposed revision will allow metal switch plates and metal plates installed on other devices to be grounded/bonded in the same manner metal receptacle plates can presently be grounded/bonded.

## Submitter Information Verification

**Submitter Full Name:** Russ Leblanc

**Organization:** Leblanc Consulting Services

**Street Address:**

**City:**

**State:**

**Zip:**

**Submittal Date:** Fri Feb 10 08:58:32 EST 2023

**Committee:** NEC-P15



## Public Input No. 1963-NFPA 70-2023 [ New Section after 517.13(B)(2) ]

### Testing

**(C) Grounding System Testing.** The effectiveness of the grounding systems in patient care spaces shall be tested in accordance with NFPA 99:6.3.3.1

**(D) Receptacle Testing.** Receptacles in patient care spaces shall be tested in accordance with NFPA 99:6.3.3.2

### Statement of Problem and Substantiation for Public Input

Testing requirements for Grounding Systems and Receptacles in Patient Care Spaces is missing: Recommendation is to add in NFPA 99 testing requirements for Grounding Systems and Receptacle Testing in Patient Care Spaces.

### Submitter Information Verification

**Submitter Full Name:** Jamie Schnick  
**Organization:** OSHPD/HCAI  
**Affiliation:** Office of Hospitals Planning and Development/Department of Healthcare Access and Information - California  
**Street Address:**  
**City:**  
**State:**  
**Zip:**  
**Submittal Date:** Tue Aug 08 18:34:52 EDT 2023  
**Committee:** NEC-P15



## Public Input No. 4379-NFPA 70-2023 [ Section No. 517.14 ]

### 517.14 Panelboard Enclosure Bonding.

The equipment grounding terminal buses of the normal and essential branch-circuit panelboards serving the same individual patient care vicinity shall be connected together with an insulated continuous copper conductor not smaller than 10 AWG. Where two or more enclosed panelboards serving the same individual patient care vicinity are served from separate transfer switches on the essential electrical system, the equipment grounding terminal buses of those ~~panelboards~~ panelboard enclosures shall be connected together with an insulated continuous copper conductor not smaller than 10 AWG. This conductor shall be permitted to be broken in order to terminate on the equipment grounding terminal bus in each panelboard enclosure .

*Exception: The insulated continuous copper conductor not smaller than 10 AWG shall be permitted to be terminated on listed connections to aluminum or copper busbars not smaller than 6 mm thick × 50 mm wide (¼ in. thick × 2 in. wide) and of sufficient length to accommodate the number of terminations necessary for the bonding of the ~~panelboards~~ panelboard enclosures . The busbar shall be securely fastened and installed in an accessible location.*

### Statement of Problem and Substantiation for Public Input

In 2023 a new definition “enclosed panelboard” was added, this has triggered the need to revise this section to recognize the equipment grounding terminal bars are often connected directly to the panelboard enclosures.

### Submitter Information Verification

**Submitter Full Name:** Kyle Krueger

**Organization:** NECA

**Affiliation:** NECA

**Street Address:**

**City:**

**State:**

**Zip:**

**Submittal Date:** Thu Sep 07 13:34:45 EDT 2023

**Committee:** NEC-P15



## Public Input No. 3659-NFPA 70-2023 [ Section No. 517.17(B) ]

### (B) Feeders.

Where ground-fault protection of equipment is provided for operation of the service disconnecting means or feeder disconnecting means as specified by 230.95 or 215.10, an additional step of ground-fault protection shall be provided in all next level feeder disconnecting means downstream toward the load. Such protection shall consist of overcurrent devices and current transformers or other protective equipment that shall cause the feeder disconnecting means to open.

The additional levels of ground-fault protection of equipment with automatic disconnecting means shall not be installed required on alternate power supply sources, between alternate power supply sources and any essential electrical system transfer switch, or on the load side of an any essential electrical system transfer switch. [99: 6.7.2.1.2.1]

Ground-fault indication without automatic disconnection shall be provided at any on-site power source. [99: 6.7.2.1.2.2]

### Statement of Problem and Substantiation for Public Input

There is currently no place in Article 517 that excludes the GF requirements of 215.10 for Feeders from Essential Electrical System feeders upstream of the transfer switches. It does prohibit GF downstream of essential electrical system transfer switches, and it is optional on essential electrical system sources. As is currently written, GF with automatic disconnecting is technically required for 1000A and larger feeders to essential electrical system transfer switches. This would be undesirable because a ground fault downstream of a transfer switch could trip both sources of power to that branch of the EES.

The ELS Committee of NFPA 99 recognized this potential issue and added the verbiage shown. This PI seeks to extract the same language to ensure that EES Feeders are not required to have GF protection with automatic disconnecting means.

### Submitter Information Verification

**Submitter Full Name:** Chris Finen

**Organization:** Eaton Corporation

**Street Address:**

**City:**

**State:**

**Zip:**

**Submittal Date:** Tue Sep 05 12:29:42 EDT 2023

**Committee:** NEC-P15



## Public Input No. 2098-NFPA 70-2023 [ Section No. 517.18(B)(1) ]

(1) Minimum Number and Supply.

Each patient bed location that requires at least 2 branch circuits shall be provided with a minimum of eight receptacles.

### Statement of Problem and Substantiation for Public Input

Clarification -

Recommend the proposed revision to avoid confusion.

### Submitter Information Verification

**Submitter Full Name:**

Jamie Schnick

**Organization:**

OSHPD/HCAI

**Affiliation:**

Office of Hospitals Planning and Development/Department of Healthcare Access and Information - California

**Street Address:**

**City:**

**State:**

**Zip:**

**Submittal Date:** Fri Aug 11 20:12:33 EDT 2023

**Committee:** NEC-P15



## Public Input No. 1475-NFPA 70-2023 [ Section No. 517.19(E) ]

### (E) Equipment Grounding and Bonding.

Where a grounded electrical distribution system is used and ~~metal feeder~~ a feeder(s) is installed in a metal raceway or Type MC or MI cable that qualifies as an equipment grounding conductor in accordance with 250.118 is installed, grounding of enclosures and equipment, such as panelboards, switchboards, and switchgear, shall be ensured by one of the following bonding means at each termination or junction point of the metal raceway or Type MC or MI cable:

- (1) A grounding bushing and a continuous copper bonding jumper, sized in accordance with 250.122, with the bonding jumper connected to the junction enclosure or the ground bus of the panel
- (2) Connection of feeder raceways or Type MC or MI cable to threaded hubs or bosses on terminating enclosures
- (3) Other approved devices such as bonding-type locknuts or bushings. Standard locknuts shall not be used for bonding.

### Statement of Problem and Substantiation for Public Input

This PI proposes revising the language for clarity and correlation with the wiring method mentioned. "Metal feeder raceways" are not a recognized wiring method. The requirement is addressing feeders, a defined term in Article 100, being installed in metal raceways.

### Submitter Information Verification

**Submitter Full Name:** Vincent Della Croce

**Organization:**

**Street Address:**

**City:**

**State:**

**Zip:**

**Submittal Date:** Thu Jul 20 10:22:45 EDT 2023

**Committee:** NEC-P15



## Public Input No. 1002-NFPA 70-2023 [ Section No. 517.19(H) ]

### (H) Special-Purpose Receptacle Grounding.

The equipment grounding conductor for special-purpose receptacles, such as the operation of mobile ~~X-ray equipment~~ diagnostic and treatment equipment, shall be extended to the reference grounding points of branch circuits for all locations likely to be served from such receptacles. Where such a circuit is served from an isolated ungrounded system, the equipment grounding conductor shall not be required to be run with the power conductors; however, the equipment grounding terminal of the special-purpose receptacle shall be connected to the reference grounding point.

### Statement of Problem and Substantiation for Public Input

By replacing "x-ray" with "diagnostic imaging and treatment," end users would benefit from the broader term. This also aligns with the title change to Part V of Article 517, made in the 2023 cycle.

### Submitter Information Verification

**Submitter Full Name:** Chris Papp

**Organization:** [ Not Specified ]

**Street Address:**

**City:**

**State:**

**Zip:**

**Submittal Date:** Thu Jun 08 19:27:47 EDT 2023

**Committee:** NEC-P15



## Public Input No. 2099-NFPA 70-2023 [ Section No. 517.20 ]

**517.20 Wet Procedure Locations** . Operating rooms shall be considered to be a wet procedure location unless a risk assessment conducted by the health care governing body determines otherwise. [99:6.3.2.3.4]

**(A) Receptacles and Fixed Equipment.**

Wet procedure locations shall be provided with special protection against electric shock.  
[99:6.3.2.3.1]

This special protection shall be provided by one of the following:

- (1) Isolated power systems that remain in operation in the event of a single line-to-ground fault condition that inherently limits the possible ground-fault current due to a first fault to a low value, without interrupting the power supply

Informational Note No. 1: Isolated power systems can eliminate the danger of electric shock to patients who might be more susceptible to leakage current and unable to move in their beds.

- (2) Power distribution system in which the power supply is interrupted if the ground-fault current does, in fact, exceed the trip value of a Class A GFCI

Informational Note No. 2: See Annex E of ANSI/UL 943-2018, *Ground-Fault Circuit-Interrupters*, and 110.3(B) for the manufacturers' installation instructions of listed ground-fault circuit interrupters for information on the supply connection of life-support equipment to circuits providing ground-fault circuit-interrupter (GFCI) protection of personnel at outlets.

[99:6.3.2.3.2]

*Exception: Branch circuits supplying only listed, fixed, therapeutic, and diagnostic equipment shall be permitted to be supplied from a grounded service, single- or 3-phase system if the following conditions are met:*

- (1) *Wiring for grounded and isolated circuits does not occupy the same raceway.*
- (2) *All conductive surfaces of the equipment are connected to an insulated copper equipment grounding conductor.*

**(B) Isolated Power Systems.**

Where an isolated power system is utilized, the isolated power equipment shall be listed as isolated power equipment, and the isolated power system shall be designed and installed in accordance with 517.160.

Informational Note: See Part IV of Article 680 for requirements on the installation of therapeutic pools and tubs.

### Statement of Problem and Substantiation for Public Input

Missing info from NFPA 99.

We propose to add in language from NFPA 99 that states "Operating rooms shall be considered to be a wet procedure location ..." to be consistent with requirement developed in NFPA 99.

### Submitter Information Verification

**Submitter Full** Jamie Schnick



**Name:**

**Organization:** OSHPD/HCAI

**Affiliation:** Office of Hospitals Planning and Development/Department of  
Healthcare Access and Information - California

**Street Address:**

**City:**

**State:**

**Zip:**

**Submittal Date:** Fri Aug 11 20:28:04 EDT 2023

**Committee:** NEC-P15



## Public Input No. 2100-NFPA 70-2023 [ Section No. 517.20(A) ]

### (A) Receptacles and Fixed Equipment.

Wet procedure locations shall be provided with special protection against electric shock.  
[99:6.3.2.3.1]

This special protection shall be provided by one of the following:

- (1) Isolated power systems that remain in operation in the event of a single line-to-ground fault condition that inherently limits the possible ground-fault current due to a first fault to a low value, without interrupting the power supply

Informational Note No. 1: Isolated power systems can eliminate the danger of electric shock to patients who might be more susceptible to leakage current and unable to move in their beds.

- (2) Power distribution system in which the power supply is interrupted if the ground-fault current does, in fact, exceed the trip value of a Class A GFCI
- (3) Where GFCI protection is used in an operating room, one of the following shall apply:
  - (4) Each receptacle shall be an individual GFCI device.
  - (5) Each receptacle shall be individually protected by a single GFCI device. [99:6.3.2.3].

Informational Note No. 2: See Annex E of ANSI/UL 943-2018, *Ground-Fault Circuit-Interrupters*, and 110.3(B) for the manufacturers' installation instructions of listed ground-fault circuit interrupters for information on the supply connection of life-support equipment to circuits providing ground-fault circuit-interrupter (GFCI) protection of personnel at outlets.

[99:6.3.2.3.2]

*Exception: Branch circuits supplying only listed, fixed, therapeutic, and diagnostic equipment shall be permitted to be supplied from a grounded service, single- or 3-phase system if the following conditions are met:*

- (1) *Wiring for grounded and isolated circuits does not occupy the same raceway.*
- (2) *All conductive surfaces of the equipment are connected to an insulated copper equipment grounding conductor.*

## Statement of Problem and Substantiation for Public Input

NFPA 99 alignment

Recommend that requirements from NFPA 99 are added for GFIC protection provided in OR's, to help maintain reliability of the wiring in the OR's for GFCI devices. (Note: Information note #2 is unchanged, should not be underlined - looks to be an auto formatting issue)

## Submitter Information Verification

**Submitter Full Name:** Jamie Schnick  
**Organization:** OSHPD/HCAI  
**Affiliation:** Office of Hospitals Planning and Development/Department of Healthcare Access and Information - California

**Street Address:**

**City:**

**State:**

**Zip:**

**Submittal Date:** Fri Aug 11 20:36:30 EDT 2023

**Committee:** NEC-P15



## Public Input No. 2972-NFPA 70-2023 [ Section No. 517.20(A) ]

### (A) Receptacles and Fixed Equipment.

Wet procedure locations shall be provided with special protection against electric shock.  
[99:6.3.2.3.1]

This special protection shall be provided by one of the following:

- (1) Isolated power systems that remain in operation in the event of a single line-to-ground fault condition that inherently limits the possible ground-fault current due to a first fault to a low value, without interrupting the power supply

Informational Note No. 1: Isolated power systems can eliminate the danger of electric shock to patients who might be more susceptible to leakage current and unable to move in their beds.

- (2) Power distribution system in which the power supply is interrupted if the ground-fault current does, in fact, exceed the trip value of a Class A GFCI

Informational Note No. 2: See Annex E of ANSI/UL 943-2018, *Ground-Fault Circuit-Interrupters*, and 110.3(B) for the manufacturers' installation instructions of listed ground-fault circuit interrupters for information on the supply connection of life-support equipment to circuits providing ground-fault circuit-interrupter (GFCI) protection of personnel at outlets.

[ 99: 6.3.2.3.2]

*Exception: Branch circuits supplying only listed, fixed, therapeutic, and diagnostic equipment shall be permitted to be supplied from a grounded service, single- or 3-phase system if the following conditions are met:*

- (1) *Wiring for grounded and isolated circuits does not occupy the same raceway.*
- (2) *All conductive surfaces of the equipment are connected to an insulated copper equipment grounding conductor.*

## Statement of Problem and Substantiation for Public Input

This public input is submitted on behalf of the Microgrid Task Group formed under the direction of the ELS Committee of NFPA 99 to provide correlation input to CMP-15 related to the use of microgrids and distributed energy resources in health care. The TG is also providing public inputs for consideration on any extracted language from 99 that has been modified in the 2024 edition of NFPA 99. Extraction reference needs to be updated to the correct location in 2024 NFPA 99.

Extraction language does not match existing 99 language. 517 language was revised in 2023 and has better clarity than 99 language. Since not a direct extraction, the extraction reference may need to be removed. 99 should revise wording to match the current wording in future editions. Then extraction can be returned.

## Submitter Information Verification

**Submitter Full Name:** Chris Finen

**Organization:** Eaton Corporation

**Street Address:**

**City:**

**State:**

**Zip:**

**Submittal Date:** Mon Aug 28 13:46:15 EDT 2023

**Committee:** NEC-P15



## Public Input No. 2747-NFPA 70-2023 [ Section No. 517.20(B) ]

### (B) Isolated Power Systems.

Where an isolated power system is utilized, the isolated power equipment shall be listed as isolated power equipment, and the isolated power system shall be designed and installed in accordance with 517.160.

Informational Note: See ~~Part IV of Article 680 - for~~ , Part IV for requirements on the installation of therapeutic pools and tubs.

### Statement of Problem and Substantiation for Public Input

This Public Input is being submitted on behalf of the NEC Correlating Committee Usability Task Group in order to provide correlation throughout the document. The text is revised to to comply with the NEC Style Manual Section 4.1.4, regarding the use of Parts.

4.1.4 References to an Entire Article. References shall not be made to an entire article, except for the Article 100 or where referenced to provide the necessary context. References to specific parts within articles shall be permitted. References to all parts of an article shall not be permitted. The article number shall precede the part number.

The Usability Task Group members are: Derrick Atkins, David Hittinger, Richard Holub, Dean Hunter, Chad Kennedy and David Williams.

### Submitter Information Verification

**Submitter Full Name:** David Williams

**Organization:** Delta Charter Township

**Street Address:**

**City:**

**State:**

**Zip:**

**Submittal Date:** Thu Aug 24 19:52:30 EDT 2023

**Committee:** NEC-P15



## Public Input No. 3767-NFPA 70-2023 [ New Section after 517.22 ]

517.23 Cybersecurity, Cyberweapon, Electromagnetic Pulse (EMP), Geomagnetic Disturbance (GMD), and

Intentional Electromagnetic Interference (IEMI) Protection. Health care facilities shall comply with either

of the following:

(1) The health care facility shall be identified for cybersecurity, cyberweapon, EMP, GMD, and IEMI

protection.

(2) A cybersecurity, cyberweapon, EMP, GMD, and IEMI protection failure modes effects

analysis assessment shall be conducted to determine health care facility vulnerabilities.

The identification or assessment shall be reviewed when the system configuration changes and at not more

than 5-year intervals. Documentation of the identification or assessment shall be made available to those

authorized to inspect, operate, and maintain the system.

### Additional Proposed Changes

<u>File Name</u>	<u>Description</u>	<u>Approved</u>
PC_464_CMP_15.pdf	NEC_PC464	

### Statement of Problem and Substantiation for Public Input

NOTE: This Public Input appeared as "Reject but Hold" in Public Comment No. 464 of the (A2022) Second Draft Report for NFPA 70 and per the Regs. at 4.4.8.3.1.

First and foremost, these requirements would be installation requirements, not performance requirements,

and therefor fall under the purview of CMP 15, not NFPA 99.

This Public Comment is a follow-up to PI 761, PI 3080, FR 8801, PI 767, PI 3070 and PI 4024. It does not

require cybersecurity, cyberweapon, EMP, GMD, or IEMI protection, but rather calls for the health care facility to be identified for these threats or for a threat assessment to be completed. While the NEC® is not

ready to mandate protection requirements, an assessment would show system vulnerabilities.

Acceptance of this Public Comment would at least bring the subject to the attention of owners, design engineers, electrical inspectors, and insurance companies, and set the table for requirements in future editions of the NEC® (or other NFPA standards). The format for this Public Comment is based upon the

cybersecurity requirements found in FR 8801, which offers an assessment as an alternate for requiring

protection.

PI 761 provided technical substantiation to require Electromagnetic Pulse (EMP) Protection for our critical infrastructure. While it appears that the NEC(R) is not ready to actually require EMP protection at this time, the security of our country is at stake. An EMP is fairly well understood as an extremely powerful electromagnetic wave that can impress 50,000 volts per meter on every piece of electrical equipment, destroying everything that is unprotected. An EMP is often associated with a nuclear explosion, but that is not the only cause of electromagnetic damage. A Geomagnetic Disturbance (GMD) is caused by a sunspot. While the EMP would be created by one of our adversaries, the sun spot is an act of God. These types of events can instantly initiate millions of fires in our unprotected electrical systems, overwhelming our fire-fighting capabilities. If millions of fires weren't bad enough, the unprotected electrical equipment would be damaged or completely destroyed, subjecting the country to years of blackout. Government intelligence studies, now unclassified, have predicted that from 66% to 90% of our population would die within one year, due to a lack of food, clean water, and medicine, if a significant EMP or GMD were to occur, while the country's electrical infrastructure remains unprotected. The final threat listed is an Intentional Electromagnetic Interference (IEMI). It is easily created by utilizing off-the-shelf parts, available for purchase on the internet, that will fit into a van. While much less powerful than a significant EMP or GMD, twenty vans, equipped with bench-made IEMI devices and scattered throughout the country, can shut down major industries and major parts of the country for weeks, if not months, through a coordinated attack, similar to 9/11, by targeting key industries/vulnerabilities. In conclusion, these electromagnetic threats to our unprotected electrical infrastructure, and therefor to our entire country, are absolutely real, and must be addressed.

PI 4024 provided significant substantiation for the need to protect critical infrastructure against cyber attack for equipment connected to the internet. However, equipment does not need to be connected to the internet in order to be damaged or destroyed by cyber threats. Equipment can be damaged by cyber weapons such as malicious computer worms that attack SCADA (control) systems. A great example is the Stuxnet worm that destroyed the centrifuges in Iran. Thus, this Public Comment deletes the PI 4024 reference to the internet and adds cyberweapon to the list of threats that need to be either protected against or assessed.

## Submitter Information Verification

**Submitter Full Name:** CMP ON NEC-P15  
**Organization:** Code-Making Panel 15  
**Street Address:**  
**City:**  
**State:**  
**Zip:**  
**Submittal Date:** Tue Sep 05 15:48:08 EDT 2023  
**Committee:** NEC-P15





## Public Comment No. 464-NFPA 70-2021 [ New Section after 517.22(B) ]

### TITLE OF NEW CONTENT

**517.23 Cybersecurity, Cyberweapon, Electromagnetic Pulse (EMP), Geomagnetic Disturbance (GMD), and Intentional Electromagnetic Interference (IEMI) Protection.** Health care facilities shall comply with either of the following:

(1) The health care facility shall be identified for cybersecurity, cyberweapon, EMP, GMD, and IEMI protection.

(2) A cybersecurity, cyberweapon, EMP, GMD, and IEMI protection failure modes effects analysis assessment shall be conducted to determine health care facility vulnerabilities. \_

The identification or assessment shall be reviewed when the system configuration changes and at not more than 5-year intervals. Documentation of the identification or assessment shall be made available to those authorized to inspect, operate, and maintain the system.

### Statement of Problem and Substantiation for Public Comment

First and foremost, these requirements would be installation requirements, not performance requirements, and therefor fall under the purview of CMP 15, not NFPA 99.

This Public Comment is a follow-up to PI 761, PI 3080, FR 8801, PI 767, PI 3070 and PI 4024. It does not require cybersecurity, cyberweapon, EMP, GMD, or IEMI protection, but rather calls for the health care facility to be identified for these threats or for a threat assessment to be completed. While the NEC® is not ready to mandate protection requirements, an assessment would show system vulnerabilities. Acceptance of this Public Comment would at least bring the subject to the attention of owners, design engineers, electrical inspectors, and insurance companies, and set the table for requirements in future editions of the NEC® (or other NFPA standards). The format for this Public Comment is based upon the cybersecurity requirements found in FR 8801, which offers an assessment as an alternate for requiring protection.

PI 761 provided technical substantiation to require Electromagnetic Pulse (EMP) Protection for our critical infrastructure. While it appears that the NEC(R) is not ready to actually require EMP protection at this time, the security of our country is at stake. An EMP is fairly well understood as an extremely powerful electromagnetic wave that can impress 50,000 volts per meter on every piece of electrical equipment, destroying everything that is unprotected. An EMP is often associated with a nuclear explosion, but that is not the only cause of electromagnetic damage. A Geomagnetic Disturbance (GMD) is caused by a sunspot. While the EMP would be created by one of our adversaries, the sun spot is an act of God. These types of events can instantly initiate millions of fires in our unprotected electrical systems, overwhelming our fire-fighting capabilities. If millions of fires weren't bad enough, the unprotected electrical equipment would be damaged or completely destroyed, subjecting the country to years of blackout. Government intelligence studies, now unclassified, have predicted that from 66% to 90% of our population would die within one year, due to a lack of food, clean water, and medicine, if a significant EMP or GMD were to occur, while the country's electrical infrastructure remains unprotected. The final threat listed is an Intentional Electromagnetic Interference (IEMI). It is easily created by utilizing off-the-shelf parts, available for purchase on the internet, that will fit into a van. While much less powerful than a significant EMP or GMD, twenty vans, equipped with bench-made IEMI devices and scattered throughout the country, can shut down major industries and major parts of the country for weeks, if not months, through a coordinated attack, similar to 9/11, by targeting key industries/vulnerabilities. In conclusion, these electromagnetic threats to our unprotected electrical infrastructure, and therefor to our entire country, are absolutely real, and must be addressed.

PI 4024 provided significant substantiation for the need to protect critical infrastructure against cyber attack for equipment connected to the internet. However, equipment does not need to be connected to the internet in order to be damaged or destroyed by cyber threats. Equipment can be damaged by cyber weapons such as malicious computer worms that attack SCADA (control) systems. A great example is the Stuxnet worm that destroyed the centrifuges in Iran. Thus, this Public Comment deletes the PI 4024 reference to the internet and adds cyberweapon to the list of threats that need to be either protected against or assessed.

#### Related Item

• PI 767 • PI 3080 • FR 8801 • PI 4024 • PI 3055 • FR 7947 • PI 4026 • FR 8880 • FR 8917 • PI 2888 • FR 8914 • PI 3083 • PI 3070

### Submitter Information Verification

**Submitter Full Name:** Vincent Saporita  
**Organization:** Saporita Consulting  
**Affiliation:** Saporita Consulting  
**Street Address:**  
**City:**  
**State:**  
**Zip:**  
**Submittal Date:** Tue Jul 27 18:32:48 EDT 2021  
**Committee:** NEC-P15

### Committee Statement

**Committee Action:** Rejected but held  
**Resolution:** The material submitted is new information and needs to be submitted as a public input to be acted on. The comment will be held for the next cycle, but the submitter is encouraged to also submit updated public inputs during the next cycle.

#### Copyright Assignment

I, Vincent Saporita, hereby irrevocably grant and assign to the National Fire Protection Association (NFPA) all and full rights in copyright in this Public Comment (including both the Proposed Change and the Statement of Problem and Substantiation). I understand and intend that I acquire no rights, including rights as a joint author, in any publication of the NFPA in which this Public Comment in this or another similar or derivative form is used. I hereby warrant that I am the author of this Public Comment and that I have full power and authority to enter into this copyright assignment.

By checking this box I affirm that I am Vincent Saporita, and I agree to be legally bound by the above Copyright Assignment and the terms and conditions contained therein. I understand and intend that, by checking this box, I am creating an electronic signature that will, upon my submission of this form, have the same legal force and effect as a handwritten signature



## Public Input No. 3754-NFPA 70-2023 [ New Section after 517.25 ]

### 517.28 Signs

#### (A) On-site Sources

A sign shall be placed at the service-entrance equipment, indicating type and location of each on-site power source.

Exception: A sign shall not be required for Battery-Equipped Emergency Luminaires.

#### (B) Grounding.

Where removal of a grounding or bonding connection in a power source equipment interrupts the grounding electrode conductor connection to another power source(s) grounded conductor, a warning sign shall be installed stating:

#### WARNING

SHOCK HAZARD EXISTS IF GROUNDING

ELECTRODE CONDUCTOR OR BONDING JUMPER

CONNECTION IN THIS EQUIPMENT IS REMOVED

WHILE ANOTHER SOURCE(S) IS ENERGIZED.

The warning sign(s) or label(s) shall comply with 110.21(B).

## Statement of Problem and Substantiation for Public Input

Related to PI 3664 eliminating the requirement for the Life Safety Branch to meet select requirements of Article 700.

The requirement for signage is currently required by Art. 700 but currently not included in 517. This PI brings this requirement into 517 for any EES source. The language was updated to reflect the elimination of the terms "normal source" and "alternate source" in favor of "on-site", etc. to support microgrid application of different source types.

## Related Public Inputs for This Document

<u>Related Input</u>	<u>Relationship</u>
<u>Public Input No. 3664-NFPA 70-2023 [Section No. 517.26]</u>	
<u>Public Input No. 3664-NFPA 70-2023 [Section No. 517.26]</u>	

## Submitter Information Verification

**Submitter Full Name:** Chris Finen

**Organization:** Eaton Corporation

**Street Address:**

**City:**

**State:**

**Zip:**

**Submittal Date:** Tue Sep 05 15:29:06 EDT 2023

**Committee:** NEC-P15



## Public Input No. 3756-NFPA 70-2023 [ New Section after 517.25 ]

### 517.29 Surge Protection.

A listed SPD shall be installed in or on all life safety and critical branch switchgear, switchboards, and panelboards.

### Statement of Problem and Substantiation for Public Input

Related to PI 3664 eliminating the requirement for the Life Safety Branch to meet select requirements of Article 700.

The requirement for surge protection is currently required for the Life Safety Branch by Art. 700 but currently not included in 517. This PI brings this surge requirement into 517. The Critical Branch was also added to the scope since this branch has the highest concentration of sensitive electronic apparatus that may be negatively affected by surges and directly related to patient care.

### Related Public Inputs for This Document

<u>Related Input</u>	<u>Relationship</u>
<a href="#">Public Input No. 3664-NFPA 70-2023 [Section No. 517.26]</a>	
<a href="#">Public Input No. 3664-NFPA 70-2023 [Section No. 517.26]</a>	

### Submitter Information Verification

**Submitter Full Name:** Chris Finen  
**Organization:** Eaton Corporation  
**Street Address:**  
**City:**  
**State:**  
**Zip:**  
**Submission Date:** Tue Sep 05 15:30:09 EDT 2023  
**Committee:** NEC-P15



## Public Input No. 2787-NFPA 70-2023 [ Section No. 517.25 ]

### **517.25** Essential Electrical Systems for Health Care Facilities.

Type 1 and Type 2 essential electrical systems (EES) for health care facilities shall comprise separate ~~branches~~ distribution systems capable of supplying a limited amount of lighting and power service, which is considered essential for life safety and orderly cessation of procedures ~~during the time normal electrical service is interrupted for any reason.~~ These loads shall not be without power for longer than ten seconds.

Informational Note: See NFPA 99-2021, *Health Care Facilities Code*, for information on essential electrical systems.

### Statement of Problem and Substantiation for Public Input

NFPA 99 has eliminated the use of the word "normal". NFPA has no definition of "normal power." NFPA 99 is clear that the issue is reliability of service to the Essential System Loads, and we need to specify the requirements.

### Submitter Information Verification

**Submitter Full Name:** Walter Vernon

**Organization:** Mazzetti

**Street Address:**

**City:**

**State:**

**Zip:**

**Submittal Date:** Thu Aug 24 21:05:10 EDT 2023

**Committee:** NEC-P15



## Public Input No. 4274-NFPA 70-2023 [ Section No. 517.25 ]

### 517.25 Essential Electrical Systems for Health Care Facilities.

Type 1 and Type 2 essential electrical systems (EES) for health care facilities shall be comprise ~~separate~~ of separate branches capable of supplying a limited amount of lighting and power service, which is considered essential for life safety- ~~and orderly~~ , patient care and the effective operation of the health care facility or orderly cessation of procedures during the time ~~normal electrical service is~~ tht the sources provided to support the entire site's electrical loads are interrupted for any reason.

Informational Note: See NFPA 99-2021, *Health Care Facilities Code*, for information on essential electrical systems.

### Statement of Problem and Substantiation for Public Input

The wording in this section appears to be incorrect, proposed revisions do not change the meaning of the section, but just helps clarify that the essential system needs to back-up life safety, critical and equipment loads.

### Related Public Inputs for This Document

<u>Related Input</u>	<u>Relationship</u>
<u>Public Input No. 4288-NFPA 70-2023 [Section No. 517.29 [Excluding any Sub-Sections]]</u>	

### Submitter Information Verification

**Submitter Full Name:** Jamie Schnick  
**Organization:** OSHPD/HCAI  
**Street Address:**  
**City:**  
**State:**  
**Zip:**  
**Submittal Date:** Thu Sep 07 09:12:46 EDT 2023  
**Committee:** NEC-P15



## Public Input No. 2789-NFPA 70-2023 [ Section No. 517.26 ]

### **517.26** Application of Other Articles.

The ~~life safety branch of the essential electrical system shall meet the requirements of Article 700 , except as amended as follows:~~

~~Section 700.4~~

~~shall not apply.~~

~~·~~

- ~~• Section 700.10(D) shall not apply.~~
- ~~• Section 700.17 shall be replaced with the following: Branch circuits that supply emergency lighting shall be installed to provide service from a source in accordance with 700.12 when normal supply for lighting is interrupted or where single circuits supply luminaires containing secondary batteries.~~
- ~~• Section 700.32 shall not apply.~~

~~Informational Note No. 1: See NFPA 110-2019, *Standard for Emergency and Standby Power Systems* , for additional information.~~

~~Informational Note No. 2: See 517.29 and NFPA 99-2021, *Health Care Facilities Code* , for additional information.~~

~~to health care facilities.~~

## Statement of Problem and Substantiation for Public Input

NFPA 99 and this Chapter specify all requirements for the health care essential electrical system.

## Submitter Information Verification

**Submitter Full Name:** Walter Vernon

**Organization:** Mazzetti

**Street Address:**

**City:**

**State:**

**Zip:**

**Submittal Date:** Thu Aug 24 21:09:53 EDT 2023

**Committee:** NEC-P15



## Public Input No. 3664-NFPA 70-2023 [ Section No. 517.26 ]

### **517.26** – Application of Other Articles.

The life safety branch of the essential electrical system shall meet the requirements of Article 700, except as amended as follows:

- (1) Section 700.4 shall not apply.
- (2) Section 700.10(D) shall not apply.
- (3) Section 700.17 shall be replaced with the following: Branch circuits that supply emergency lighting shall be installed to provide service from a source in accordance with 700.12 when normal supply for lighting is interrupted or where single circuits supply luminaires containing secondary batteries.
- (4) Section 700.32 shall not apply.

Informational Note No. 1: See NFPA 110-2019, *Standard for Emergency and Standby Power Systems*, for additional information.

Informational Note No. 2: See 517.29 and NFPA 99-2021, *Health Care Facilities Code*, for additional information.

### Additional Proposed Changes

<u>File Name</u>	<u>Description</u>	<u>Approved</u>
Art_700_-_Art_517_Life_Safety_Branch_correlation.docx	Complete review of Art. 700 to determine installation requirements needed for inclusion in Art. 517.	

### Statement of Problem and Substantiation for Public Input

This public input and related PI's 3754 and 3756 is being submitted to help resolve ongoing correlation / scope / enforcement issues related to Article 700 and the Life Safety Branch of the health care Essential Electrical System. The goal is to add clarity for code users and code enforcement officials and to reduce correlation issues moving forward. A similar effort was conducted by the NFPA 99 HEA ELS / NFPA 70 Task Group for the 2024 revision of NFPA 99 to ensure all performance related requirements for the Life Safety Branch of the EES were included in NFPA 99. This PI follows a similar process of reviewing all Article 700 installation requirements and offering separate, related PI's to incorporate any applicable installation requirements into Art. 517 rather than referencing 700.

The scope of Article 700 Emergency Systems differs from the Life Safety Branch of a health care EES. 700 has to cover the emergency system requirements for egress for all occupancy types. This has to include all the necessary, source, load, performance, maintenance, testing, installation, etc. requirements. The Life Safety Branch of a health care occupancy is only one branch of the EES and has very specific performance, maintenance, and testing requirements as defined in NFPA 99. The installation requirements for this branch of the EES for this specialized occupancy class should be consolidated into Art. 517. This will help clarify things for the code user and code enforcement professionals and reduce future correlation issues.

The attached supplemental documentation is a comprehensive review of all of Art. 700. Any installation related items that were not already excluded by 517 are submitted as separate related PI's for CMP-15 consideration. Goal is not to reduce any Life Safety Branch requirements, but rather consolidate them for this special occupancy type into Art. 517.



## Related Public Inputs for This Document

<u>Related Input</u>	<u>Relationship</u>
<a href="#">Public Input No. 3754-NFPA 70-2023 [New Section after 517.25]</a>	
<a href="#">Public Input No. 3756-NFPA 70-2023 [New Section after 517.25]</a>	
<a href="#">Public Input No. 3754-NFPA 70-2023 [New Section after 517.25]</a>	
<a href="#">Public Input No. 3756-NFPA 70-2023 [New Section after 517.25]</a>	

## Submitter Information Verification

**Submitter Full Name:** Chris Finen  
**Organization:** Eaton Corporation  
**Street Address:**  
**City:**  
**State:**  
**Zip:**  
**Submittal Date:** Tue Sep 05 12:49:31 EDT 2023  
**Committee:** NEC-P15

PI 3664 – Delete 517.26

**517.26 Application of Other Articles.**

The life safety branch of the essential electrical system shall meet the requirements of Article 700, except as amended as follows:

1. Section 700.4 shall not apply.
2. Section 700.10(D) shall not apply.
3. Section 700.17 shall be replaced with the following: Branch circuits that supply emergency lighting shall be installed to provide service from a source in accordance with 700.12 when normal supply for lighting is interrupted or where single circuits supply luminaires containing secondary batteries.
4. Section 700.32 shall not apply.

Informational Note No. 1: See NFPA 110-2019, *Standard for Emergency and Standby Power Systems*, for additional information.

Informational Note No. 2: See 517.29 and NFPA 99-2021, *Health Care Facilities Code*, for additional information.

**Existing Article 700 – [Recommended action is listed after each Part]**

**Part 1. General [EXCLUDE all of Part 1 except Signage and Surge Protection. Separate PI's submitted for those items to incorporate into 517.]**

**700.1 Scope. [EXCLUDE – scope conflicts with performance, maintenance, and testing scope of NFPA 99]**

This article applies to the electrical safety of the installation, operation, and maintenance of emergency systems consisting of circuits and equipment intended to supply, distribute, and control electricity for illumination, power, or both, to required facilities when the normal electrical supply or system is interrupted.

Informational Note No. 1: Emergency systems are generally installed in places of assembly where artificial illumination is required for safe exiting and for panic control in buildings subject to occupancy by large numbers of persons, such as hotels, theaters, sports arenas, health care facilities, and similar institutions. Emergency systems may also provide power for such functions as ventilation where essential to maintain life, fire detection and alarm systems, elevators, fire pumps, public safety communications systems, industrial processes where current interruption would produce serious life safety or health hazards, and similar functions.

Informational Note No. 2: See Article 517, Health Care Facilities, for further information regarding wiring and installation of emergency systems in health care facilities.

Informational Note No. 3: See NFPA 99-2018, Health Care Facilities Code, for further information regarding performance and maintenance of emergency systems in health care facilities.

Informational Note No. 4: See NFPA 101-2018, Life Safety Code, for specification of locations where emergency lighting is considered essential to life safety.

Informational Note No. 5: See NFPA 110-2019, Standard for Emergency and Standby Power Systems, and NFPA 111-2019, Standard on Stored Electrical Energy Emergency and Standby

**Commented [CMF1]:** This creates conflict with performance, maintenance, and testing scope of NFPA 99

**Commented [CMF2]:** Already refers users to Art. 517 and NFPA 99 for requirements.

Power Systems, for further information regarding performance of emergency and standby power systems. Emergency systems are considered Level 1 systems when applying NFPA 110.

**700.2 Reconditioned Equipment.**

Reconditioned transfer switches shall not be permitted.

**700.3 Tests and Maintenance. [EXCLUDE – purview of NFPA 99]**

(A) Commissioning Witness Test.

The authority having jurisdiction shall conduct or witness the commissioning of the complete system upon installation and periodically afterward.

Informational Note: See NECA 90, Standard for Commissioning Building Electrical Systems.

(B) Tested Periodically.

Systems shall be tested periodically on a schedule approved by the authority having jurisdiction to ensure the systems are maintained in proper operating condition.

(C) Maintenance.

Emergency system equipment shall be maintained in accordance with manufacturer instructions and industry standards.

(D) Written Record.

A written record shall be kept of such tests and maintenance.

(E) Testing Under Load.

Means for testing all emergency lighting and power systems during maximum anticipated load conditions shall be provided.

Informational Note: See NFPA 110-2019, Standard for Emergency and Standby Power Systems, for information on testing and maintenance of emergency power supply systems (EPSSs).

(F) Temporary Source of Power for Maintenance or Repair of the Alternate Source of Power.

If the emergency system relies on a single alternate source of power, which will be disabled for maintenance or repair, the emergency system shall include permanent switching means to connect a portable or temporary alternate source of power that shall be available for the duration of the maintenance or repair. The permanent switching means to connect a portable or temporary alternate source of power shall comply with the following:

(1)

Connection to the portable or temporary alternate source of power shall not require modification of the permanent system wiring.

(2)

Transfer of power between the normal power source and the emergency power source shall be in accordance with 700.12.

(3)

The connection point for the portable or temporary alternate source shall be marked with the phase rotation and system bonding requirements.

(4)

The switching means, including the interlocks, shall be listed and provided with mechanical or mechanical and electrical interlocking to prevent inadvertent interconnection of power sources.

(5)

The switching means shall include a contact point that shall annunciate at a location remote from the generator or at another facility monitoring system to indicate that the permanent emergency source is disconnected from the emergency system.

(6)

The permanent connection point for the temporary generator shall be located outdoors and shall not have cables from the connection point to the temporary generator routed through exterior windows, doors, or similar openings.

(7)

A permanent label shall be field applied at the permanent connection point to identify the system voltage, maximum amperage, short-circuit current rating of the load side of equipment supplied, and ungrounded conductor identification in accordance with 210.5.

It shall be permissible to use manual switching to switch from the permanent source of power to the portable or temporary alternate source of power and to utilize the switching means for connection of a load bank.

Informational Note: See Informational Note Figure 700.3(F) for one example of many possible methods to achieve the requirements of 700.3(F).

Exception: The permanent switching means to connect a portable or temporary alternate source of power, for the duration of the maintenance or repair, shall not be required where any of the following conditions exists:

(1)

All processes that rely on the emergency system source are capable of being disabled during maintenance or repair of the emergency source of power.

(2)

The building or structure is unoccupied and fire protection systems are fully functional and do not require an alternate power source.

(3)

Other temporary means can be substituted for the emergency system.

(4)

A permanent alternate emergency source, such as, but not limited to, a second on-site standby generator or separate electric utility service connection, capable of supporting the emergency system, exists.

#### ~~700.4 Capacity and Rating. [ALREADY EXCLUDED in 517.26]~~

##### ~~(A) Capacity.~~

~~An emergency system shall have adequate capacity in accordance with Parts I through IV of Article 220 or by another approved method. The system capacity shall be sufficient for the rapid load changes and transient power and energy requirements associated with any expected loads.~~

##### ~~(B) Selective Load Management.~~

~~The alternate power source shall be permitted to supply emergency, legally required standby, and optional standby system loads where the source has adequate capacity or where load management (that includes automatic selective load pickup and load shedding) is provided as needed to ensure adequate power to the following in order of priority:~~

(1)

Emergency circuits

(2)

Legally required standby circuits

(3)

Optional standby circuits

~~(C) Parallel Operation.~~

~~Parallel operation of the emergency source(s) shall consist of the sources specified in 700.4(C)(1) and (C)(2).~~

~~(1) Normal Source.~~

~~The emergency source shall be permitted to operate in parallel with the normal source in compliance with Part I or Part II of Article 705 where the capacity required to supply the emergency load is maintained at all times. Any operating condition that results in less than the required emergency source capacity shall initiate a system malfunction signal in accordance with 700.6(A).~~

~~Parallel operation shall be permitted for satisfying the test requirements of 700.3(B), provided all other conditions of 700.3 are met.~~

~~Informational Note: Peak load shaving is one application for parallel source operation.~~

~~(2) Emergency Source.~~

~~Emergency sources shall be permitted to operate in parallel where the necessary equipment to establish and maintain a synchronous condition is provided.~~

**700.5 Transfer Equipment. [EXCLUDE – transfer switch requirements are already covered in 99 / 517]**

(A) General.

Transfer equipment shall be automatic, listed, and marked for emergency use, and approved by the authority having jurisdiction. Transfer equipment shall be designed and installed to prevent the inadvertent interconnection of normal and emergency sources of supply in any operation of the transfer equipment. Transfer equipment and electric power production systems installed to permit operation in parallel with the normal source shall meet the requirements of Article 705. Meter-mounted transfer switches shall not be permitted for emergency system use.

(B) Bypass Isolation Transfer Switches.

Means shall be permitted to bypass and isolate the transfer equipment. Where bypass isolation transfer switches are used, inadvertent parallel operation shall be prevented.

(C) Automatic Transfer Switches.

Automatic transfer switches shall be electrically operated and mechanically held.

(D) Redundant Transfer Equipment.

If emergency loads are supplied by a single feeder, the emergency power system shall include redundant transfer equipment or a bypass isolation transfer switch to facilitate maintenance as required in 700.3(C) without jeopardizing continuity of power. If the redundant transfer equipment or bypass isolation transfer switch is manual (or nonautomatic), then it shall be actively supervised by a qualified person when the primary (automatic) transfer equipment is disabled for maintenance or repair.

Exception: The requirement for redundancy with the transfer equipment shall not apply where any of the following conditions exist:

(1)

All processes that rely on the emergency system source are capable of being disabled during maintenance or repair activities without jeopardizing the safety to human life.

(2)

The building or structure is unoccupied and fire protection systems are fully functional and do not require an alternate power source.

(3)

Other temporary means shall be permitted to be substituted for the emergency system.

(4)

A written emergency plan that includes mitigation actions and responsibilities for qualified persons to address the recognized site hazards for the duration of the maintenance or repair activities shall be developed and implemented. The emergency plan shall be made available to the authority having jurisdiction.

(E) Use.

Transfer equipment shall supply only emergency loads.

Informational Note: Transfer equipment that supplies emergency loads provides separation of this load type from any others and is independent of any equipment used to combine or parallel sources.

(F) Documentation.

The short-circuit current rating of the transfer equipment, based on the specific overcurrent protective device type and settings protecting the transfer equipment, shall be field marked on the exterior of the transfer equipment.

**700.6 Signals. [EXCLUDE – transfer switch features are included in NFPA 99]**

Audible, visual, and facility or network remote annunciation devices shall be provided, where applicable, for the purpose described in 700.6(A) through (D).

(A) Malfunction.

Malfunction signals indicate a malfunction of the emergency source.

(B) Carrying Load.

Load carrying signals indicate that the emergency source is carrying load.

(C) Storage Battery Charging Malfunction.

Storage battery charging malfunction signals indicate a charging malfunction on a battery required for source readiness, including starting the prime mover, is not functioning.

(D) Ground Fault.

Ground-fault signals indicate a ground fault in solidly grounded wye emergency systems of more than 150 volts to ground and circuit-protective devices rated 1000 amperes or more. The sensor for the ground-fault signal devices shall be located at, or ahead of, the main system disconnecting means for the emergency source, and the maximum setting of the signal devices shall be for a ground-fault current of 1200 amperes. Instructions on the course of action to be taken in the event of indicated ground fault shall be located at or near the sensor location.



For systems with multiple emergency sources connected to a paralleling bus, the ground fault sensor and the system bonding jumper shall be permitted to be at an alternative location.

**700.7 Signs.** [INCLUDE? – if signage requirement is needed, it needs to be added to 517 and the language updated to be appropriate to EES Sources. References to “normal” and “alternate” source need to be removed to correlate with 99.]

**Commented [CMF3]:** PI 3754

**(A) Emergency Sources.**

A sign shall be placed at the service-entrance equipment, indicating type and location of each on-site emergency power source.

**Commented [CMF4]:** There are no Emergency Sources in a health care facility. There are EES sources. If signage is needed for EES sources, this should be added to 517 because it applies to more than just the Life Safety Branch of the EES.

Exception: A sign shall not be required for individual unit equipment as specified in 700.12(H).

**(B) Grounding.**

Where removal of a grounding or bonding connection in normal power source equipment interrupts the grounding electrode conductor connection to the alternate power source(s) grounded conductor, a warning sign shall be installed at the normal power source equipment stating:

**Commented [CMF5]:** If this signage requirement is needed, it needs to be added to 517 and applied to ALL EES sources.

WARNING

SHOCK HAZARD EXISTS IF GROUNDING

ELECTRODE CONDUCTOR OR BONDING JUMPER

CONNECTION IN THIS EQUIPMENT IS REMOVED

WHILE ALTERNATE SOURCE(S) IS ENERGIZED.

The warning sign(s) or label(s) shall comply with 110.21(B).

**700.8 Surge Protection.** [INCLUDE? – CMP-15 should consider SPD requirement for health care facilities. Currently only applies to Life Safety Branch panels / switchboards. May need to consider application to Critical and Equipment Branches.]

**Commented [CMF6]:** PI 3756

A listed SPD shall be installed in or on all emergency system switchgear, switchboards, and panelboards.

**Part II. Circuit Wiring** [EXCLUDE – All Part II requirements related to circuit wiring are already included in 517 or are specifically excluded by 517.]

## 700.10 Wiring, Emergency System.

### (A) Identification.

Emergency circuits shall be permanently marked so they will be readily identified as a component of an emergency circuit or system by the following methods:

(1)

All boxes and enclosures (including transfer switches, generators, and power panels) for emergency circuits shall be permanently marked as a component of an emergency circuit or system.

(2)

Where boxes or enclosures are not encountered, exposed cable or raceway systems shall be permanently marked to be identified as a component of an emergency circuit or system, at intervals not to exceed 7.6 m (25 ft).

Receptacles supplied from the emergency system shall have a distinctive color or marking on the receptacle cover plates or the receptacles.

### (B) Wiring.

Wiring from an emergency source or emergency source distribution overcurrent protection to emergency loads shall be kept entirely independent of all other wiring and equipment unless otherwise permitted in the following

(1)

Wiring from the normal power source located in transfer equipment enclosures

(2)

Wiring supplied from two sources in exit or emergency luminaires

(3)

Wiring from two sources in a listed load control relay supplying exit or emergency luminaires, or in a common junction box, attached to exit or emergency luminaires

(4)

**Commented [CMF7]:** Marking and Identification of EES components is already covered in 517.31(C).

**Commented [CMF8]:** Receptacles are already required to have distinctive color or marking in 517.18(A), 517.19(A), 517.31(E), and 517.42(E)

**Commented [CMF9]:** Wiring requirements around separation of EES wiring are already covered in 517.31(C) and 517.42(D)

Wiring within a common junction box attached to unit equipment, containing only the branch circuit supplying the unit equipment and the emergency circuit supplied by the unit equipment

(5)

Wiring within a traveling cable to an elevator

(6)

Wiring from an emergency source to supply emergency and other (nonemergency) loads in accordance with the following:

a.

Separate vertical switchgear sections or separate vertical switchboard sections, with or without a common bus, or individual disconnects mounted in separate enclosures shall be used to separate emergency loads from all other loads.

b.

The common bus of separate sections of the switchgear, separate sections of the switchboard, or the individual enclosures shall be either of the following:

(i)

Supplied by single or multiple feeders without overcurrent protection at the source

(ii)

Supplied by single or multiple feeders with overcurrent protection, provided that the overcurrent protection that is common to an emergency system and any nonemergency system(s) is selectively coordinated with the next downstream overcurrent protective device in the nonemergency system(s)

c.

Emergency circuits shall not originate from the same vertical switchgear section, vertical switchboard section, panelboard enclosure, or individual disconnect enclosure as other circuits.

d.

It shall be permissible to use single or multiple feeders to supply distribution equipment between an emergency source and the point where the emergency loads are separated from all other loads.

e.

At the emergency power source, such as a generator, multiple integral overcurrent protective devices shall each be permitted to supply a designated emergency or a designated nonemergency load, provided that there is complete separation between emergency and nonemergency loads beginning immediately after the overcurrent protective device line-side connections.

Wiring of two or more emergency circuits supplied from the same source shall be permitted in the same raceway, cable, box, or cabinet.

**(C) Wiring Design and Location.**

Emergency wiring circuits shall be designed and located so as to minimize the hazards that might cause failure due to flooding, fire, icing, vandalism, and other adverse conditions.

**Commented [CMF10]:** Location of EES Components to minimize damage are already covered in 517.30(C) and 517.41(B).

~~(D) Fire Protection— [ ALREADY EXCLUDED in 517.26]~~

~~(1) Occupancies.~~

~~Emergency systems shall meet the additional requirements in 700.10(D)(2) through (D)(4) in the following occupancies:~~

~~(1)~~

~~Assembly occupancies for not less than 1000 persons~~

~~(2)~~

~~Buildings above 23 m (75 ft) in height~~

~~(3)~~

~~Educational occupancies with more than 300 occupants~~

~~(2) Feeder Circuit Wiring.~~

~~Feeder-circuit wiring shall meet one of the following conditions:~~

~~(1)~~

~~The cable or raceway is installed in spaces or areas that are fully protected by an approved automatic fire protection system.~~

~~(2)~~

~~The cable or raceway is protected by a listed electrical circuit protective system with a minimum 2-hour fire rating.~~

~~Informational Note No. 1: See UL 1724, Fire Tests for Electrical Circuit Protection Systems, for one method of defining an electrical circuit protective system. The UL Guide Information for Electrical Circuit Integrity Systems (FHIT) contains information to identify the system and its installation limitations to maintain a minimum 2-hour fire-resistive rating and is available from the certification body.~~

~~(3)~~

~~The cable or raceway is a listed fire-resistive cable system with a minimum 2-hour fire rating.~~

~~Informational Note No. 2: See UL 2196-2017, Standard for Fire Test for Circuit Integrity of Fire-Resistive Power, Instrumentation, Control and Data Cables, for one method of defining a fire-resistive cable system.~~

~~(4)~~

~~The cable or raceway is protected by a listed fire-rated assembly that has a minimum fire rating of 2 hours and contains only emergency circuits.~~

~~(5)~~

~~The cable or raceway is encased in a minimum of 50 mm (2 in.) of concrete.~~

~~(3) Feeder-Circuit Equipment.~~

~~Equipment for feeder circuits (including transfer switches, transformers, and panelboards) shall be located either in spaces fully protected by an approved automatic fire protection system or in spaces with a 2-hour fire-resistance rating.~~

~~(4) Source Control Wiring.~~

~~Control conductors installed between the emergency power supply system/stored-energy power supply system (EPSS/SEPS) and transfer equipment or control systems that initiate the operation of emergency sources or initiate the automatic connection to emergency loads shall be kept entirely independent of all other wiring and shall meet the conditions of 700.10(D)(2). The integrity of source control wiring shall be monitored for broken, disconnected, or shorted wires. Loss of integrity shall result in the following actions:~~

~~(1)~~

~~Generators. Shall start the generator(s).~~

~~(2)~~

~~All other sources. Shall be considered a system malfunction and initiate the designated signal(s) in 700.6(A).~~

**700.11 Wiring, Class-2-Powered Emergency Lighting Systems.**

(A) General.

Line voltage supply wiring and installation of Class 2 emergency lighting control devices shall comply with 700.10. Class 2 emergency circuits shall comply with 700.11(B) through (D).

(B) Identification.

Emergency circuits shall be permanently marked so they will be readily identified as a component of an emergency circuit or system by the following methods:

(1)

All boxes and enclosures for Class 2 emergency circuits shall be permanently marked as a component of an emergency circuit or system.

(2)

Exposed cable, cable tray, or raceway systems shall be permanently marked to be identified as a component of an emergency circuit or system, within 900 mm (3 ft) of each connector and at intervals not to exceed 7.6 m (25 ft).

(C) Separation of Circuits.

Class 2 emergency circuits shall be wired in a listed, jacketed cable or with one of the wiring methods of Chapter 3. If installed alongside nonemergency Class 2 circuits that are bundled, Class 2 emergency circuits shall be bundled separately. If installed alongside nonemergency Class 2 circuits that are not bundled, Class 2 emergency circuits shall be separated by a nonconductive sleeve or nonconductive barrier from all other Class 2 circuits. Separation from other circuits shall comply with 725.136.

(D) Protection.

Wiring shall comply with the requirements of 300.4 and be installed in a raceway, armored or metal-clad cable, or cable tray.

Exception No. 1: Section 700.11(D) shall not apply to wiring that does not exceed 1.83 m (6 ft) in length and that terminates at an emergency luminaire or an emergency lighting control device.

Exception No. 2: Section 700.11(D) shall not apply to locked rooms or locked enclosures that are accessible only to qualified persons.

Informational Note: Locked rooms accessible only to qualified persons include locked telecommunications rooms, locked electrical equipment rooms, or other access-controlled areas.

**Part III. Sources of Power [EXCLUDE all of Part III - Sources of Power for EES are covered in 517. Language is not consistent with 517 and source discussion applies to more than just Life Safety Branch.]**

700.12 General Requirements.

Current supply shall be such that, in the event of failure of the normal supply to, or within, the building or group of buildings concerned, emergency lighting, emergency power, or both shall be available within the time required for the application but not to exceed 10 seconds. The supply system for emergency purposes, in addition to the normal services to the building and meeting the general requirements of this section, shall be one or more of the types of systems described in 700.12(C) through (H). Unit equipment in accordance with 700.12(I) shall satisfy the applicable requirements of this article.

(A) Power Source Considerations.

In selecting an emergency source of power, consideration shall be given to the occupancy and the type of service to be rendered, whether of minimum duration, as for evacuation of a theater, or longer duration, as for supplying emergency power and lighting due to an indefinite period of current failure from trouble either inside or outside the building.

(B) Equipment Design and Location.

Equipment shall be designed and located so as to minimize the hazards that might cause complete failure due to flooding, fires, icing, and vandalism.

Equipment for sources of power as described in 700.12(C) through (H) shall be installed either in spaces fully protected by approved automatic fire protection systems or in spaces with a 2-hour fire rating where located within the following:

(1)

Assembly occupancies for more than 1000 persons

(2)

Buildings above 23 m (75 ft) in height with any of the following occupancy classes — assembly, educational, residential, detention and correctional, business, and mercantile

(3)

Educational occupancies with more than 300 occupants

Informational Note No. 1: See NFPA 101-2021, Life Safety Code, Section 6.1, for information on occupancy classifications.

Informational Note No. 2: See IEEE 3006.5-2014, Recommended Practice for the Use of Probability Methods for Conducting a Reliability Analysis of Industrial and Commercial Power Systems, for information regarding power system reliability.

(C) Supply Duration.

The emergency power source shall be of suitable rating and capacity to supply and maintain the total load for the duration determined by the system design. In no case shall the duration be less than 2 hours of system operation unless used for emergency illumination in 700.12(C)(4) or unit equipment in 700.12(H). Additionally, the power source shall comply with 700.12(C)(1) through (C)(5) as applicable.

Informational Note: See NFPA 110-2022, Standard for Emergency and Standby Power Systems, for information on classification of emergency power supply systems (EPSS).

(1) On-Site Fuel Supply.

An on-site fuel supply shall be provided, sufficient for not less than 2 hours operation of the system.

(2) Fuel Transfer Pumps.



Where power is needed for the operation of the fuel transfer pumps to deliver fuel to the source, these pumps shall be connected to the emergency power system.

(3) Public Gas System, Municipal Water Supply.

Sources shall not be solely dependent on a public utility gas system for their fuel supply or municipal water supply for their cooling systems.

Exception: Where approved by the authority having jurisdiction, the use of other than on-site fuels shall be permitted where there is a low probability of a simultaneous failure of both the off-site fuel delivery system and power from the outside electrical utility company. Where the public gas system is approved, the requirements of 700.12(C)(1) shall not apply.

(4) Storage Batteries and UPS.

Storage batteries and UPS used to supply emergency illumination shall be of suitable rating and capacity to supply and maintain the total load for a minimum period of 1 1/2 hours, without the voltage applied to the load falling below 87 1/2 percent of nominal voltage. Automotive-type batteries shall not be used. An automatic battery charging means shall be provided.

(5) Automatic Fuel Transfer

Where dual fuel sources are used, means shall be provided for automatically transferring from one fuel source to another.

(D) Generator Set.

(1) Prime Mover-Driven.

For a generator set driven by a prime mover approved by the authority having jurisdiction and sized in accordance with 700.4, means shall be provided for automatically starting the prime mover on failure of the normal power source and for automatic transfer and operation of all required electrical circuits. A time-delay feature shall be provided to avoid retransfer in case of short-time reestablishment of the normal source.

(2) Battery Power and Dampers.

Where a storage battery is used for control or signal power or as the means of starting the prime mover, it shall be suitable for the purpose and shall be equipped with an automatic charging means independent of the generator set. Where the battery charger is required for the operation of the generator set, it shall be connected to the

emergency system. Where power is required for the operation of dampers used to ventilate the generator set, the dampers shall be connected to the emergency system.

(3) Auxiliary Power Supply.

Generator sets that require more than 10 seconds to develop power shall be permitted if an auxiliary power supply energizes the emergency system until the generator can pick up the load.

(4) Outdoor Generator Sets.

Where an outdoor-housed generator set is equipped with a readily accessible disconnecting means in accordance with 445.18, and the disconnecting means is located within sight of the building or structure supplied, an additional disconnecting means shall not be required where ungrounded conductors serve or pass through the building or structure. Where the generator supply conductors terminate at a disconnecting means in or on a building or structure, the disconnecting means shall meet the requirements of 225.36.

Exception: For installations under single management, where conditions of maintenance and supervision ensure that only qualified persons will monitor and service the installation and where documented safe switching procedures are established and maintained for disconnection, the generator set disconnecting means shall not be required to be located within sight of the building or structure served.

(E) Stored-Energy Power Supply Systems (SEPSS).

Stored energy power supply systems shall comply with 700.12(E)(1) and (E)(2).

(1) Types.

Systems shall consist of one or more of the following system types:

(1)

Uninterruptible power supply (UPS)

Informational Note: See UL 1778, Uninterruptible Power Systems, for further information.

(2)

Fuel cell system

(3)

Energy storage system (ESS)

(4)

Storage battery

(5)

Other approved equivalent stored energy sources that comply with 700.12

(2) Fire Protection, Suppression, Ventilation, and Separation.

The systems in 700.12(E)(1) shall be installed with the fire protection, suppression, ventilation, and separation requirements specified in the manufacturer's instructions or equipment listing.

Informational Note: See NFPA 853-2020, Standard for the Installation of Stationary Fuel Cell Power Systems, and NFPA 855-2020, Standard for the Installation of Stationary Energy Storage Systems, for additional information on fire protection installation requirements.

(F) Separate Service.

Where approved by the authority having jurisdiction as suitable for use as an emergency source of power, an additional service shall be permitted. This service shall be in accordance with the applicable provisions of Article 230 and the following additional requirements:

(1)

Separate overhead service conductors, service drops, underground service conductors, or service laterals shall be installed.

(2)

The service conductors for the separate service shall be installed sufficiently remote electrically and physically from any other service conductors to minimize the possibility of simultaneous interruption of supply.

(G) Microgrid Systems.

On-site sources, designated as emergency sources, shall be permitted to be connected to a microgrid system.

The system shall isolate the emergency system from all nonemergency loads when the normal electric supply is interrupted or shall meet the requirements of 700.4(B). Interruption or partial or complete failure of the normal or nonemergency source(s) shall not impact the availability, capacity, and duration provided by the designated emergency sources.

The designated stored-energy electrical emergency power source(s) of a microgrid system shall be permitted to remain interconnected to any available power production source during operation of the emergency source(s) where the lack of, or failure of, the interconnected power production source(s), or related controls, does not impact system operation. Interconnected power production sources, other than the designated stored emergency power source(s), shall not be required to meet the requirements of this article.

(H) Battery-Equipped Emergency Luminaires.

(1) Listing.

All battery-equipped emergency luminaires shall be listed.

Informational Note No. 1: See ANSI/UL 924, Emergency Lighting and Power Equipment, for the requirements covering battery-equipped emergency luminaires and emergency battery packs. A listed emergency battery pack installed in a listed luminaire will provide similar functionality as a listed battery-equipped emergency luminaire.

Informational Note No. 2: Unit equipment is a type of battery-equipped emergency luminaire.

(2) Installation.

Battery-equipped emergency luminaires shall be installed in accordance with the following:

(1)

Battery-equipped emergency luminaires shall be permanently fixed in place (i.e., not portable).

(2)

Wiring to each luminaire shall be installed in accordance with the requirements of any of the wiring methods in Chapter 3 unless otherwise specified in Part II, IV, or V of this article. Flexible cord-and-plug connection shall be permitted for unit equipment, provided that the cord does not exceed 900 mm (3 ft) in length. Flexible cord, with or without a plug, shall also be permitted for battery-equipped emergency luminaires installed in accordance with 410.62(C)(1).

(3)

The branch circuit feeding the battery-equipped emergency luminaire shall be one of the following:

a.

The same branch circuit as that serving the normal lighting in the area and connected ahead of any local switches.

b.

The same or a different branch circuit as that serving the normal lighting in the area if that circuit is equipped with means to monitor the status of that area's normal lighting branch circuit ahead of any local switches.

c.

A separate branch circuit originating from the same panelboard as one or more normal lighting circuits. This separate branch circuit disconnecting means shall be provided with a lock-on feature.

(4)

The branch circuit that feeds battery-equipped emergency luminaires shall be clearly identified at the distribution panel.

(5)

Emergency luminaires that obtain power from a battery-equipped emergency luminaire shall be wired to the battery-equipped emergency luminaires as required in Part II, IV, or V of this article.

(6)

Remote luminaires providing lighting for the exterior of an exit door shall be permitted to be supplied by the battery-equipped emergency luminaire serving the area immediately inside the exit door.

**Part IV. Emergency System Circuits for Lighting and Power - [EXCLUDE all of Part IV – the specific loads required to be on the Life Safety Branch are already defined in 517 / 99. All other loads are prohibited.]**

700.15 Loads on Emergency Branch Circuits.

No appliances and no lamps, other than those specified as required for emergency use, shall be supplied by emergency lighting circuits.

700.16 Emergency Illumination.

(A) General.

Emergency illumination shall include means of egress lighting, illuminated exit signs, and all other luminaires specified as necessary to provide required illumination.

(B) System Reliability.

Emergency lighting systems shall be designed and installed so that the failure of any illumination source cannot leave in total darkness any space that requires emergency illumination.

Emergency lighting control devices in the emergency lighting system shall be listed for use in emergency systems. Listed unit equipment in accordance with 700.12(H) shall be considered as meeting the provisions of this section.

Informational Note: See 700.23 through 700.26 for applications of emergency system control devices.

(C) Discharge Lighting.

Where high-intensity discharge lighting such as high- and low-pressure sodium, mercury vapor, and metal halide is used as the sole source of normal illumination, the emergency lighting system shall be required to operate until normal illumination has been restored.

(D) Disconnecting Means.

Where an emergency system is installed, emergency illumination shall be provided in the area of the disconnecting means required by 225.31 and 230.70, as applicable, where the disconnecting means are installed indoors.

Exception: Alternative means that ensure that the emergency lighting illumination level is maintained shall be permitted.

#### 700.17 Branch Circuits for Emergency Lighting.

Branch circuits that supply emergency lighting shall be installed to provide service from a source complying with 700.12 when the normal supply for lighting is interrupted. Such installations shall provide either of the following:

(1)

An emergency lighting supply, independent of the normal lighting supply, with provisions for automatically transferring the emergency lights upon the event of failure of the normal lighting supply.

(2)

Two or more branch circuits supplied from separate and complete systems with independent power sources. One of the two power sources and systems shall be part of the emergency system, and the other shall be permitted to be part of the normal power source and system. Each system shall provide sufficient power for emergency lighting purposes.

Unless both systems are used for regular lighting purposes and both are kept lighted, means shall be provided for automatically energizing either system upon failure of the other. Either system or both systems shall be permitted to be a part of the general lighting of the protected occupancy if circuits supplying lights for emergency illumination are installed in accordance with other sections of this article.

#### 700.18 Circuits for Emergency Power.

For branch circuits that supply equipment classed as emergency, there shall be an emergency system supply source to which the load will be transferred automatically upon the failure of the normal supply.

#### 700.19 Multiwire Branch Circuits.

The branch circuit serving emergency lighting and power circuits shall not be part of a multiwire branch circuit.

**Part V. Control — Emergency Lighting Circuits** [EXCLUDE Part V – This content was incorporated into 99 in 6.7.5.1.2.6 and 6.7.5.1.2.7.]

**700.20 Switch Requirements.**

The switch or switches installed in emergency lighting circuits shall be arranged so that only authorized persons have control of emergency lighting.

Exception No. 1: Where two or more single-throw switches are connected in parallel to control a single circuit, at least one of these switches shall be accessible only to authorized persons.

Exception No. 2: Additional switches that act only to put emergency lights into operation but not disconnect them shall be permissible.

Switches connected in series or 3- and 4-way switches shall not be used.

**700.21 Switch Location.**

All manual switches for controlling emergency circuits shall be in locations convenient to authorized persons responsible for their actuation. In facilities covered by Articles 518 and 520, a switch for controlling emergency lighting systems shall be located in the lobby or at a place conveniently accessible thereto.

In no case shall a control switch for emergency lighting be placed in a motion-picture projection booth or on a stage or platform.

Exception: Where multiple switches are provided, one such switch shall be permitted in such locations where arranged so that it can only energize the circuit but cannot de-energize the circuit.

**700.22 Exterior Lights.**

Those lights on the exterior of a building that are not required for illumination when there is sufficient daylight shall be permitted to be controlled by an automatic light-actuated device.

**700.23 Dimmer and Relay Systems.**

A dimmer or relay system containing more than one dimmer or relay and listed for use in emergency systems shall be permitted to be used as a control device for energizing emergency lighting circuits. Upon failure of normal power, the dimmer or relay system shall be permitted to selectively energize only those branch circuits required to provide minimum emergency

**Commented [CMF11]: 6.7.5.1.2.6 Branch Circuits for Life Safety Lighting.**

Branch circuits supplying life safety lighting shall be served from a source in compliance with 6.7.1 when the normal supply for lighting is interrupted or where single circuits supply luminaires containing secondary batteries.

**6.7.5.1.2.7 Life Safety Lighting Circuit Switches.**

Life safety lighting circuit switches shall meet the following requirements:

(1) The switch(es) for the life safety lighting circuits shall be arranged so that only authorized persons have control of the life safety lighting switch(es) unless one of the following conditions are met:

(a) Where two or more single-throw switches are connected in parallel to control a single circuit, at least one of these switches is accessible only to authorized persons.

(b) Additional switches are included that act only to put life safety lights into operation, but not to disconnect them.

(2) Switches connected in series or 3- and 4-way switches shall not be used.

(3) All manual switches for controlling life safety lighting shall meet the following requirements:

(a) The manual switches shall be in locations convenient to authorized persons responsible for their actuation unless there are multiple switches provided.

(b) One of the switches shall be permitted to be located so that it can only energize, but not de-energize, the circuit.

**6.7.5.1.2.8 Life Safety Lighting Dimmer and Relay Systems.**

A dimmer or relay system containing more than one dimmer or relay and listed for emergency use shall be permitted to be used as a control device for energizing life safety lighting circuits.

**(A)** Upon failure of normal power, the dimmer or relay system shall be permitted to selectively energize only those branch circuits necessary to provide the minimum required illumination using a control bypass function.

**(B)** Where the dimmer or relay system is fed/supplied by an upstream transfer switch, normal power sensing for this function shall be permitted to be from a normal-only power source upstream of the transfer switch.

**6.7.5.1.2.9 Directly Controlled Life Safety Luminaires.**

Where life safety illumination is provided by a directly controlled life safety luminaire(s) that responds to an external control input, or loss



illumination using a control bypass function. Where the dimmer or relay system is fed by a normal/emergency power source from an upstream transfer switch, normal power sensing for this function shall be permitted to be from a normal-only power source upstream of the transfer switch. All branch circuits supplied by the dimmer or relay system cabinet shall comply with the wiring methods of Part II of Article 700.

#### 700.24 Directly Controlled Emergency Luminaires.

Where emergency illumination is provided by one or more directly controlled emergency luminaires that, upon loss of normal power, respond to an external control input to establish the required emergency illumination level, such directly controlled emergency luminaries shall be listed for use in emergency systems. Luminaires that are energized to the required emergency illumination level by disconnection of their control input by a listed emergency lighting control device shall not be required to be listed for use in emergency systems.

#### 700.25 Branch Circuit Emergency Lighting Transfer Switch.

Emergency lighting loads supplied by branch circuits rated at not greater than 20 amperes shall be permitted to be transferred from the normal branch circuit to an emergency branch circuit using a listed branch circuit emergency lighting transfer switch. The mechanically held requirement of 700.5(C) shall not apply to listed branch circuit emergency lighting transfer switches.

#### 700.26 Automatic Load Control Relay.

If an emergency lighting load is automatically energized upon loss of the normal supply, a listed automatic load control relay shall be permitted to energize the load. The load control relay shall not be used as transfer equipment.

#### 700.27 Class 2 Powered Emergency Lighting Systems.

Devices that combine control signals with Class 2 emergency power on a single circuit shall be listed as emergency lighting control devices.

Informational Note: An example of a device combining control signals with Class 2 emergency power sources is a Power over Ethernet (PoE) switch.

**Part VI. Overcurrent Protection [EXCLUDED Part VI other than GFPE (separate PI to add verbiage to 517.17 (B). Accessibility is already covered in 99. SelCoord is already excluded in 517.26]**

700.30 Accessibility. **[Already covered in 99: 6.7.5.1.2.7]**

The branch-circuit overcurrent devices in emergency circuits shall be accessible to authorized persons only.

#### 700.31 Ground-Fault Protection of Equipment.

The alternate source for emergency systems shall not be required to provide ground-fault protection of equipment with automatic disconnecting means. Ground-fault indication at the emergency source shall be provided in accordance with 700.6(D) if ground-fault protection of equipment with automatic disconnecting means is not provided.

#### ~~700.32 Selective Coordination.~~ **[Already EXCLUDED in 517.26]**

##### ~~(A) General.~~

~~Emergency system(s) overcurrent protective devices (OCPDs) shall be selectively coordinated with all supply-side and load-side OCPDs.~~

~~Selective coordination shall be selected by a licensed professional engineer or other qualified persons engaged primarily in the design, installation, or maintenance of electrical systems. The selection shall be documented and made available to those authorized to design, install, inspect, maintain, and operate the system.~~

##### ~~(B) Replacements.~~

~~Where emergency system(s) OCPDs are replaced, they shall be reevaluated to ensure selective coordination is maintained with all supply-side and load-side OCPDs.~~

##### ~~(C) Modifications.~~

~~If modifications, additions, or deletions to the emergency system(s) occur, selective coordination of the emergency system(s) OCPDs with all supply-side and load-side OCPDs shall be reevaluated.~~

~~Exception: Selective coordination shall not be required between two overcurrent devices located in series if no loads are connected in parallel with the downstream device.~~

~~Informational Note: See Informational Note Figure 700.32(C) for an example of how emergency system OCPDs selectively coordinate with all supply-side OCPDs. OCPD-D selectively coordinates with OCPDs C, F, E, B, and A. OCPD-C selectively coordinates with~~

**Commented [CMF12]: (Not related to 517 / 700 correlation – Provides means for EES feeders to not have GF with automatic disconnecting means)  
PI 3659 Add to 517.17 (B) -  
6.7.2.1.2 Ground-Fault Protection of Equipment, Essential Electrical System.  
6.7.2.1.2.1  
Ground-fault protection of equipment with automatic disconnecting means shall not be required on alternate power supply sources, between alternate power supply sources and any essential electrical system transfer switch, or on the load side of any essential electrical system transfer switch.  
6.7.2.1.2.2  
Ground-fault indication without automatic disconnection shall be provided at any alternate on-site power source.**

OCPDs F, E, B, and A. OCPD F selectively coordinates with OCPD E. OCPD B is not required to selectively coordinate with OCPD A because OCPD B is not an emergency system OCPD.

~~code book image: 8f1683b4-aa9c-11ec-a46d-e9dd887336cb~~

~~Informational Note Figure 700.32(C) Emergency System Selective Coordination.~~

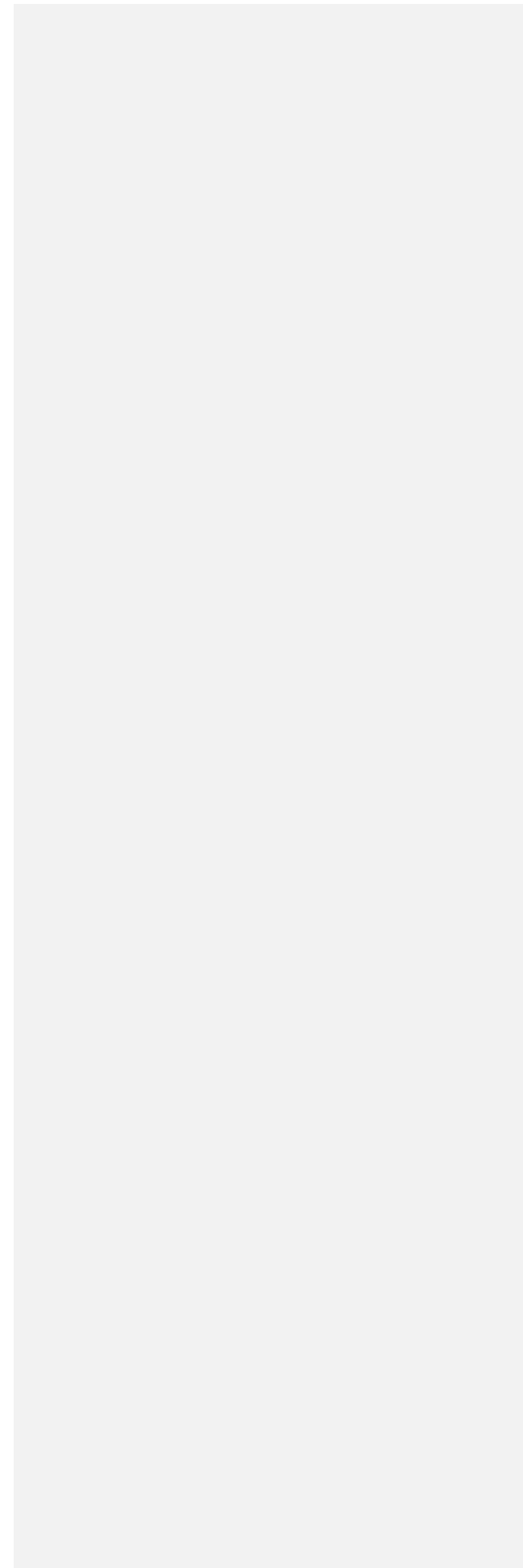



## Public Input No. 2790-NFPA 70-2023 [ Section No. 517.29 [Excluding any Sub-Sections] ]

Informational Note: Type 1 essential electrical systems are comprised of three separate branches capable of supplying a limited amount of lighting and power service that is considered essential for life safety and effective facility operation- ~~during the time the normal electrical service is interrupted for any reason~~ . These three separate branches are the life safety, critical, and equipment branches. [99:A.6.7.2.3]

### Statement of Problem and Substantiation for Public Input

NFPA 70 does not contain a definition of the word Normal. NFPA 99 does not use the word normal.

### Submitter Information Verification

**Submitter Full Name:** Walter Vernon

**Organization:** Mazzetti

**Street Address:**

**City:**

**State:**

**Zip:**

**Submittal Date:** Thu Aug 24 21:11:49 EDT 2023

**Committee:** NEC-P15



## Public Input No. 2849-NFPA 70-2023 [ Section No. 517.29 [Excluding any Sub-Sections] ]

Informational Note: Type 1 essential electrical systems are comprised of three separate branches capable of supplying a limited amount of lighting and power service that is considered essential for life safety and effective facility operation during the time the normal electrical service is interrupted for any reason. These three separate branches are the life safety, critical, and equipment branches. [99:A.6.7.2.5.3.1]

### Statement of Problem and Substantiation for Public Input

This public input is submitted on behalf of the Microgrid Task Group formed under the direction of the ELS Committee of NFPA 99 to provide correlation input to CMP-15 related to the use of microgrids and distributed energy resources in health care. The TG is also providing public inputs for consideration on any extracted language from 99 that has been modified in the 2024 edition of NFPA 99.

Extraction reference needs to be updated to the correct location in 2024 NFPA 99.

### Submitter Information Verification

**Submitter Full Name:** Chris Finen

**Organization:** Eaton Corporation

**Street Address:**

**City:**

**State:**

**Zip:**

**Submittal Date:** Fri Aug 25 15:03:06 EDT 2023

**Committee:** NEC-P15



## Public Input No. 4288-NFPA 70-2023 [ Section No. 517.29 [Excluding any Sub-Sections] ]

Informational Note: Type 1 essential electrical systems are comprised of three separate branches capable of supplying a limited amount of lighting and power service that is considered essential for life safety, critical patient care and effective facility operation of the health care facility or the orderly cessation of procedures during the time ~~the normal electrical service is~~ that the sources provided to support the entire site's electrical loads are is interrupted for any reason. These three separate branches are the life safety, critical, and equipment branches. [99:A.6.7.2.3]

### Statement of Problem and Substantiation for Public Input

Slight revision to match proposed 517.25 language.

### Related Public Inputs for This Document

<u>Related Input</u>	<u>Relationship</u>
<u>Public Input No. 4274-NFPA 70-2023 [Section No. 517.25]</u>	similar language/statement

### Submitter Information Verification

**Submitter Full Name:** Jamie Schnick  
**Organization:** OSHPD/HCAI  
**Street Address:**  
**City:**  
**State:**  
**Zip:**  
**Submittal Date:** Thu Sep 07 09:28:40 EDT 2023  
**Committee:** NEC-P15



## Public Input No. 1968-NFPA 70-2023 [ Section No. 517.30 ]

### 517.30 Sources of Power.

#### (A) Two Independent Power Sources.

~~The Essential electrical systems- Electrical System (EES) shall have two or more independent sources- sources (or sets of sources). One- In addition to the Services and Feeders called out in 517.4, each healthcare facility shall have one on-site source- source (or sets of sources) shall be sized to supply the entire EES. The other independent source (or sets of sources) shall be sized to supply the entire EES and shall be permitted to be located on-site or off-site. Additional sources other than the first two independent sources shall be permitted to be sized to supply the intended load Both sources (entire site and EES) can share resources, however neither source, nor sets of sources shall depend on resources, distribution equipment or pathways from the other to meet calculated load values for loads they are designated to feed.~~

*Clearly indicate all EES components on the design documents .*

Informational Note: An example of a set of sources may be several generators that combined serve the entire EES.

#### (B) Power Sources for the EES.

Power sources for the EES shall be permitted to be any of those specified in 517.30(B)(1) through (B)(5).

##### (1) Utility Supply Power.

Where utility power is used as the normal source, utility power shall not be used as the alternate source unless permitted elsewhere in this article.

Informational Note: See 517.35 and 517.45 for essential system loads that can be supplied from dual sources of utility supply power.

##### (2) Generating Units.

##### (3) Fuel Cell Systems.

Fuel cell systems shall be permitted to serve as the alternate power source for all or part of an EES. [99:6.7.1.5.1]

(a) Installation of fuel cells shall comply with the requirements in Parts I through VII of Article 692 for 1000 volts or less and Part VIII for over 1000 volts.

(b)  $N + 1$  units shall be provided where  $N$  units have sufficient capacity to supply the demand load of the portion of the system served.

(c) Systems shall be able to assume loads within 10 seconds of loss of normal power source.

(d) Systems shall have a continuing source of fuel supply, together with sufficient on-site fuel storage for the essential system type.

(e) Where life safety and critical portions of the distribution system are present, a connection shall be provided for a portable diesel generator.

Informational Note: See NFPA 853-2020, *Standard for the Installation of Stationary Fuel Cell Power Systems*, for information on installation of stationary fuel cells.

**(4) Energy Storage Systems.**

Energy storage systems shall be permitted to serve as the alternate source for all or part of an EES.

Informational Note: See NFPA 111-2022, *Standard on Stored Electrical Energy Emergency and Standby Power Systems*, for information on the installation of energy storage systems.

**(5) Health Care Microgrid.**

EES shall be permitted to be supplied by a health care microgrid that also supplies nonessential loads. The health care microgrid shall be permitted to share distributed resources with the normal system. Health care microgrid systems shall be designed with sufficient reliability to provide effective facility operation consistent with the facility emergency operations plan. Health care microgrid system components shall not be compromised by failure of the normal source.

Informational Note: See NFPA 99-2021, *Health Care Facilities Code*, for information on health care microgrids.

**(C) Location of EES Components.**

EES components shall be located to minimize interruptions caused by natural forces common to the area (e.g., storms, floods, earthquakes, or hazards created by adjoining structures or activities). [99:6.2.4.1]

**(1) Services.**

Installation of electrical service distribution equipment shall be located to reduce possible interruption of normal electrical services resulting from natural or manmade causes as well as internal wiring and equipment failures.

**(2) Feeders.**

Feeders shall be located to provide physical separation of the feeders of the alternate source and from the feeders of the normal electrical source to prevent possible simultaneous interruption. [99:6.2.4.3]

Informational Note: Facilities in which the normal source of power is supplied by two or more separate central station-fed services experience greater than normal electrical service reliability than those with only a single feed. Such a dual source of normal power consists of two or more electrical services fed from separate generator sets or a utility distribution network that has multiple power input sources and is arranged to provide mechanical and electrical separation so that a fault between the facility and the generating sources is not likely to cause an interruption of more than one of the facility service feeders.

## Statement of Problem and Substantiation for Public Input

The existing language is hard to follow and could lead to misinterpretation. We have tried to rewrite to simplify and allow that consistent interpretations can be made, as to the code requirements. Note: by saying that both sources (entire site and EES) can share resources, however neither source (nor sets of sources) shall depend on resources from the other to meet calculated loads values for loads they feed we can ensure that the two independent power sources are maintained. (These same revisions are proposed for Article 517.41)

## Related Public Inputs for This Document

<u>Related Input</u>	<u>Relationship</u>
<a href="#">Public Input No. 2132-NFPA 70-2023 [New Section after 517.1]</a>	
<a href="#">Public Input No. 2150-NFPA 70-2023 [Section No. 517.41]</a>	
<a href="#">Public Input No. 2132-NFPA 70-2023 [New Section after 517.1]</a>	
<a href="#">Public Input No. 2150-NFPA 70-2023 [Section No. 517.41]</a>	



## Submitter Information Verification

**Submitter Full Name:** Jamie Schnick  
**Organization:** OSHPD/HCAI  
**Affiliation:** Office of Hospitals Planning and Development/Department of Healthcare Access and Information - California  
**Street Address:**  
**City:**  
**State:**  
**Zip:**  
**Submittal Date:** Tue Aug 08 20:35:46 EDT 2023  
**Committee:** NEC-P15



## Public Input No. 2106-NFPA 70-2023 [ Section No. 517.30 ]

### **517.30** Sources of Power.

#### **(A)** Two Independent Power Sources.

Essential electrical systems (EES) shall have two or more independent sources (or sets of sources). One on-site source (or sets of sources) shall be sized to supply the entire EES. The other independent source (or sets of sources) shall be sized to supply the entire EES and shall be permitted to be located on-site or off-site. Additional sources other than the first two independent sources shall be permitted to be sized to supply the intended load.

Informational Note: An example of a set of sources may be several generators that combined serve the entire EES.

#### **(B)** Power Sources for the EES.

Power sources for the EES shall be permitted to be any of those specified in 517.30(B)(1) through (B)(5).

##### **(1)** Utility Supply Power.

Where utility power is used as the normal source, utility power shall not be used as the alternate source unless permitted elsewhere in this article.

Informational Note: See 517.35 and 517.45 for essential system loads that can be supplied from dual sources of utility supply power.

##### **(2)** Generating Units.

##### **(3)** Fuel Cell Systems.

Fuel cell systems shall be permitted to serve as the alternate power source for all or part of an EES. [99:6.7.1.5.1]

(a) Installation of fuel cells shall comply with the requirements in Parts I through VII of Article 692 for 1000 volts or less and Part VIII for over 1000 volts.

(b)  $N + 1$  units shall be provided where  $N$  units have sufficient capacity to supply the demand load of the portion of the system served.

(c) Systems shall be able to assume loads within 10 seconds of loss of normal power source.

(d) Systems shall have a continuing source of fuel supply, together with sufficient on-site fuel storage for the essential system type.

(e) Where life safety and critical portions of the distribution system are present, a connection shall be provided for a portable diesel generator.

Informational Note: See NFPA 853-2020, *Standard for the Installation of Stationary Fuel Cell Power Systems*, for information on installation of stationary fuel cells.

##### **(4)** Energy Storage Systems.

Energy storage systems shall be permitted to serve as the alternate source for all or part of an EES.

Informational Note: See NFPA 111-2022, *Standard on Stored Electrical Energy Emergency and Standby Power Systems*, for information on the installation of energy storage systems.

**(5) Health Care Microgrid.**

EES shall be permitted to be supplied by a health care microgrid that also supplies nonessential loads. The health care microgrid shall be permitted to share distributed resources with the normal system. Health care microgrid systems shall be designed with sufficient reliability to provide effective facility operation consistent with the facility emergency operations plan. Health care microgrid system components shall not be compromised by failure of the normal source.

Informational Note: See NFPA 99-2021, *Health Care Facilities Code*, for information on health care microgrids.

**(C) Location of EES Components.**

EES components shall be located to minimize interruptions caused by natural forces common to the area (e.g., storms, floods, earthquakes, or hazards created by adjoining structures or activities). [99:6.2.4.1]

**(1) Services.**

Installation of electrical service distribution equipment shall be located to reduce possible interruption of normal electrical services resulting from natural or manmade causes as well as internal wiring and equipment failures.

**(2) Feeders.**

Feeders shall be located to provide physical separation of the feeders of the alternate source and from the feeders of the normal electrical source to prevent possible simultaneous interruption. [99:6.2.4.3]

(D) The on-site EES sources, or set of sources shall have sufficient resources on-site to provide continuous essential power to meet site requirements.

Informational Note: Facilities in which the normal source of power is supplied by two or more separate central station-fed services experience greater than normal electrical service reliability than those with only a single feed. Such a dual source of normal power consists of two or more electrical services fed from separate generator sets or a utility distribution network that has multiple power input sources and is arranged to provide mechanical and electrical separation so that a fault between the facility and the generating sources is not likely to cause an interruption of more than one of the facility service feeders.

## Statement of Problem and Substantiation for Public Input

In article 700 the NEC only recognizes generators as Emergency Power Sources (EPS), and states that on-site generator fuel is required. Based on the new code changes allowing Healthcare Microgrids as Emergency Power Sources (EPSs) this language is confusing and misleading. This proposed addition allows for other on-site energy producers to be utilized as part of the EES and requires the combined EES resources to have adequate fuel and battery storage to meet minimum run time for EES. (The same revisions are proposed for Article 517.41)

## Related Public Inputs for This Document

<u>Related Input</u>	<u>Relationship</u>
<u>Public Input No. 2153-NFPA 70-2023 [Section No. 517.41]</u>	
<u>Public Input No. 2153-NFPA 70-2023 [Section No. 517.41]</u>	

## Submitter Information Verification

**Submitter Full Name:** Jamie Schnick  
**Organization:** OSHPD/HCAI

**Affiliation:** Both sources (entire site and EES) can share resources, however neither source, nor sets of sources shall depend on resources, distribution equipment or pathways from the other to meet calculated loads values for loads they are designated to feed.

**Street Address:**

**City:**

**State:**

**Zip:**

**Submittal Date:** Sat Aug 12 07:41:42 EDT 2023

**Committee:** NEC-P15



## Public Input No. 2108-NFPA 70-2023 [ Section No. 517.30 ]

### **517.30** Sources of Power.

#### **(A)** Two Independent Power Sources.

Essential electrical systems (EES) shall have two or more independent sources (or sets of sources). One on-site source (or sets of sources) shall be sized to supply the entire EES. The other independent source (or sets of sources) shall be sized to supply the entire EES and shall be permitted to be located on-site or off-site. Additional sources other than the first two independent sources shall be permitted to be sized to supply the intended load.

Informational Note: An example of a set of sources may be several generators that combined serve the entire EES.

#### **(B)** Power Sources for the EES.

Power sources for the EES shall be permitted to be any of those specified in 517.30(B)(1) through (B)(5).

##### **(1)** Utility Supply Power.

Where utility power is used as the normal source, utility power shall not be used as the alternate source unless permitted elsewhere in this article.

Informational Note: See 517.35 and 517.45 for essential system loads that can be supplied from dual sources of utility supply power.

##### **(2)** Generating Units.

##### **(3)** Fuel Cell Systems.

Fuel cell systems shall be permitted to serve as the alternate power source for all or part of an EES. [99:6.7.1.5.1]

(a) Installation of fuel cells shall comply with the requirements in Parts I through VII of Article 692 for 1000 volts or less and Part VIII for over 1000 volts.

(b)  $N + 1$  units shall be provided where  $N$  units have sufficient capacity to supply the demand load of the portion of the system served.

(c) Systems shall be able to assume loads within 10 seconds of loss of normal power source.

(d) Systems shall have a continuing source of fuel supply, together with sufficient on-site fuel storage for the essential system type.

(e) Where life safety and critical portions of the distribution system are present, a connection shall be provided for a portable diesel generator.

Informational Note: See NFPA 853-2020, *Standard for the Installation of Stationary Fuel Cell Power Systems*, for information on installation of stationary fuel cells.

##### **(4)** Energy Storage Systems.

Energy storage systems shall be permitted to serve as the alternate source for all or part of an EES.

Informational Note: See NFPA 111-2022, *Standard on Stored Electrical Energy Emergency and Standby Power Systems*, for information on the installation of energy storage systems.

**(5) Health Care Microgrid.**

EES shall be permitted to be supplied by a health care microgrid that also supplies nonessential loads. The health care microgrid shall be permitted to share distributed resources with the normal system. Health care microgrid systems shall be designed with sufficient reliability to provide effective facility operation consistent with the facility emergency operations plan. Health care microgrid system components shall not be compromised by failure of the normal source.

Informational Note: See NFPA 99-2021, *Health Care Facilities Code*, for information on health care microgrids.

**(C) Location of EES Components.**

EES components shall be located to minimize interruptions caused by natural forces common to the area (e.g., storms, floods, earthquakes, or hazards created by adjoining structures or activities). [99:6.2.4.1]

**(1) Services.**

Installation of electrical service distribution equipment shall be located to reduce possible interruption of normal electrical services resulting from natural or manmade causes as well as internal wiring and equipment failures.

**(2) Feeders.**

Feeders shall be located to provide physical separation of the feeders of the alternate source and from the feeders of the normal electrical source to prevent possible simultaneous interruption. [99:6.2.4.3]

**(D) Temporary Source of Power for Maintenance or Repair of the Alternate Source of Power.** The Essential Electrical System (EES) shall include permanent switching means to connect temporary or permanent on-site resources (energy sources and stored energy power supply systems) configured and sized adequately to provide power for the EES, such that additional resources can be connected (without rewiring) to meet essential power requirements during individual on-site resource equipment replacement, failures or maintenance.

Informational Note: Facilities in which the normal source of power is supplied by two or more separate central station-fed services experience greater than normal electrical service reliability than those with only a single feed. Such a dual source of normal power consists of two or more electrical services fed from separate generator sets or a utility distribution network that has multiple power input sources and is arranged to provide mechanical and electrical separation so that a fault between the facility and the generating sources is not likely to cause an interruption of more than one of the facility service feeders.

## Statement of Problem and Substantiation for Public Input

With the new concept of multiple on-site sources (or sets of sources) there is the risk of one of the sources needing maintenance or repair which could render the Essential Electrical System (EES) sources inadequate to back-up the entire EES. This proposed revision would provide the capability to connect temporary or permanent resources to the EES (without rewiring) to allow the potential (repairs or maintenance) of the on-site alternate power resources to proceed without the risk of insufficient resources on site to back up all essential loads. (The same language is proposed for section 517.41)

## Related Public Inputs for This Document

<u>Related Input</u>	<u>Relationship</u>
<u>Public Input No. 2154-NFPA 70-2023 [Section No. 517.41]</u>	
<u>Public Input No. 2154-NFPA 70-2023 [Section No. 517.41]</u>	

## Submitter Information Verification

**Submitter Full**    Jamie Schnick

**Name:**

**Organization:** OSHPD/HCAI

**Affiliation:** Office of Hospitals Planning and Development/Department of  
Healthcare Access and Information – California

**Street Address:**

**City:**

**State:**

**Zip:**

**Submittal Date:** Sat Aug 12 07:50:52 EDT 2023

**Committee:** NEC-P15



## Public Input No. 3549-NFPA 70-2023 [ Section No. 517.30 ]

### **517.30** – Sources of Power.

#### **(A)** – Two Independent Power Sources.

Essential electrical systems (EES) shall have two or more independent sources (or sets of sources). One on-site source (or sets of sources) shall be sized to supply the entire EES. The other independent source (or sets of sources) shall be sized to supply the entire EES and shall be permitted to be located on-site or off-site. Additional sources other than the first two independent sources shall be permitted to be sized to supply the intended load.

Informational Note: An example of a set of sources may be several generators that combined serve the entire EES.

#### **(B)** – Power Sources for the EES.

Power sources for the EES shall be permitted to be any of those specified in 517.30(B)(1) through (B)(5).

##### **(1)** – Utility Supply Power.

Where utility power is used as the normal source, utility power shall not be used as the alternate source unless permitted elsewhere in this article.

Informational Note: See 517.35 and 517.45 for essential system loads that can be supplied from dual sources of utility supply power.

##### **(2)** – Generating Units.

##### **(3)** – Fuel Cell Systems.

Fuel cell systems shall be permitted to serve as the alternate power source for all or part of an EES. [ ~~99: 6.7.1.5.1~~ ]

- (1) Installation of fuel cells shall comply with the requirements in Parts I through VII of Article 692 for 1000 volts or less and Part VIII for over 1000 volts.
- (2)  $N + 1$  units shall be provided where  $N$  units have sufficient capacity to supply the demand load of the portion of the system served.
- (3) Systems shall be able to assume loads within 10 seconds of loss of normal power source.
- (4) Systems shall have a continuing source of fuel supply, together with sufficient on-site fuel storage for the essential system type.
- (5) Where life safety and critical portions of the distribution system are present, a connection shall be provided for a portable diesel generator.

Informational Note: See NFPA 853-2020, *Standard for the Installation of Stationary Fuel Cell Power Systems*, for information on installation of stationary fuel cells.

##### **(4)** – Energy Storage Systems.

Energy storage systems shall be permitted to serve as the alternate source for all or part of an EES.

Informational Note: See NFPA 111-2022, *Standard on Stored Electrical Energy Emergency and Standby Power Systems*, for information on the installation of energy storage systems.



**(5) Health Care Microgrid.**

EES shall be permitted to be supplied by a health care microgrid that also supplies nonessential loads. The health care microgrid shall be permitted to share distributed resources with the normal system. Health care microgrid systems shall be designed with sufficient reliability to provide effective facility operation consistent with the facility emergency operations plan. Health care microgrid system components shall not be compromised by failure of the normal source.

*Informational Note:* See NFPA 99-2021, *Health Care Facilities Code*, for information on health care microgrids.

**(C) Location of EES Components.**

EES components shall be located to minimize interruptions caused by natural forces common to the area (e.g., storms, floods, earthquakes, or hazards created by adjoining structures or activities). [ 99: 6.2.4.1]

**(1) Services.**

Installation of electrical service distribution equipment shall be located to reduce possible interruption of normal electrical services resulting from natural or manmade causes as well as internal wiring and equipment failures.

**(2) Feeders.**

Feeders shall be located to provide physical separation of the feeders of the alternate source and from the feeders of the normal electrical source to prevent possible simultaneous interruption. [ 99: 6.2.4.3]

*Informational Note:* Facilities in which the normal source of power is supplied by two or more separate central station-fed services experience greater than normal electrical service reliability than those with only a single feed. Such a dual source of normal power consists of two or more electrical services fed from separate generator sets or a utility distribution network that has multiple power input sources and is arranged to provide mechanical and electrical separation so that a fault between the facility and the generating sources is not likely to cause an interruption of more than one of the facility service feeders.

## Statement of Problem and Substantiation for Public Input

All of this material should be moved into 517.2, and expanded to include sources for non-essential systems. As written, this section tries to describe both sources for the essential system and sources for non-essential loads, but it does so in a section for only Category 1 essential systems. It makes no sense for this content to be in this location.

## Related Public Inputs for This Document

<u>Related Input</u>	<u>Relationship</u>
Public Input No. 2515-NFPA 70-2023 [New Section after 517.1]	2515 is the relocated material from this section.

## Submitter Information Verification

**Submitter Full Name:** Walter Vernon

**Organization:** Mazzetti

**Street Address:**

**City:**

**State:**

**Zip:**

**Submittal Date:** Mon Sep 04 19:24:34 EDT 2023

**Committee:** NEC-P15



## Public Input No. 2792-NFPA 70-2023 [ Section No. 517.30(B) ]

### **(B)** Power Sources for the EES.

#### Power

Power sources for the EES shall be

permitted to be any of those specified in 517.30(B)(1) through (B)(5).

#### **(1)** ~~Utility Supply Power.~~

~~Where utility power is used as the normal source, utility power shall not be used as the alternate source unless permitted elsewhere in this article.~~

~~Informational Note: See 517.35 and 517.45 for essential system loads that can be supplied from dual sources of utility supply power.~~

#### **(2)** ~~Generating Units.~~

#### **(3)** ~~Fuel Cell Systems.~~

~~Fuel cell systems shall be permitted to serve as the alternate power source for all or part of an EES. [ 99: 6.7.1.5.1]~~

- ~~Installation of fuel cells shall comply with the requirements in Parts I through VII of Article 692 for 1000 volts or less and Part VIII for over 1000 volts.~~
- ~~N + 1 units shall be provided where N units have sufficient capacity to supply the demand load of the portion of the system served.~~
- ~~Systems shall be able to assume loads within 10 seconds of loss of normal power source. Systems shall have~~  
as described in 517..2

(C) Systems shall have a continuing source of fuel supply, together with sufficient on-site fuel storage for the essential system type.

(D) Where life safety and critical portions of the distribution system are present, a connection shall be provided for a portable diesel generator.

~~Informational Note: See NFPA 853-2020, *Standard for the Installation of Stationary Fuel Cell Power Systems*, for information on installation of stationary fuel cells.~~

#### **(4)** ~~Energy Storage Systems.~~

~~Energy storage systems shall be permitted to serve as the alternate source for all or part of an EES.~~

~~Informational Note: See NFPA 111~~

(E) Installation of Energy Storage Systems serving the EES shall comply with the requirements of NFPA 111 -2022, *Standard on Stored Electrical Energy Emergency and Standby Power Systems*

,

for information on the installation of energy storage systems.

**(5) Health Care Microgrid.**

EES shall be permitted to be supplied by a health care microgrid that also supplies nonessential loads. The health care microgrid shall be permitted to share distributed resources with the normal system. Health care microgrid systems shall be designed with sufficient reliability to provide effective facility operation consistent with the facility emergency operations plan. Health care microgrid system components shall not be compromised by failure of the normal source.

Informational Note: See NFPA 99-2021, *Health Care Facilities Code*, for information on health care microgrids.

**Statement of Problem and Substantiation for Public Input**

The information that applies to ALL sources has been moved to 517.2

**Related Public Inputs for This Document**

<b><u>Related Input</u></b>	<b><u>Relationship</u></b>
Public Input No. <a href="#">2515-NFPA 70-2023 [New Section after 517.1]</a>	the deleted content has been moved to provide more clarity.

**Submitter Information Verification**

**Submitter Full Name:** Walter Vernon  
**Organization:** Mazzetti  
**Street Address:**  
**City:**  
**State:**  
**Zip:**  
**Submittal Date:** Thu Aug 24 21:16:31 EDT 2023  
**Committee:** NEC-P15



## Public Input No. 3013-NFPA 70-2023 [ Section No. 517.30(B)(1) ]

### (1) Utility Supply Power.

Where utility power is used as the ~~normal~~ off-site power source, utility power shall not be used as the ~~alternate~~ on-site power source unless permitted elsewhere in this article.

Informational Note: See 517.35 and 517.45 for essential system loads that can be supplied from dual sources of utility supply power.

### Statement of Problem and Substantiation for Public Input

This public input is submitted on behalf of the Microgrid Task Group formed under the direction of the ELS Committee of NFPA 99 to provide correlation input to CMP-15 related to the use of microgrids and distributed energy resources in health care. The TG is also providing public inputs for consideration on any extracted language from 99 that has been modified in the 2024 edition of NFPA 99.

To support the use of various types of power sources, distributed energy resources, and microgrids, the terms "alternate" and "normal" need to be replaced with more generic terms for power sources such as "on-site" and "off-site".

### Submitter Information Verification

**Submitter Full Name:** Chris Finen

**Organization:** Eaton Corporation

**Street Address:**

**City:**

**State:**

**Zip:**

**Submittal Date:** Mon Aug 28 16:54:09 EDT 2023

**Committee:** NEC-P15



## Public Input No. 2748-NFPA 70-2023 [ Section No. 517.30(B)(3) ]

### (3) Fuel Cell Systems.

Fuel cell systems shall be permitted to serve as the alternate power source for all or part of an EES. [99:6.7.1.5.1]

(a) Installation of fuel cells shall comply with the requirements in Article 692, Parts I through ~~VII of Article 692 for VII for~~ 1000 volts or less and Part VIII for over 1000 volts.

(b) N + 1 units shall be provided where N units have sufficient capacity to supply the demand load of the portion of the system served.

(c) Systems shall be able to assume loads within 10 seconds of loss of normal power source.

(d) Systems shall have a continuing source of fuel supply, together with sufficient on-site fuel storage for the essential system type.

(e) Where life safety and critical portions of the distribution system are present, a connection shall be provided for a portable diesel generator.

Informational Note: See NFPA 853-2020, *Standard for the Installation of Stationary Fuel Cell Power Systems*, for information on installation of stationary fuel cells.

## Statement of Problem and Substantiation for Public Input

This Public Input is being submitted on behalf of the NEC Correlating Committee Usability Task Group in order to provide correlation throughout the document. The text is revised to to comply with the NEC Style Manual Section 4.1.4, regarding the use of Parts.

4.1.4 References to an Entire Article. References shall not be made to an entire article, except for the Article 100 or where referenced to provide the necessary context. References to specific parts within articles shall be permitted. References to all parts of an article shall not be permitted. The article number shall precede the part number.

The Usability Task Group members are: Derrick Atkins, David Hittinger, Richard Holub, Dean Hunter, Chad Kennedy and David Williams.

## Submitter Information Verification

**Submitter Full Name:** David Williams

**Organization:** Delta Charter Township

**Street Address:**

**City:**

**State:**

**Zip:**

**Submittal Date:** Thu Aug 24 19:53:20 EDT 2023

**Committee:** NEC-P15



## Public Input No. 3366-NFPA 70-2023 [ Section No. 517.30(B)(3) ]

### (3) Fuel Cell Systems.

Fuel cell systems shall be permitted to serve as the ~~alternate~~ on-site power source for all or part of an EES. - [ ~~99: 6.7.1.5.1~~ ]

(a) Installation of fuel cells shall comply with the requirements in Parts I through VII of Article 692 for 1000 volts or less and Part VIII for over 1000 volts.

(b) N + 1 units shall be provided where N units have sufficient capacity to supply the demand load of the portion of the system served.

(c) Systems shall be able to assume loads within 10 seconds of ~~less~~ interruption of ~~normal power source~~.

(d) Systems shall have a continuing source of fuel supply, together with sufficient on-site fuel storage for the essential system type.

(e) Where life safety and critical portions of the distribution system are present, a connection shall be provided for a portable diesel generator.

Informational Note: See NFPA 853-2020, *Standard for the Installation of Stationary Fuel Cell Power Systems*, for information on installation of stationary fuel cells.

## Statement of Problem and Substantiation for Public Input

This public input is submitted on behalf of the Microgrid Task Group formed under the direction of the ELS Committee of NFPA 99 to provide correlation input to CMP-15 related to the use of microgrids and distributed energy resources in health care. The TG is also providing public inputs for consideration on any extracted language from 99 that has been modified in the 2024 edition of NFPA 99.

6.7.1.5.1 was deleted from NFPA 99. This PI removes the extraction reference and updates the language from "alternate" to "onsite" and eliminates the term "normal" power source.

## Submitter Information Verification

**Submitter Full Name:** Chris Finen

**Organization:** Eaton Corporation

**Street Address:**

**City:**

**State:**

**Zip:**

**Submittal Date:** Fri Sep 01 14:46:44 EDT 2023

**Committee:** NEC-P15



## Public Input No. 998-NFPA 70-2023 [ Section No. 517.30(B)(3) ]

### (3) Fuel Cell Systems.

Fuel cell systems shall be permitted to serve as the alternate power source for all or part of an EES. [99:6.7.1.5.1]

(a) ~~Installation of fuel cells shall comply with the requirements in Parts I through VII of Article 692 for 1000 volts or less and Part VIII for over 1000 volts~~ applicable requirements in the fuel cell article .

(b) N + 1 units shall be provided where N units have sufficient capacity to supply the demand load of the portion of the system served.

(c) Systems shall be able to assume loads within 10 seconds of loss of normal power source.

(d) Systems shall have a continuing source of fuel supply, together with sufficient on-site fuel storage for the essential system type.

(e) Where life safety and critical portions of the distribution system are present, a connection shall be provided for a portable diesel generator.

Informational Note: See NFPA 853-2020, *Standard for the Installation of Stationary Fuel Cell Power Systems*, for information on installation of stationary fuel cells.

## Statement of Problem and Substantiation for Public Input

Section 4.1.4 of the NEC(r) Style Manual prohibits referencing an entire article except Article 100 or where required for context. Reference all sections of an article is prohibited as it is in effect referencing the entire article. In this case, though, there are only 6 parts of the article so this was inadvertently missed in the last revision and needs to be corrected not only for style manual reasons, but also for correlation with Article 692. Alternatively, this list item (a) could be deleted as 90.3 makes the organizational structure of the Code clear and Article 692 would apply to fuel cell systems even without this list item.

## Submitter Information Verification

**Submitter Full Name:** Richard Holub

**Organization:** The DuPont Company, Inc.

**Street Address:**

**City:**

**State:**

**Zip:**

**Submittal Date:** Thu Jun 08 15:07:45 EDT 2023

**Committee:** NEC-P15





## Public Input No. 3016-NFPA 70-2023 [ Section No. 517.30(B)(4) ]

### (4) Energy Storage Systems.

Energy storage systems shall be permitted to serve as the ~~alternate~~ on-site source for all or part of an EES.

Informational Note: See NFPA 111-2022, *Standard on Stored Electrical Energy Emergency and Standby Power Systems*, for information on the installation of energy storage systems.

### Statement of Problem and Substantiation for Public Input

This public input is submitted on behalf of the Microgrid Task Group formed under the direction of the ELS Committee of NFPA 99 to provide correlation input to CMP-15 related to the use of microgrids and distributed energy resources in health care. The TG is also providing public inputs for consideration on any extracted language from 99 that has been modified in the 2024 edition of NFPA 99.

To support the use of various types of power sources, distributed energy resources, and microgrids, the terms "alternate" and "normal" need to be replaced with more generic terms for power sources such as "on-site" and "off-site".

### Submitter Information Verification

**Submitter Full Name:** Chris Finen

**Organization:** Eaton Corporation

**Street Address:**

**City:**

**State:**

**Zip:**

**Submittal Date:** Mon Aug 28 17:08:23 EDT 2023

**Committee:** NEC-P15



## Public Input No. 3676-NFPA 70-2023 [ New Section after 517.30(C) ]

### 517.30(C)(6) NETWORK SWITCHES FOR POE EMERGENCY LIGHTING

(1) The switch that serves the emergency egress lighting will be dedicated to emergency egress

lighting, no other devices shall be connected to the switch or any other downstream component connected to the network switch.

(2) The switch that serves the emergency egress lighting will be physically separate from all other

systems, either in a locked rack or in another space altogether.

(3) The switch shall include a "time to energize" inscription on the nameplate indicating the number of seconds the switch takes to energize and provide power to the light fixtures after power is applied.

(4) The firmware of the switch shall comply with all the following requirements:

(5) The switch shall be designed to prevent Remote Access and Administration. The switch can only be configured through physically connecting to the switch.

(6) The switch should only be allowed software access through a form of Multi-Factor Authentication.

(7) The switch shall be designed such that adding a new device to a downstream connection results in that device not being operational without reconfiguring the switch.

(8) The firmware of the switch should only allow a firmware upgrade of to a new, listed cryptographically signed by the switch manufacturer (minimum of AES-256 bit encryption) firmware version, preventing generic firmware from being applied to the switch.

(9) Informational Note: The reason for the above firmware requirements are to reduce the possibility of an untrained Network Administrator or an untrained Telecommunication installer from accidentally effecting the function of the emergency egress lighting system. Since Network

Administrators, Telecommunication installers, and other non-Electrician personal may be adjusting the network topology of the system, frameworks shall be in place within the software

of the system to reduce the possibility of accidentally effecting the emergency egress lighting systems.

(10) The wiring to the light fixtures shall meet the requirements of physical separation per this

article. The sheething of the wire shall be marked in one of two ways below:

(11) Written indication that it is for emergency egress lighting only marked at the same interval as the listing requirements of the cable;

(12) The cable shall be a different color from all other network cables. The color shall be consistent throughout a facility.

### Additional Proposed Changes

<u>File Name</u>	<u>Description</u>	<u>Approved</u>
PC_92_CMP_15.pdf	NEC_PC92	
PC_92_Attachment.pdf	NEC_PC92_Attachment	

### Statement of Problem and Substantiation for Public Input

NOTE: This Public Input appeared as "Reject but Hold" in Public Comment No. 92 of the (A2022) Second Draft Report for NFPA 70 and per the Regs. at 4.4.8.3.1.

With the rapid development of Power over Ethernet (PoE) lighting I am concerned about the code-effects around emergency egress lighting in both hospitals and buildings. I am hoping to provide some guidelines around the minimum requirements for network deployed emergency egress lighting to ensure public safety is maintained as these systems are rapidly deployed.

Please note: I submitted this to the NEC 700.12 section also.

### Submitter Information Verification

**Submitter Full Name:** CMP ON NEC-P15  
**Organization:** Code-Making Panel 15  
**Street Address:**  
**City:**  
**State:**  
**Zip:**  
**Submittal Date:** Tue Sep 05 13:38:21 EDT 2023  
**Committee:** NEC-P15



## Public Comment No. 92-NFPA 70-2021 [ New Section after 517.30(D) ]

### **517.30(C)(6) NETWORK SWITCHES FOR POE EMERGENCY LIGHTING**

- (1) The switch that serves the emergency egress lighting will be dedicated to emergency egress lighting, no other devices shall be connected to the switch or any other downstream component connected to the network switch.
- (2) The switch that serves the emergency egress lighting will be physically separate from all other systems, either in a locked rack or in another space altogether.
- (3) The switch shall include a "time to energize" inscription on the nameplate indicating the number of seconds the switch takes to energize and provide power to the light fixtures after power is applied.
- (4) The firmware of the switch shall comply with all the following requirements:
  - (5) The switch shall be designed to prevent Remote Access and Administration. The switch can only be configured through physically connecting to the switch.
  - (6) The switch should only be allowed software access through a form of Multi-Factor Authentication.
  - (7) The switch shall be designed such that adding a new device to a downstream connection results in that device not being operational without reconfiguring the switch.
  - (8) The firmware of the switch should only allow a firmware upgrade of to a new, listed cryptographically signed by the switch manufacturer (minimum of AES-256 bit encryption) firmware version, preventing generic firmware from being applied to the switch.
  - (9) Informational Note: The reason for the above firmware requirements are to reduce the possibility of an untrained Network Administrator or an untrained Telecommunication installer from accidentally effecting the function of the emergency egress lighting system. Since Network Administrators, Telecommunication installers, and other non-Electrician personal may be adjusting the network topology of the system, frameworks shall be in place within the software of the system to reduce the possibility of accidentally effecting the emergency egress lighting systems.
- (10) The wiring to the light fixtures shall meet the requirements of physical separation per this article. The sheathing of the wire shall be marked in one of two ways below:
  - (11) Written indication that it is for emergency egress lighting only marked at the same interval as the listing requirements of the cable;
  - (12) The cable shall be a different color from all other network cables. The color shall be consistent throughout a facility.

2

## Additional Proposed Changes

<u>File Name</u>	<u>Description</u>	<u>Approved</u>
------------------	--------------------	-----------------

NEC\_517.30\_-\_PoE\_Network\_Switch\_-\_additional\_explanation.pdf

## Statement of Problem and Substantiation for Public Comment

With the rapid development of Power over Ethernet (PoE) lighting I am concerned about the code-effects around emergency egress lighting in both hospitals and buildings. I am hoping to provide some guidelines around the minimum requirements for network deployed emergency egress lighting to ensure public safety is maintained as these systems are rapidly deployed.

Please note: I submitted this to the NEC 700.12 section also.

## Related Public Comments for This Document

<u>Related Comment</u>	<u>Relationship</u>
<u>Public Comment No. 91-NFPA 70-2021 [New Part after IV.]</u>	Same comment.
<u>Related Item</u>	
• 517.30(C)(6) •	

## Submitter Information Verification

**Submitter Full Name:** Paul Erskine  
**Organization:** [ Not Specified ]  
**Street Address:**  
**City:**  
**State:**  
**Zip:**  
**Submission Date:** Thu Jul 01 19:24:12 EDT 2021  
**Committee:** NEC-P15

## Committee Statement

**Committee Action:** Rejected but held  
**Resolution:** The material submitted is new information and needs to be submitted as a public input to be acted on. The comment will be held for the next cycle, but the submitter is encouraged to also submit updated public inputs during the next cycle.

### Copyright Assignment

I, Paul Erskine, hereby irrevocably grant and assign to the National Fire Protection Association (NFPA) all and full rights in copyright in this Public Comment (including both the Proposed Change and the Statement of Problem and Substantiation). I understand and intend that I acquire no rights, including rights as a joint author, in any publication of the NFPA in which this Public Comment in this or another similar or derivative form is used. I hereby warrant that I am the author of this Public Comment and that I have full power and authority to enter into this copyright assignment.

By checking this box I affirm that I am Paul Erskine, and I agree to be legally bound by the above Copyright Assignment and the terms and conditions contained therein. I understand and intend that, by checking this box, I am creating an electronic signature that will, upon my submission of this form, have the same legal force and effect as a handwritten signature

To whom it may concern,

With the rapid development of Power over Ethernet (PoE) lighting I am concerned about the code-effects around emergency egress lighting in both hospitals and buildings.

The reason for my concern around these switches is due to the stability of networks from firmware upgrades and configurations. There are many stories over the last several years about network admins misapplying network configurations and taking down portions of the internet, such as the stories below. This is not intended to blame Network Admins, but they are not trained in the NEC and they may not even know what they are affecting. These are only stories because of the scale of the effect, we never hear about the building-wide or office-wide issue in the news.

- 2021-06-08: [Internet outage impacts websites and apps around the world: Live updates \(cnn.com\)](https://www.cnn.com/2021/06/08/internet-outage-websites-apps-world-intl/index.html). From the story: So what exactly happened? Fastly said it had identified a service configuration that triggered disruptions across its servers. The company has disabled that configuration.  
Link: <https://edition.cnn.com/world/live-news/internet-outage-websites-apps-world-intl/index.html>
- 2020-07-18: [Much Of The Internet Went Down Yesterday: Here's The Reason Why \(forbes.com\)](https://www.forbes.com/sites/daveywinder/2020/07/18/internet-down-human-error-not-cyber-attack-to-blame-says-cloudflare/). From the story: The outage...was caused by human error. ...and the subsequent internet outages, was "a configuration error in our backbone network."  
Link: <https://www.forbes.com/sites/daveywinder/2020/07/18/internet-down-human-error-not-cyber-attack-to-blame-says-cloudflare/>
- 2016-11-07: [BGP errors are to blame for Monday's Twitter outage, not DDoS attacks | CSO Online](https://www.csoonline.com/article/3138934/bgp-errors-are-to-blame-for-monday-s-twitter-outage-not-ddos-attacks.html). From the story: Early Monday morning, an engineer somewhere likely re-configured a router and accidentally removed the path to Twitter.com (AS13414) entirely.  
Link: <https://www.csoonline.com/article/3138934/bgp-errors-are-to-blame-for-monday-s-twitter-outage-not-ddos-attacks.html>

The intent of this upload is to provide a beginning concept for regulating PoE lighting when it involves emergency egress, life safety, or critical branch power. I understand this is not currently written exactly how code is written, but I am hoping the committee can adjust to make it appropriate.

Thank you for your consideration of this. Please let me know any questions.

To whom it may concern,

With the rapid development of Power over Ethernet (PoE) lighting I am concerned about the code-effects around emergency egress lighting in both hospitals and buildings.

The reason for my concern around these switches is due to the stability of networks from firmware upgrades and configurations. There are many stories over the last several years about network admins misapplying network configurations and taking down portions of the internet, such as the stories below. This is not intended to blame Network Admins, but they are not trained in the NEC and they may not even know what they are affecting. These are only stories because of the scale of the effect, we never hear about the building-wide or office-wide issue in the news.

- 2021-06-08: [Internet outage impacts websites and apps around the world: Live updates \(cnn.com\)](https://www.cnn.com/2021/06/08/internet-outage-intl/index.html). From the story: So what exactly happened? Fastly said it had identified a service configuration that triggered disruptions across its servers. The company has disabled that configuration.  
Link: <https://edition.cnn.com/world/live-news/internet-outage-websites-apps-world-intl/index.html>
- 2020-07-18: [Much Of The Internet Went Down Yesterday: Here's The Reason Why \(forbes.com\)](https://www.forbes.com/sites/daveywinder/2020/07/18/internet-down-human-error-not-cyber-attack-to-blame-says-cloudflare/). From the story: The outage...was caused by human error. ...and the subsequent internet outages, was "a configuration error in our backbone network."  
Link: <https://www.forbes.com/sites/daveywinder/2020/07/18/internet-down-human-error-not-cyber-attack-to-blame-says-cloudflare/>
- 2016-11-07: [BGP errors are to blame for Monday's Twitter outage, not DDoS attacks | CSO Online](https://www.csoonline.com/article/3138934/bgp-errors-are-to-blame-for-monday-s-twitter-outage-not-ddos-attacks.html). From the story: Early Monday morning, an engineer somewhere likely re-configured a router and accidentally removed the path to Twitter.com (AS13414) entirely.  
Link: <https://www.csoonline.com/article/3138934/bgp-errors-are-to-blame-for-monday-s-twitter-outage-not-ddos-attacks.html>

The intent of this upload is to provide a beginning concept for regulating PoE lighting when it involves emergency egress, life safety, or critical branch power. I understand this is not currently written exactly how code is written, but I am hoping the committee can adjust to make it appropriate.

Thank you for your consideration of this. Please let me know any questions.



## Public Input No. 2105-NFPA 70-2023 [ Section No. 517.30(C) ]

### (C) Location of EES Components.

EES components shall be located to minimize interruptions caused by natural forces common to the area (e.g., storms, floods, earthquakes, or hazards created by adjoining structures or activities). [99:6.2.4.1]

#### (1) Services.

Installation of electrical service distribution equipment shall be located to reduce possible interruption of normal electrical services resulting from natural or manmade causes as well as internal wiring and equipment failures.

#### (2) Feeders.

Feeders shall be located to provide physical separation of the feeders of the alternate source and from the feeders of the normal electrical source to prevent possible simultaneous interruption. [99:6.2.4.3]

#### (3) Energy Storage Systems (ESSs).

ESSs shall be located to provide adequate physical separation of the ESS units from the essential distribution system and other on-site energy sources to prevent possible simultaneous interruption.

Informational Note: Facilities in which the normal source of power is supplied by two or more separate central station-fed services experience greater than normal electrical service reliability than those with only a single feed. Such a dual source of normal power consists of two or more electrical services fed from separate generator sets or a utility distribution network that has multiple power input sources and is arranged to provide mechanical and electrical separation so that a fault between the facility and the generating sources is not likely to cause an interruption of more than one of the facility service feeders.

## Statement of Problem and Substantiation for Public Input

Catastrophic failure of battery storage systems has the potential to affect immediate surroundings with excessive heat. By requiring adequate separation of ESS's from the essential distribution systems and other on-site energy resources we will avoid the domino effect of multiple elements of the Essential Electrical system being disabled in the event of a battery fire. (The same language is proposed for section 517.41(B))

## Related Public Inputs for This Document

<u>Related Input</u>	<u>Relationship</u>
<a href="#">Public Input No. 2151-NFPA 70-2023 [Section No. 517.41(B)]</a>	
<a href="#">Public Input No. 2151-NFPA 70-2023 [Section No. 517.41(B)]</a>	

## Submitter Information Verification

**Submitter Full Name:** Jamie Schnick  
**Organization:** OSHPD/HCAI



**Affiliation:** Office of Hospitals Planning and Development/Department of  
Healthcare Access and Information – California

**Street Address:**

**City:**

**State:**

**Zip:**

**Submittal Date:** Sat Aug 12 07:29:34 EDT 2023

**Committee:** NEC-P15



## Public Input No. 2850-NFPA 70-2023 [ Section No. 517.30(C) ]

### (C)– Part I

#### **517.3** Location of ~~EES- Electrical System~~ Components.

~~EES- Electrical system~~ components shall be located to minimize interruptions caused by natural forces common to the area (~~e.g., storms, floods, earthquakes, or hazards created by adjoining structures or activities~~) or natural disasters identified in the facility's emergency operations plan . [99:6.2.4.1]

#### (~~4 A~~) Services.

Installation of electrical ~~service distribution equipment~~ sources shall be located to reduce possible interruption of ~~normal electrical services~~ systems resulting from natural or ~~manmade causes as well as internal~~ forces and to reduce possible disruption of electrical systems due to internal wiring and equipment failures. [99:6.2.4.2]

#### (~~2 B~~) Feeders.

Feeders and associated raceways serving essential electrical system transfer equipment shall be located to ~~provide~~ such that physical separation is provided between each of the ~~feeders of the alternate source and from the feeders of the normal electrical source~~ electrical system feeders to prevent possible simultaneous interruption. [99:6.2.4.3]

Informational Note: Facilities in which the ~~normal~~ off-site source of power is supplied by two or more separate central station-fed services experience greater ~~than normal~~ electrical service reliability than those with only a single feed. Such a dual source of ~~normal~~ power consists of two or more electrical services fed from separate ~~generator sets~~ on-site sources or a utility distribution network that has multiple power input sources and is arranged to provide mechanical and electrical separation so that a fault between the facility and the ~~generating~~ power sources is not likely to cause an interruption of more than one of the facility service feeders.

## Statement of Problem and Substantiation for Public Input

This public input is submitted on behalf of the Microgrid Task Group formed under the direction of the ELS Committee of NFPA 99 to provide correlation input to CMP-15 related to the use of microgrids and distributed energy resources in health care. The TG is also providing public inputs for consideration on any extracted language from 99 that has been modified in the 2024 edition of NFPA 99.

Existing extracted language in 517.30(C) pertaining to Location of EES Components was updated to match 2024 NFPA 99. The extraction text actually deals will location of ALL electrical components and not just EES components. Therefore, the recommendation is to relocate this into Part I General. The Info Note language was altered to move away from terms "alternate" and "normal" source in favor of "on-site" and "off-site" to support the application of various types and configurations of sources.

## Related Public Inputs for This Document

<u>Related Input</u>	<u>Relationship</u>
Public Input No. 2992-NFPA 70-2023 [Section No. 517.41(B)]	

## Submitter Information Verification

**Submitter Full Name:** Chris Finen

**Organization:** Eaton Corporation

**Street Address:**

**City:**

**State:**

**Zip:**

**Submittal Date:** Fri Aug 25 15:09:37 EDT 2023

**Committee:** NEC-P15



## Public Input No. 2973-NFPA 70-2023 [ Section No. 517.31(A) ]

### (A) Separate Branches.

Type 1 essential electrical systems shall be comprised of three separate branches capable of supplying a limited amount of lighting and power service that is considered essential for life safety and effective hospital operation during the time the normal electrical service is interrupted for any reason. The three branches are life safety, critical, and equipment.

The division between the branches shall occur at transfer switches where more than one transfer switch is required. [99:6.7.2.3 2 .1]

### Statement of Problem and Substantiation for Public Input

This public input is submitted on behalf of the Microgrid Task Group formed under the direction of the ELS Committee of NFPA 99 to provide correlation input to CMP-15 related to the use of microgrids and distributed energy resources in health care. The TG is also providing public inputs for consideration on any extracted language from 99 that has been modified in the 2024 edition of NFPA 99.

Extraction reference needs to be updated to the correct location in 2024 NFPA 99.

### Submitter Information Verification

**Submitter Full Name:** Chris Finen

**Organization:** Eaton Corporation

**Street Address:**

**City:**

**State:**

**Zip:**

**Submittal Date:** Mon Aug 28 13:51:24 EDT 2023

**Committee:** NEC-P15



## Public Input No. 3551-NFPA 70-2023 [ Section No. 517.31(A) ]

### (A) Separate Branches.

Type 1 essential electrical systems shall be comprised of three separate branches capable of supplying a limited amount of lighting and power service that is considered essential for life safety and effective hospital operation- ~~during the time the normal electrical service is interrupted for any reason~~ . The three branches are life safety, critical, and equipment branches .

The division between the branches shall occur at transfer switches where more than one transfer switch is required. [99:6.7.2.3.1]

### Statement of Problem and Substantiation for Public Input

NFPA 99 has eliminated the term "normal" for healthcare facilities.

### Submitter Information Verification

**Submitter Full Name:** Walter Vernon

**Organization:** Mazzetti

**Street Address:**

**City:**

**State:**

**Zip:**

**Submittal Date:** Mon Sep 04 19:28:09 EDT 2023

**Committee:** NEC-P15



## Public Input No. 2142-NFPA 70-2023 [ Section No. 517.31(B)(1) ]

### (1) Optional Loads.

Loads served by the ~~generating equipment not on-site resources~~ (energy sources and stored energy power supply systems) not specifically named in this article shall be served by their own transfer switches such that the following conditions apply:

- (1) These loads shall not be transferred if the transfer will overload the ~~generating equipment energy producing equipment and/or storage units~~.
- (2) These loads shall be automatically shed upon ~~generating equipment overloading~~ - energy producing equipment and/or storage units overloading.

### Statement of Problem and Substantiation for Public Input

This language is not consistent with recent changes to the code that allows other energy producing equipment for the Essential Electrical System source. Existing language in the code identifies only generators as the EES source, but 517.30 lists other options. Based on recent changes to the code, this should be replaced with language that addresses all on site energy producers and storage units.

### Submitter Information Verification

**Submitter Full Name:** Jamie Schnick  
**Organization:** OSHPD/HCAI  
**Affiliation:** Office of Hospitals Planning and Development/Department of Healthcare Access and Information – California  
**Street Address:**  
**City:**  
**State:**  
**Zip:**  
**Submittal Date:** Sun Aug 13 01:55:25 EDT 2023  
**Committee:** NEC-P15



## Public Input No. 3556-NFPA 70-2023 [ Section No. 517.31(B)(1) ]

### (1) Optional Loads.

Loads ~~served by the generating equipment~~ not specifically named in this article to be served by the essential electrical system are not permitted to be connected to the essential electrical system. If these loads are served by the on-site generation source or set of sources providing power to the essential electrical system, they shall be served by their own transfer switches such that the following conditions apply:

- (1) These loads shall not be transferred if the transfer will overload the ~~generating equipment~~ on-site source or set of sources .
- (2) These loads shall be automatically shed upon ~~generating equipment overloading~~ on-site source(s) overloading .

### Statement of Problem and Substantiation for Public Input

This is necessary because a generating unit is not the only potential on-site service for the essential electrical system.

### Submitter Information Verification

**Submitter Full Name:** Walter Vernon

**Organization:** Mazzetti

**Street Address:**

**City:**

**State:**

**Zip:**

**Submittal Date:** Mon Sep 04 19:35:27 EDT 2023

**Committee:** NEC-P15



## Public Input No. 3006-NFPA 70-2023 [ Section No. 517.31(B)(2) ]

### (2) Contiguous Facilities.

~~Hospital power sources and alternate power sources shall.~~ Power sources for Type 1 EES shall be permitted to serve the essential electrical systems of contiguous or same-site facilities.

### Statement of Problem and Substantiation for Public Input

This public input is submitted on behalf of the Microgrid Task Group formed under the direction of the ELS Committee of NFPA 99 to provide correlation input to CMP-15 related to the use of microgrids and distributed energy resources in health care. The TG is also providing public inputs for consideration on any extracted language from 99 that has been modified in the 2024 edition of NFPA 99.

To support the use of various types of power sources, distributed energy resources, and microgrids, the terms "alternate" and "normal" need to be replaced with more generic terms for power sources such as "on-site" and "off-site". Word "hospital" was removed so that this requirement applies to any health care facility type with Type 1 EES.

### Submitter Information Verification

**Submitter Full Name:** Chris Finen

**Organization:** Eaton Corporation

**Street Address:**

**City:**

**State:**

**Zip:**

**Submittal Date:** Mon Aug 28 16:32:47 EDT 2023

**Committee:** NEC-P15





## Public Input No. 3590-NFPA 70-2023 [ Section No. 517.31(B)(2) ]

### (2) Contiguous Facilities.

Hospital power ~~sources and alternate power sources shall~~ sources shall be permitted to serve the essential electrical systems of contiguous or same-site facilities.

### Statement of Problem and Substantiation for Public Input

this provision applies to all sources, not just the "alternate" sources. Also, now that i read this, we should move it up to 517.2.

### Submitter Information Verification

**Submitter Full Name:** Walter Vernon

**Organization:** Mazzetti

**Street Address:**

**City:**

**State:**

**Zip:**

**Submittal Date:** Mon Sep 04 22:35:52 EDT 2023

**Committee:** NEC-P15



**Public Input No. 2109-NFPA 70-2023 [ Section No. 517.31(B) [Excluding any Sub-Sections] ]**

A large, empty rectangular box with a thin border, intended for public input or comments.

Transfer switches shall be in accordance with one of the following:

- (1) The number of transfer switches to be used shall be based on reliability and design. Each branch of the essential electrical system shall have one or more transfer switches.
- (2) One transfer switch shall be permitted to serve one or more branches in a facility with a continuous load ~~on the switch of~~ essential electrical system load of 150 kVA (120 kW) or less. [99:6.7.6.2.1.4]

Informational Note No. 1: See NFPA 99-2021, *Health Care Facilities Code*, 6.7.3.1, 6.7.2.2.5, 6.7.2.2.5.15, and 6.7.2.2.7, for more information on transfer switches.

Informational Note No. 2: See Informational Note Figure 517.31(B)(1).

Informational Note No. 3: See Informational Note Figure 517.31(B)(2).

**Figure Informational Note Figure 517.31(B)(1) Type 1 Essential Electrical System — Minimum Requirement (Greater Than 150 kVA) for Transfer Switch Arrangement.**

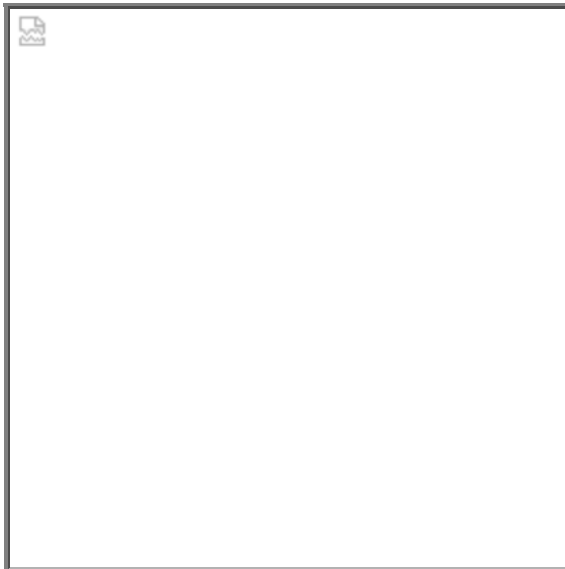

**Figure Informational Note Figure 517.31(B)(2) Type 1 Essential Electrical System — Minimum Requirement (150 kVA or Less) for Transfer Switch Arrangement.**

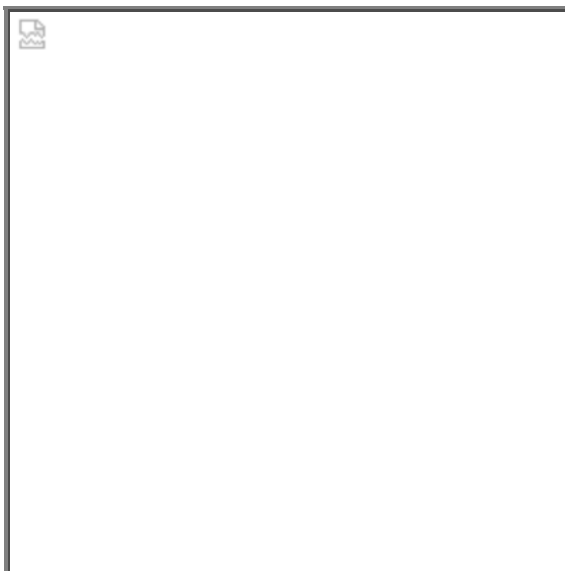

## Statement of Problem and Substantiation for Public Input

There is a potential for this to be misinterpreted. By stating that the threshold for requiring multiple

transfer switches is the facilities essential electrical system load, it clarifies that the individual ATS sizing does not drive the need for multiple ATSS but the overall EES load is the driving factor. It appears that this was the intent of the code section as written. We recommend this change to avoid confusion on code interpretation. (Similar to 2110 for SNF's)

## Related Public Inputs for This Document

<u>Related Input</u>	<u>Relationship</u>
<a href="#">Public Input No. 2110-NFPA 70-2023 [Section No. 517.42(B)]</a>	
<a href="#">Public Input No. 2110-NFPA 70-2023 [Section No. 517.42(B)]</a>	

## Submitter Information Verification

**Submitter Full Name:** Jamie Schnick  
**Organization:** OSHPD/HCAI  
**Affiliation:** Office of Hospitals Planning and Development/Department of Healthcare Access and Information – California  
**Street Address:**  
**City:**  
**State:**  
**Zip:**  
**Submittal Date:** Sat Aug 12 08:11:19 EDT 2023  
**Committee:** NEC-P15



**Public Input No. 2975-NFPA 70-2023 [ Section No. 517.31(B) [Excluding any Sub-Sections] ]**

A large, empty rectangular box with a thin border, intended for public input or comments.

Transfer switches shall be in accordance with one of the following:

- (1) The number of transfer switches to be used shall be based on reliability and design. Each branch of the essential electrical system shall have one or more transfer switches.
- (2) One transfer switch shall be permitted to serve one or more branches in a facility with a continuous load on the switch of 150 kVA (120 kW) or less. [99:6.7.6.2.1.4]

Informational Note No. 1: See NFPA 99-2021, *Health Care Facilities Code*, 6.7.3.2.1.3, 6.7.2.2.1.5.4, 6.7.2.2.1.5.45, and 6.7.2.2.1.6, and 6.7.3.1, for more information on transfer switches.

Informational Note No. 2: See Informational Note Figure 517.31(B)(1).

Informational Note No. 3: See Informational Note Figure 517.31(B)(2).

**Figure Informational Note Figure 517.31(B)(1) Type 1 Essential Electrical System — Minimum Requirement (Greater Than 150 kVA) for Transfer Switch Arrangement.**

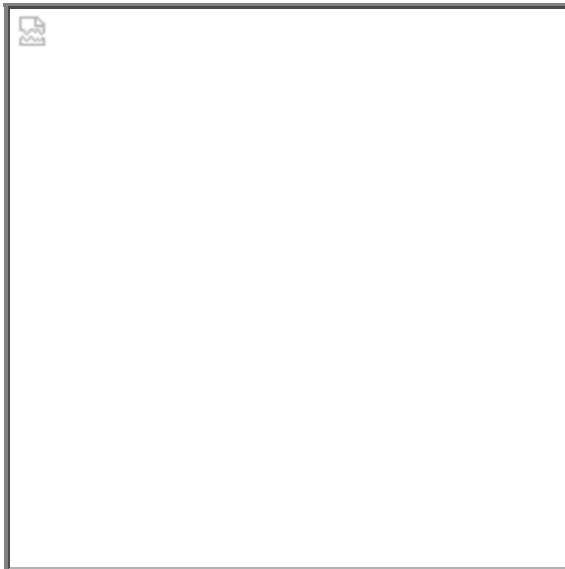

**Figure Informational Note Figure 517.31(B)(2) Type 1 Essential Electrical System — Minimum Requirement (150 kVA or Less) for Transfer Switch Arrangement.**

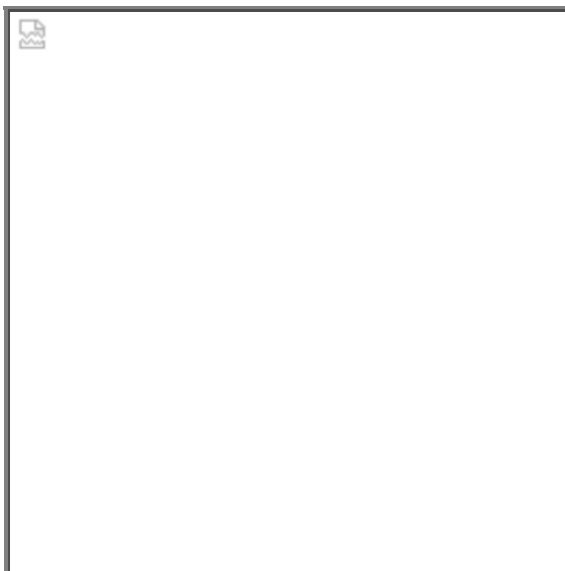

## Statement of Problem and Substantiation for Public Input

This public input is submitted on behalf of the Microgrid Task Group formed under the direction of the

ELS Committee of NFPA 99 to provide correlation input to CMP-15 related to the use of microgrids and distributed energy resources in health care. The TG is also providing public inputs for consideration on any extracted language from 99 that has been modified in the 2024 edition of NFPA 99.

Info note references point to info in 99 that is not related to transfer switches. Updated the references to point to the following locations in 99 related to transfer switches:

6.7.2.1.3 Automatic Transfer Switch Features

6.7.2.1.4 Nonautomatic Transfer Device Classification

6.7.2.1.5 Nonautomatic Transfer Device Features

6.7.2.1.6 Bypass and Isolating Transfer Switches

6.7.3 Performance Criteria and Testing.

6.7.3.1 Transfer Switches.

## Submitter Information Verification

**Submitter Full Name:** Chris Finen

**Organization:** Eaton Corporation

**Street Address:**

**City:**

**State:**

**Zip:**

**Submittal Date:** Mon Aug 28 13:54:47 EDT 2023

**Committee:** NEC-P15



**Public Input No. 3553-NFPA 70-2023 [ Section No. 517.31(B) [Excluding any Sub-Sections] ]**

[Empty comment box]



Transfer switches shall be in accordance with one of the following:

- (1) The number of transfer switches to be used shall be based on reliability and design. Each branch of the essential electrical system shall have one or more transfer switches.
- (2) ~~One transfer switch shall be permitted to serve one or more branches in~~ In a facility with a ~~continuous load~~ maximum actual demand on the switch of 150 kVA (120 kW essential electrical system of 150 kVA (120kW ) or less. [ ~~99: 6.7.6.2.1.4~~ ], one transfer switch and distribution equipment shall be permissible. These facilities do not require three branches of power for the system.

Informational Note No. 1: See NFPA 99-2021, *Health Care Facilities Code*, 6.7.3.1, 6.7.2.2.5, 6.7.2.2.5.15, and 6.7.2.2.7, for more information on transfer switches.

Informational Note No. 2: See Informational Note Figure 517.31(B)(1) .

Informational Note No. 3: See Informational Note Figure 517.31(B)(2) .

**Figure Informational Note Figure 517.31(B)(1) Type 1 Essential Electrical System — Minimum Requirement (Greater Than 150 kVA) for Transfer Switch Arrangement.**

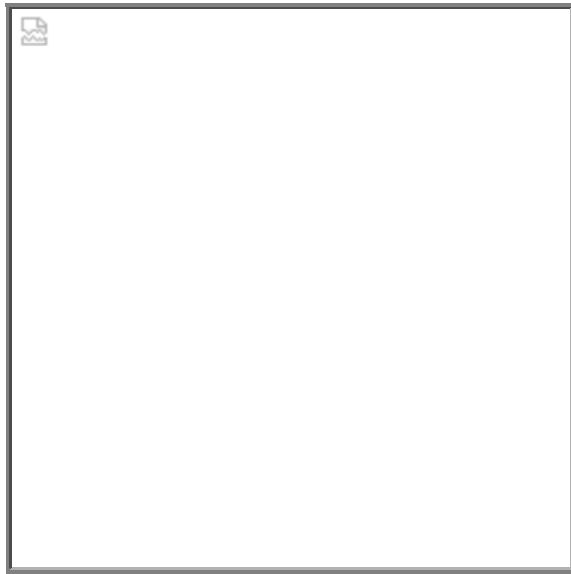

**Figure Informational Note Figure 517.31(B)(2) Type 1 Essential Electrical System — Minimum Requirement (150 kVA or Less) for Transfer Switch Arrangement.**

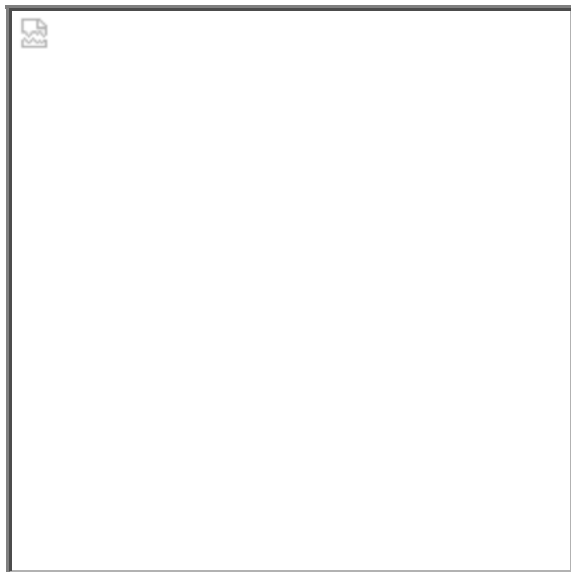

## Statement of Problem and Substantiation for Public Input

This PI includes two important changes. The first restates the one transfer switch rule with a better description of the capacity, and the recognition that one "branch" is sufficient for these small facilities.

The second change eliminates the diagrams in favor of the one proposed in PI 2515.

## Related Public Inputs for This Document

<u>Related Input</u>	<u>Relationship</u>
<a href="#">Public Input No. 2515-NFPA 70-2023 [New Section after 517.1]</a>	2515 includes the proposed new diagram.

## Submitter Information Verification

**Submitter Full Name:** Walter Vernon  
**Organization:** Mazzetti  
**Street Address:**  
**City:**  
**State:**  
**Zip:**  
**Submittal Date:** Mon Sep 04 19:30:14 EDT 2023  
**Committee:** NEC-P15



## Public Input No. 2144-NFPA 70-2023 [ Section No. 517.31(C)(3) ]

### (3) Mechanical Protection of the Essential Electrical System.

The wiring of the life safety and critical branches shall be mechanically protected by raceways. Where installed as branch circuits in patient care spaces, the installation shall comply with the requirements of 517.13(A) and (B) and 250.118. Only the following wiring methods shall be permitted:

- (1) Nonflexible metal raceways, Type MI cable, RTRC marked with the suffix -XW, or Schedule 80 PVC conduit. Nonmetallic raceways shall not be used for branch circuits that supply patient care spaces.
- (2) Where encased in not less than 50 mm (2 in.) of concrete, Schedule 40 PVC conduit, flexible nonmetallic or jacketed metallic raceways, or jacketed metallic cable assemblies listed for installation in concrete. Nonmetallic raceways shall not be used for branch circuits that supply patient care spaces.
- (3) Listed flexible metal raceways and listed metal sheathed cable assemblies, as follows:
  - (4) Where used in listed prefabricated medical headwalls
  - (5) In listed office furnishings
  - (6) Where fished into existing walls or ceilings, not otherwise accessible and not subject to physical damage
  - (7) Where necessary for flexible connection to equipment
  - (8) For equipment that requires a flexible connection due to movement, vibration, or operation
  - (9) From Luminaires installed in ceiling structures to an outlet box placed at least 300 mm (1 ft) from the luminaire but no more than 1.8 m (6 ft) in length.
- (10) Flexible power cords of appliances or other utilization equipment connected to the essential electrical system.
- (11) Cables for Class 2 or Class 3 systems permitted in Part VI of this article, with or without raceways.

Informational Note: See 517.13 for additional grounding requirements in patient care areas.

### Statement of Problem and Substantiation for Public Input

The current language in the code is confusing. It is not clear if the intention is that critical and life safety branch circuiting for luminaires can utilize:

- 1) Listed flexible metal raceways (FMC) or listed metal sheathed cable assemblies (AC/MC) for the entire circuit (including daisy chaining wiring between fixtures)  
- or-
- 2) FMC and A/MC for fixture whips only (installed as part of the building wiring system)  
-or-
- 3) If the use of FMC or AC/MC cables are limited to that product that is provided as part of the fixture. (ie fixture provided whips and internal wiring)

Based on our previous understanding of the code we are suggesting language that limits the use of FMC and AC/MC cables to fixture whips only and are providing guidance on maximum length of

flexible conduit as called out in 410.117.

(Note only item (f) luminaires installed in ceiling structures is modified and should be underlined - formatting issue)

### Submitter Information Verification

**Submitter Full Name:** Jamie Schnick

**Organization:** OSHPD/HCAI

**Affiliation:** Office of Hospitals Planning and Development/Department of Healthcare Access and Information – California

**Street Address:**

**City:**

**State:**

**Zip:**

**Submittal Date:** Sun Aug 13 09:55:05 EDT 2023

**Committee:** NEC-P15



## Public Input No. 3791-NFPA 70-2023 [ Section No. 517.31(C)(3) ]

### (3) Mechanical Protection of the Essential Electrical System.

The wiring of the life safety and critical branches shall be mechanically protected by raceways. Where installed as branch circuits in patient care spaces, the installation shall comply with the requirements of 517.13(A) and (B) and 250.118. Only the following wiring methods shall be permitted:

- (1) Nonflexible metal raceways, Type MI cable, and Type MC, RTRC marked with the suffix -XW, or Schedule 80 PVC conduit. Nonmetallic raceways shall not be used for branch circuits that supply patient care spaces.
- (2) Where encased in not less than 50 mm (2 in.) of concrete, Schedule 40 PVC conduit, flexible nonmetallic or jacketed metallic raceways, or jacketed metallic cable assemblies listed for installation in concrete. Nonmetallic raceways shall not be used for branch circuits that supply patient care spaces.
- (3) Listed flexible metal raceways and listed metal sheathed cable assemblies, as follows:
  - (4) Where used in listed prefabricated medical headwalls
  - (5) In listed office furnishings
  - (6) Where fished into existing walls or ceilings, not otherwise accessible and not subject to physical damage
  - (7) Where necessary for flexible connection to equipment
  - (8) For equipment that requires a flexible connection due to movement, vibration, or operation
  - (9) Luminaires installed in ceiling structures
- (10) Flexible power cords of appliances or other utilization equipment connected to the essential electrical system.
- (11) Cables for Class 2 or Class 3 systems permitted in Part VI of this article, with or without raceways.

Informational Note: See 517.13 for additional grounding requirements in patient care areas.

### Statement of Problem and Substantiation for Public Input

Type MC cable is listed by passing UL 1569 requirements, which require crush resistance and impact testing for all cables: 1000 lbf minimum on 14 AWG conductors, and 2000 lbf minimum on 2 AWG conductors; impact is tested by dropping a 10 lb steel block on 14 AWG conductors and 50 lbs steel block on 2 AWG conductor.

For MI cable, there is only an optional crush test on the UL standard that supports type MI cable (UL 504) for the jacketed version. There is only an optional impact test in UL 504 for impact at -40C temperature. Additionally, the UL 504 crushing requirement is only 1000 lbf and it does not specify conductor size, it is optional and only applicable to jacketed cables. The UL 504 requirement for impact test is also optional and only available for the jacketed cables, lacking impact weight criteria.

Based on equitable and impartial standards requirements, Type MC cables are subject to a higher level of crush and impact testing than MI cable, which is already allowed in this application. Therefore, it is proposed that Type MC cables be permitted in this application.

### Submitter Information Verification

**Submitter Full Name:** Alex Marciano

**Organization:** Marmon IEI

**Street Address:**

**City:**

**State:**

**Zip:**

**Submittal Date:** Tue Sep 05 16:30:35 EDT 2023

**Committee:** NEC-P15



## Public Input No. 4052-NFPA 70-2023 [ Section No. 517.31(C)(3) ]

### (3) Mechanical Protection of the Essential Electrical System.

The wiring of the life safety and critical branches shall be mechanically protected by raceways. Where installed as branch circuits in patient care spaces, the installation shall comply with the requirements of 517.13(A) and (B) and 250.118. Only the following wiring methods shall be permitted in patient care spaces :

- (1) Nonflexible metal raceways, Type MI cable, RTRC marked with the suffix -XW, or Schedule 80 PVC conduit. Nonmetallic raceways shall not be used for branch circuits that supply patient care spaces.
- (2) Where encased in not less than 50 mm (2 in.) of concrete, Schedule 40 PVC conduit, flexible nonmetallic or jacketed metallic raceways, or jacketed metallic cable assemblies listed for installation in concrete. Nonmetallic raceways shall not be used for branch circuits that supply patient care spaces.
- (3) Listed flexible metal raceways and listed metal sheathed cable assemblies, as follows:
  - (4) Where used in listed prefabricated medical headwalls
  - (5) In listed office furnishings
  - (6) Where fished into existing walls or ceilings, not otherwise accessible and not subject to physical damage
  - (7) Where necessary for flexible connection to equipment
  - (8) For equipment that requires a flexible connection due to movement, vibration, or operation
  - (9) Luminaires installed in ceiling structures
- (10) Flexible power cords of appliances or other utilization equipment connected to the essential electrical system.
- (11) Cables for Class 2 or Class 3 systems permitted in Part VI of this article, with or without raceways.

Informational Note: See 517.13 for additional grounding requirements in patient care areas.

### Statement of Problem and Substantiation for Public Input

The language with multiple sentences here is confusing. It is my understanding that the intent of the code is that wiring methods listed below would be limited to patient care areas. This addition should help eliminate confusion.

### Submitter Information Verification

**Submitter Full Name:** Jamie Schnick

**Organization:** OSHPD/HCAI

**Street Address:**

**City:**

**State:**

**Zip:**

**Submittal Date:** Wed Sep 06 14:59:40 EDT 2023

**Committee:** NEC-P15





## Public Input No. 4065-NFPA 70-2023 [ Section No. 517.31(C)(3) ]

### (3) Mechanical Protection of the Essential Electrical System.

The wiring of the life safety and critical branches shall be mechanically protected by raceways. Where installed as branch circuits in patient care spaces, the installation shall comply with the requirements of 517.13(A) and (B) and 250.118. Only the following wiring methods shall be permitted:

- (1) Nonflexible metal raceways, Type MI cable, RTRC marked with the suffix -XW, or Schedule 80 PVC conduit. Nonmetallic raceways shall not be used for branch circuits that supply patient care spaces.
- (2) Where encased in not less than 50 mm (2 in.) of concrete, Schedule 40 PVC conduit, flexible nonmetallic or jacketed metallic raceways, or jacketed metallic cable assemblies listed for installation in concrete. Nonmetallic raceways shall not be used for branch circuits that supply patient care spaces.

Exceptions: The following exceptions shall be permitted:

- (1) Listed flexible metal raceways and listed metal sheathed cable assemblies, as follows:
  - (2) Where used in listed prefabricated medical headwalls
  - (3) In listed office furnishings
  - (4) Where fished into existing walls or ceilings, not otherwise accessible and not subject to physical damage
  - (5) Where necessary for flexible connection to equipment
  - (6) For equipment that requires a flexible connection due to movement, vibration, or operation
  - (7) Luminaires installed in ceiling structures
- (8) Flexible power cords of appliances or other utilization equipment connected to the essential electrical system.
- (9) Cables for Class 2 or Class 3 systems permitted in Part VI of this article, with or without raceways.

Informational Note: See 517.13 for additional grounding requirements in patient care areas.

### Statement of Problem and Substantiation for Public Input

The listing of acceptable methods for mechanical protection is a bit confusing, as the items previously listed as items 4-6 appear to be exceptions. The proposed revision could help to clarify.

### Submitter Information Verification

**Submitter Full Name:** Jamie Schnick

**Organization:** OSHPD/HCAI

**Street Address:**

**City:**

**State:**

**Zip:**

**Submittal Date:** Wed Sep 06 15:30:11 EDT 2023

**Committee:** NEC-P15



## Public Input No. 4156-NFPA 70-2023 [ Section No. 517.31(C)(3) ]

### (3) Mechanical Protection of the Essential Electrical System.

The wiring of the life safety and critical branches shall be mechanically protected by raceways. Where installed as branch circuits in patient care spaces, the installation shall comply with the requirements of 517.13(A) and (B) and 250.118. Only the following wiring methods shall be permitted:

- (1) Nonflexible metal raceways, Type MI cable, RTRC marked with the suffix -XW, or Schedule 80 PVC conduit. Nonmetallic raceways shall not be used for branch circuits that supply patient care spaces.
- (2) Where encased in not less than 50 mm (2 in.) of concrete, Schedule 40 PVC conduit, flexible nonmetallic or jacketed metallic raceways, or jacketed metallic cable assemblies listed for installation in concrete. Nonmetallic raceways shall not be used for branch circuits that supply patient care spaces.
- (3) Listed flexible metal raceways and listed metal sheathed cable assemblies, as follows:
  - (4) Where used in listed prefabricated medical headwalls
  - (5) In listed office furnishings
  - (6) Where fished into existing walls or ceilings, not otherwise accessible and not subject to physical damage
  - (7) Where necessary for flexible connection to equipment
  - (8) For equipment that requires a flexible connection due to movement, vibration, or operation
  - (9) Luminaires installed in ceiling structures
- (10) Flexible power cords of appliances or other utilization equipment connected to the essential electrical system.
- (11) Cables for Class 2, Class 3, or Class 3 ~~Class 3~~ Class 4 systems permitted in Part VI of this article, with or without raceways.

Informational Note: See 517.13 for additional grounding requirements in patient care areas.

### Statement of Problem and Substantiation for Public Input

Adding Class 4 to the list. Class 4 systems were added in the 2023 code and have equivalent or better than fire and life safety requirements as Class 2 circuits. An effort to analyze all the locations of Class 2 in the code to see if Class 4 was also appropriate in the application should have happened for the 2023 code and not doing it was an oversight.

### Submitter Information Verification

**Submitter Full Name:** Chad Jones

**Organization:** Cisco Systems

**Street Address:**

**City:**

**State:**

**Zip:**

**Submittal Date:** Wed Sep 06 19:01:01 EDT 2023

**Committee:** NEC-P15



## Public Input No. 2749-NFPA 70-2023 [ Section No. 517.31(D) ]

### (D) Capacity of Systems.

The essential electrical system shall have the capacity and rating to meet the maximum actual demand likely to be produced by the connected load.

Feeders shall be sized in accordance with 215.2 and ~~Part III of~~ Article 220 , Part III . The alternate power source(s) required in 517.30 shall have the capacity and rating to meet the demand produced by the load at any given time.

Demand calculations for sizing of the alternate power source(s) shall be based on any of the following:

- (1) Prudent demand factors and historical data
- (2) Connected load
- (3) Feeder calculations
- (4) Any combination of the above

The sizing requirements in 700.4 and 701.4 shall not apply to alternate sources.

### Statement of Problem and Substantiation for Public Input

This Public Input is being submitted on behalf of the NEC Correlating Committee Usability Task Group in order to provide correlation throughout the document. The text is revised to to comply with the NEC Style Manual Section 4.1.4, regarding the use of Parts.

4.1.4 References to an Entire Article. References shall not be made to an entire article, except for the Article 100 or where referenced to provide the necessary context. References to specific parts within articles shall be permitted. References to all parts of an article shall not be permitted. The article number shall precede the part number.

The Usability Task Group members are: Derrick Atkins, David Hittinger, Richard Holub, Dean Hunter, Chad Kennedy and David Williams.

### Submitter Information Verification

**Submitter Full Name:** David Williams

**Organization:** Delta Charter Township

**Street Address:**

**City:**

**State:**

**Zip:**

**Submittal Date:** Thu Aug 24 19:54:49 EDT 2023

**Committee:** NEC-P15



## Public Input No. 3019-NFPA 70-2023 [ Section No. 517.31(D) ]

### (D) Capacity of Systems.

The essential electrical system shall have the capacity and rating to meet the maximum actual demand likely to be produced by the connected load.

Feeders shall be sized in accordance with 215.2 and Part III of Article 220. The ~~alternate on-site~~ power source(s) required in 517.30 shall have the capacity and rating to meet the demand produced by the load at any given time.

Demand calculations for sizing of the ~~alternate on-site~~ power source(s) shall be based on any of the following:

- (1) Prudent demand factors and historical data
- (2) Connected load
- (3) Feeder calculations
- (4) Any combination of the above

The sizing requirements in 700.4 and 701.4 shall not apply to ~~alternate~~ essential electrical system power sources.

### Statement of Problem and Substantiation for Public Input

This public input is submitted on behalf of the Microgrid Task Group formed under the direction of the ELS Committee of NFPA 99 to provide correlation input to CMP-15 related to the use of microgrids and distributed energy resources in health care. The TG is also providing public inputs for consideration on any extracted language from 99 that has been modified in the 2024 edition of NFPA 99.

To support the use of various types of power sources, distributed energy resources, and microgrids, the terms "alternate" and "normal" need to be replaced with more generic terms for power sources such as "on-site" and "off-site".

### Submitter Information Verification

**Submitter Full Name:** Chris Finen

**Organization:** Eaton Corporation

**Street Address:**

**City:**

**State:**

**Zip:**

**Submittal Date:** Mon Aug 28 17:30:28 EDT 2023

**Committee:** NEC-P15



## Public Input No. 3593-NFPA 70-2023 [ Section No. 517.31(D) ]

### ~~(D)– Capacity of Systems.~~

~~The essential electrical system shall have the capacity and rating to meet the maximum actual demand likely to be produced by the connected load.~~

~~Feeders shall be sized in accordance with 215.2 and Part III of Article 220 .The alternate power source(s) required in 517.30 shall have the capacity and rating to meet the demand produced by the load at any given time.~~

~~Demand calculations for sizing of the alternate power source(s) shall be based on any of the following:~~

- ~~(1) Prudent demand factors and historical data~~
- ~~(2) Connected load~~
- ~~(3) Feeder calculations~~
- ~~(4) Any combination of the above~~

~~The sizing requirements in 700.4 and 701.4 shall not apply to alternate sources.~~

### Statement of Problem and Substantiation for Public Input

This language should apply to both essential and non-essential systems. Thus, i suggest moving it into new 517-2.

### Related Public Inputs for This Document

<u>Related Input</u>	<u>Relationship</u>
<u>Public Input No. 2515-NFPA 70-2023 [New Section after 517.1]</u>	2515 is taking the place of this text

### Submitter Information Verification

**Submitter Full Name:** Walter Vernon  
**Organization:** Mazzetti  
**Street Address:**  
**City:**  
**State:**  
**Zip:**  
**Submittal Date:** Tue Sep 05 05:23:28 EDT 2023  
**Committee:** NEC-P15



## Public Input No. 1035-NFPA 70-2023 [ Section No. 517.31(E) ]

### (E) Receptacle Identification.

The electrical receptacles or the cover plates for the electrical receptacles supplied from the life safety shall be in yellow, and critical branches shall ~~have a distinctive color or marking~~ be in orange marking so as to be readily identifiable. [99:6.7.2.2.5(B)]

### Statement of Problem and Substantiation for Public Input

Painting, taping or other means to identify life safety and critical branch is very important in hospital. By keeping the colors of the critical branches orange and life safety in yellow thru out the code in at the location of the installation, hospital electrical personal will understand not to enter devices, junction boxes, and panelboard to install electrical that is not related to the life safety and critical branches of the electrical system.

In Portsmouth NH we had a electrical heater in a office that was on the critical branch and it tripped the overcurrent device for the patient bed area.

The electrician went above the ceiling found a blue painted junction box and connected the 120 volt electrical heater to it.

By making colors manditory this should not have happen, with code updates every 3 years.

### Submitter Information Verification

**Submitter Full Name:** John Plourde

**Organization:** Portsmouth Nh City Of

**Affiliation:** Performance Electrical Training LLC.

**Street Address:**

**City:**

**State:**

**Zip:**

**Submittal Date:** Mon Jun 12 13:56:07 EDT 2023

**Committee:** NEC-P15





## Public Input No. 3004-NFPA 70-2023 [ Section No. 517.31(F) ]

### (F) Feeders from Alternate- Power Source(s) .

A single feeder supplied by a ~~local or remote alternate~~ on-site or off-site power source shall be permitted to supply the essential electrical system to the point at which the life safety, critical, and equipment branches are separated. Installation of the transfer equipment shall be permitted at other than the location of ~~the alternate power~~ the power source.

### Statement of Problem and Substantiation for Public Input

This public input is submitted on behalf of the Microgrid Task Group formed under the direction of the ELS Committee of NFPA 99 to provide correlation input to CMP-15 related to the use of microgrids and distributed energy resources in health care. The TG is also providing public inputs for consideration on any extracted language from 99 that has been modified in the 2024 edition of NFPA 99.

To support the use of various types of power sources, distributed energy resources, and microgrids, the terms "alternate" and "normal" need to be replaced with more generic terms such as "on-site" and "off-site".

### Submitter Information Verification

**Submitter Full Name:** Chris Finen

**Organization:** Eaton Corporation

**Street Address:**

**City:**

**State:**

**Zip:**

**Submittal Date:** Mon Aug 28 16:04:00 EDT 2023

**Committee:** NEC-P15



## Public Input No. 3594-NFPA 70-2023 [ Section No. 517.31(F) ]

### (F) Feeders from Alternate Power Source.

A single feeder supplied by ~~a local or remote alternate power source~~ a source shall be permitted to supply the essential electrical system to the point at which the life safety, critical, and equipment branches are separated. Installation of the transfer equipment shall be permitted at other than the location of the alternate power source.

### Statement of Problem and Substantiation for Public Input

nfpa 99 eliminated the term alternate power source.

### Submitter Information Verification

**Submitter Full Name:** Walter Vernon

**Organization:** Mazzetti

**Street Address:**

**City:**

**State:**

**Zip:**

**Submittal Date:** Tue Sep 05 05:27:56 EDT 2023

**Committee:** NEC-P15



## Public Input No. 2113-NFPA 70-2023 [ Section No. 517.32 ]

### 517.32 Branches Requiring Automatic Connection.

(A) Life Safety, Critical and Critical Branch- Equipment Branches Used in a Type 1 EES.

1) Those functions of patient care depending on lighting or appliances that are considered essential for life safety, critical patient care, and the effective operation of the health care facility that are connected to the essential electrical system shall be divided into the life safety- branch and the critical branch, critical and equipment branches, as described in 517.33- and - , \_ 517.34 and 517 . 35 .

~~(B) Life Safety and Critical Branch Used in a Type 2 EES.~~

2) The life safety and critical branches shall be installed and connected to the alternate power source specified in 517.

41

30 (A)

and ~~(B)~~ so

so that all functions specified herein for the life safety and critical branches are automatically restored to operation within 10 seconds after interruption of the normal source. [ **99**: 6.7.5.3.1 ]

## Statement of Problem and Substantiation for Public Input

There appear to be 2 problems here that can be resolved with the proposed changes.

1) As the code is currently written, there is no requirement for the Life Safety and Critical Branches in a Type 1 EES to be installed and connected to the alternate power source specified in 517.41(A) and (B) so that all functions specified herein for the life safety and critical branches are automatically restored to operation within 10 seconds after interruption of the normal source.

2) This paragraph (B) as written appears to be in the wrong location in the code (under 517.29 - 517.35 which is dedicated for Type 1 systems that serve Category 1 spaces). Note no need to relocate as 517.43 appears to address this requirement for Type 2 systems that serve Category 2 spaces.

## Submitter Information Verification

**Submitter Full Name:** Jamie Schnick  
**Organization:** OSHPD/HCAI  
**Affiliation:** Office of Hospitals Planning and Development/Department of Healthcare Access and Information – California  
**Street Address:**  
**City:**  
**State:**  
**Zip:**  
**Submittal Date:** Sat Aug 12 09:01:22 EDT 2023  
**Committee:** NEC-P15



## Public Input No. 2978-NFPA 70-2023 [ Section No. 517.32 ]

### 517.32 Branches Requiring Automatic Connection.

#### (A) Life Safety and Critical Branch Used in a Type 1 EES.

Those functions of patient care depending on lighting or appliances that are connected to the essential electrical system shall be divided into the life safety branch and the critical branch, as described in 517.33 and 517.34.

#### (B) Life Safety and Critical Branch Used in a Type 2\_1\_ EES.

The life safety and critical branches shall be installed and connected to the alternate power source specified in 517.41 30 (A) and (B) so so that all functions specified herein for the life safety and critical branches are automatically restored to operation within 10 seconds after interruption of the normal source. [99:6.7.5.3.1]

### Statement of Problem and Substantiation for Public Input

517.32(B) refers to Type 2 EES but should be Type 1 EES. This section of article 517 is for Type 1 EES. Type 2 EES begins at 517.40. Additionally, Type 2 EES do not include a Critical Branch. The reference to the power source was also updated to the Type 1 EES power sources discussed in 517.30(B) rather than the Type 2 power sources discussed in 517.41 (A) and (B).

### Related Public Inputs for This Document

<u>Related Input</u>	<u>Relationship</u>
<a href="#">Public Input No. 2976-NFPA 70-2023 [Section No. 517.32(B)]</a>	

### Submitter Information Verification

**Submitter Full Name:** Chris Finen  
**Organization:** Eaton Corporation  
**Street Address:**  
**City:**  
**State:**  
**Zip:**  
**Submittal Date:** Mon Aug 28 14:05:47 EDT 2023  
**Committee:** NEC-P15



## Public Input No. 2976-NFPA 70-2023 [ Section No. 517.32(B) ]

**(B)** Life Safety and Critical Branch Used in a Type 2 EES.

The life safety and critical branches shall be installed and connected to the ~~alternate~~ on-site power source specified in 517.41(A) and (B) so that all functions specified herein for the life safety and critical branches are automatically restored to operation within 10 seconds after interruption of the ~~normal source power~~ . [99:6.7.5.3.1]

### Statement of Problem and Substantiation for Public Input

This public input is submitted on behalf of the Microgrid Task Group formed under the direction of the ELS Committee of NFPA 99 to provide correlation input to CMP-15 related to the use of microgrids and distributed energy resources in health care. The TG is also providing public inputs for consideration on any extracted language from 99 that has been modified in the 2024 edition of NFPA 99.

Updating term "alternate" with "on-site" and eliminating "normal source" to match extraction language in 99.

### Related Public Inputs for This Document

<u>Related Input</u>	<u>Relationship</u>
<u>Public Input No. 2978-NFPA 70-2023 [Section No. 517.32]</u>	

### Submitter Information Verification

**Submitter Full Name:** Chris Finen  
**Organization:** Eaton Corporation  
**Street Address:**  
**City:**  
**State:**  
**Zip:**  
**Submission Date:** Mon Aug 28 14:00:55 EDT 2023  
**Committee:** NEC-P15



## Public Input No. 1033-NFPA 70-2023 [ Section No. 517.33 ]

### 517.33 Life Safety Branch.

The life safety branch shall be limited to circuits essential to life safety. [99:6.7.5.1.2.3]

No functions other than those listed in 517.33(A) through (H) shall be connected to the life safety branch. The life safety branch must be identified in yellow at every 10 feet at all junction boxes, raceways, panels, and transfer switches. The life safety branch shall supply power as follows:

#### (A) Illumination of Means of Egress.

Illumination of means of egress such as lighting required for corridors, passageways, stairways, and landings at exit doors, and all necessary ways of approach to exits. Switching arrangements to transfer patient corridor lighting in hospitals from general illumination circuits to night illumination circuits shall be permitted, if only one of two circuits can be selected and both circuits cannot be extinguished at the same time.

Informational Note: See NFPA 101-2021, *Life Safety Code*, Sections 7.8 and 7.9.

#### (B) Exit Signs.

Exit signs and exit directional signs.

Informational Note: See NFPA 101-2021, *Life Safety Code*, Section 7.10.

#### (C) Alarm and Alerting Systems.

Alarm and alerting systems including the following:

- (1) Fire alarm systems
- (2) Alarm and alerting systems (other than fire alarm systems) shall be connected to the life safety branch or critical branch. [99:6.7.5.1.2.5]
- (3) Alarms for systems used for the piping of nonflammable medical gases
- (4) Mechanical, control, and other accessories required for effective life safety systems operation shall be permitted to be connected to the life safety branch.

#### (D) Communications Systems.

Hospital communications systems, where used for issuing instructions during emergency conditions. [99:6.7.5.1.2.4(3)]

#### (E) Generator Set Locations.

Generator set locations as follows:

- (1) Task illumination
- (2) Battery charger for emergency battery-powered lighting unit(s)
- (3) Select receptacles at the generator set location and essential electrical system transfer switch locations

[99:6.7.5.1.2.4(4)]

#### (F) Generator Set Accessories.

Loads dedicated to a specific generator, including the fuel transfer pump(s), ventilation fans, electrically operated louvers, controls, cooling system, and other generator accessories essential for generator operation, shall be connected to the life safety branch or to the output terminals of the generator with overcurrent protective devices. [99:6.7.5.1.2.6]

**(G)** Elevators.

Elevator cab lighting, control, communications, and signal systems. [99:6.7.5.1.2.4(5)]

**(H)** Automatic Doors.

Electrically powered doors used for building egress. [99:6.7.5.1.2.4(6)]

### Statement of Problem and Substantiation for Public Input

Again life safety branches should have a mandatory colors in the NEC .

Fire alarm has requirement of red junction box covers ,

The NEC should have color coding for life safety, critical ,equipment branches and 708 in the NEC

### Submitter Information Verification

**Submitter Full Name:** John Plourde

**Organization:** Portsmouth Nh City Of

**Affiliation:** Performance Electrical Training LLC.

**Street Address:**

**City:**

**State:**

**Zip:**

**Submittal Date:** Mon Jun 12 13:50:25 EDT 2023

**Committee:** NEC-P15



## Public Input No. 2980-NFPA 70-2023 [ Section No. 517.33(C) ]

### (C) Alarm and Alerting Systems.

Alarm and alerting systems including the following:

- (1) Fire alarm systems
- (2) Alarm and alerting systems (other than fire alarm systems) shall be connected to the life safety branch or critical branch. [99:6.7.5.1.2.5 3 ]
- (3) Alarms for systems used for the piping of nonflammable medical gases
- (4) Mechanical, control, and other accessories required for effective life safety systems operation shall be permitted to be connected to the life safety branch.

### Statement of Problem and Substantiation for Public Input

This public input is submitted on behalf of the Microgrid Task Group formed under the direction of the ELS Committee of NFPA 99 to provide correlation input to CMP-15 related to the use of microgrids and distributed energy resources in health care. The TG is also providing public inputs for consideration on any extracted language from 99 that has been modified in the 2024 edition of NFPA 99.

Extraction reference needs to be updated to the correct location in 2024 NFPA 99.

### Related Public Inputs for This Document

<u>Related Input</u>	<u>Relationship</u>
Public Input No. 2979-NFPA 70-2023 [Section No. 517.33 [Excluding any Sub-Sections]]	

### Submitter Information Verification

**Submitter Full Name:** Chris Finen  
**Organization:** Eaton Corporation  
**Street Address:**  
**City:**  
**State:**  
**Zip:**  
**Submission Date:** Mon Aug 28 14:20:21 EDT 2023  
**Committee:** NEC-P15





## Public Input No. 2114-NFPA 70-2023 [ Section No. 517.33(D) ]

### (D) Communications Systems.

(1) Hospital communications systems, where used for issuing instructions during emergency conditions. [99:6.7.5.1.2.4(3)]

(2) Emergency Responder Radio Communication Systems (ERRCs)

### Statement of Problem and Substantiation for Public Input

There is a federal requirement for all buildings to have radio coverage for first responders and emergency service personnel. Frequently this requires Public safety distributed antenna systems (DAS) often referred to as an Emergency Responder Radio Coverage System (ERRCS) which is a wireless communications system that's used exclusively by first responders and emergency service personnel, to be installed in healthcare buildings. The circuiting for the ERRCS is not currently covered in the code. We recommend we add this as required to be fed by the life safety branch of the Essential electrical system, as this is a fire and life safety load. (Similar to P.I. 2115 for Nursing homes and Limited Care Facilities)

### Related Public Inputs for This Document

<u>Related Input</u>	<u>Relationship</u>
<a href="#">Public Input No. 2115-NFPA 70-2023 [Section No. 517.43(D)]</a>	
<a href="#">Public Input No. 2115-NFPA 70-2023 [Section No. 517.43(D)]</a>	

### Submitter Information Verification

**Submitter Full Name:** Jamie Schnick

**Organization:** OSHPD/HCAI

**Affiliation:** Office of Hospitals Planning and Development/Department of Healthcare Access and Information – California

**Street Address:**

**City:**

**State:**

**Zip:**

**Submittal Date:** Sat Aug 12 09:17:31 EDT 2023

**Committee:** NEC-P15



## Public Input No. 2981-NFPA 70-2023 [ Section No. 517.33(D) ]

(D) Communications Systems.

~~Hospital communications~~ Communications systems, where used for issuing instructions during emergency conditions. [99:6.7.5.1.2.4 2 (3)]

### Statement of Problem and Substantiation for Public Input

This public input is submitted on behalf of the Microgrid Task Group formed under the direction of the ELS Committee of NFPA 99 to provide correlation input to CMP-15 related to the use of microgrids and distributed energy resources in health care. The TG is also providing public inputs for consideration on any extracted language from 99 that has been modified in the 2024 edition of NFPA 99.

Extraction reference needs to be updated to the correct location in 2024 NFPA 99. Term "hospital" is removed because it is not in the extracted language. Additionally, this requirement should have application to any health care occupancy type with Type 1 EES, not just hospitals.

### Related Public Inputs for This Document

<u>Related Input</u>	<u>Relationship</u>
<u>Public Input No. 2979-NFPA 70-2023 [Section No. 517.33 [Excluding any Sub-Sections]]</u>	

### Submitter Information Verification

**Submitter Full Name:** Chris Finen  
**Organization:** Eaton Corporation  
**Street Address:**  
**City:**  
**State:**  
**Zip:**  
**Submission Date:** Mon Aug 28 14:21:32 EDT 2023  
**Committee:** NEC-P15



## Public Input No. 2300-NFPA 70-2023 [ Section No. 517.33(E) ]

### (E) Generator Set Locations.

Generator set locations as follows:

- (1) Task illumination
- (2) Battery charger for ~~emergency- battery-powered lighting unit(s)~~ equipped emergency luminaires
- (3) Select receptacles at the generator set location and essential electrical system transfer switch locations

[99:6.7.5.1.2.4(4)]

### Statement of Problem and Substantiation for Public Input

The NEC 100 definition of “battery-powered lighting units”, associated with Art. 517, describes the design and intended function of equipment well-known within the emergency lighting community as “unit equipment.” In the 2023 revision cycle, unit equipment was recognized as a type of battery-equipped emergency luminaire, and the (relocated to Article 100) definition was updated accordingly. To promote the consistent use of terminology throughout the NEC, the term “battery-powered lighting unit” should be replaced with the broader term “battery-equipped emergency luminaire” because the intended functionality – to automatically illuminate when the monitored normal power circuit is disrupted – can be accomplished by more than just unit equipment.

Anesthetizing locations (517.63) should not be precluded from using battery-equipped emergency luminaires that also function for normal lighting purposes; for example, ceiling or recessed-ceiling mounted luminaires with integral battery backup power. Unit equipment (and, as currently defined, an “emergency battery-powered lighting unit”) is a separate device mounted on the wall and only illuminates when normal power is lost. There is no reason for anesthetizing locations to be precluded from adopting the more space and cost-efficient emergency lighting solutions widely used in other locations.

The revision to 517.33(E)(2) brings the same allowance for a generator set location to utilize the broader range of battery-equipped emergency luminaires rather than be restricted to the use of only unit equipment.

See also related PIs 2301 (for 517.63(A)) and 2299 (Article 100).

### Related Public Inputs for This Document

<u>Related Input</u>	<u>Relationship</u>
<a href="#">Public Input No. 2299-NFPA 70-2023 [Definition: Battery-Powered Lighting Units.]</a>	
<a href="#">Public Input No. 2301-NFPA 70-2023 [Section No. 517.63(A)]</a>	
<a href="#">Public Input No. 2299-NFPA 70-2023 [Definition: Battery-Powered Lighting Units.]</a>	
<a href="#">Public Input No. 2301-NFPA 70-2023 [Section No. 517.63(A)]</a>	

### Submitter Information Verification

**Submitter Full Name:** Michael Shulman

<b>Organization:</b>	UL Solutions
<b>Street Address:</b>	
<b>City:</b>	
<b>State:</b>	
<b>Zip:</b>	
<b>Submittal Date:</b>	Tue Aug 15 17:59:45 EDT 2023
<b>Committee:</b>	NEC-P15



## Public Input No. 2983-NFPA 70-2023 [ Section No. 517.33(E) ]

### (E) Generator Set Locations.

Generator set locations as follows:

- (1) Task illumination
- (2) Battery charger for emergency battery-powered lighting unit(s)
- (3) Select receptacles at the generator set location and essential electrical system transfer switch locations

[99:6.7.5.1.2.4 2 (4)]

### Statement of Problem and Substantiation for Public Input

This public input is submitted on behalf of the Microgrid Task Group formed under the direction of the ELS Committee of NFPA 99 to provide correlation input to CMP-15 related to the use of microgrids and distributed energy resources in health care. The TG is also providing public inputs for consideration on any extracted language from 99 that has been modified in the 2024 edition of NFPA 99.

Extraction reference needs to be updated to the correct location in 2024 NFPA 99.

### Related Public Inputs for This Document

<u>Related Input</u>	<u>Relationship</u>
Public Input No. 2979-NFPA 70-2023 [Section No. 517.33 [Excluding any Sub-Sections]]	

### Submitter Information Verification

**Submitter Full Name:** Chris Finen  
**Organization:** Eaton Corporation  
**Street Address:**  
**City:**  
**State:**  
**Zip:**  
**Submittal Date:** Mon Aug 28 14:24:19 EDT 2023  
**Committee:** NEC-P15



## Public Input No. 3595-NFPA 70-2023 [ Section No. 517.33(E) ]

(E)– Generator Set Locations.

Generator set

On-site Source Equipment Locations.

On-site source equipment locations as follows:

- (1) Task illumination
- (2) Battery charger for emergency battery-powered lighting unit(s)
- (3) Select receptacles at the generator set location and essential electrical system transfer switch locations

[99:6.7.5.1.2.4(4)]

### Statement of Problem and Substantiation for Public Input

This requirement should apply to all sources.

### Submitter Information Verification

**Submitter Full Name:** Walter Vernon

**Organization:** Mazzetti

**Street Address:**

**City:**

**State:**

**Zip:**

**Submittal Date:** Tue Sep 05 05:30:00 EDT 2023

**Committee:** NEC-P15



## Public Input No. 2985-NFPA 70-2023 [ Section No. 517.33(F) ]

### (F) Generator Set Accessories.

Loads dedicated to a specific generator, including the fuel transfer pump(s), ventilation fans, electrically operated louvers, controls, cooling system, and other generator accessories essential for generator operation, shall be connected to the life safety branch or to the output terminals of the generator with overcurrent protective devices. [99:6.7.5.1.2.6 4 ]

### Statement of Problem and Substantiation for Public Input

This public input is submitted on behalf of the Microgrid Task Group formed under the direction of the ELS Committee of NFPA 99 to provide correlation input to CMP-15 related to the use of microgrids and distributed energy resources in health care. The TG is also providing public inputs for consideration on any extracted language from 99 that has been modified in the 2024 edition of NFPA 99.

Extraction reference needs to be updated to the correct location in 2024 NFPA 99.

### Related Public Inputs for This Document

<u>Related Input</u>	<u>Relationship</u>
<u>Public Input No. 2979-NFPA 70-2023 [Section No. 517.33 [Excluding any Sub-Sections]]</u>	

### Submitter Information Verification

**Submitter Full Name:** Chris Finen  
**Organization:** Eaton Corporation  
**Street Address:**  
**City:**  
**State:**  
**Zip:**  
**Submission Date:** Mon Aug 28 14:27:32 EDT 2023  
**Committee:** NEC-P15



## Public Input No. 3596-NFPA 70-2023 [ Section No. 517.33(F) ]

~~(F)– Generator Set Accessories~~ On-site Source Accessories .

Loads dedicated to ~~a specific generator, including the fuel-~~ an on-site source, including fuel transfer pump(s), ventilation fans, electrically operated louvers, controls, cooling system, and ~~other generator accessories-~~ other accessories essential for ~~generator-~~ effective operation, shall be connected to the life safety branch- ~~or to the output terminals of the generator with~~ overcurrent protective devices . [99:6.7.5.1.2.6]

### Statement of Problem and Substantiation for Public Input

The power source for the essential system can be many things, not simply a generator.

### Submitter Information Verification

**Submitter Full Name:** Walter Vernon

**Organization:** Mazzetti

**Street Address:**

**City:**

**State:**

**Zip:**

**Submittal Date:** Tue Sep 05 05:32:03 EDT 2023

**Committee:** NEC-P15





## Public Input No. 2986-NFPA 70-2023 [ Section No. 517.33(G) ]

(G) Elevators.

Elevator cab lighting, control, communications, and signal systems. [99:6.7.5.1.2.4 2 (5)]

### Statement of Problem and Substantiation for Public Input

This public input is submitted on behalf of the Microgrid Task Group formed under the direction of the ELS Committee of NFPA 99 to provide correlation input to CMP-15 related to the use of microgrids and distributed energy resources in health care. The TG is also providing public inputs for consideration on any extracted language from 99 that has been modified in the 2024 edition of NFPA 99.

Extraction reference needs to be updated to the correct location in 2024 NFPA 99.

### Related Public Inputs for This Document

<u>Related Input</u>	<u>Relationship</u>
Public Input No. 2979-NFPA 70-2023 [Section No. 517.33 [Excluding any Sub-Sections]]	

### Submitter Information Verification

**Submitter Full Name:** Chris Finen  
**Organization:** Eaton Corporation  
**Street Address:**  
**City:**  
**State:**  
**Zip:**  
**Submittal Date:** Mon Aug 28 14:28:30 EDT 2023  
**Committee:** NEC-P15



## Public Input No. 2987-NFPA 70-2023 [ Section No. 517.33(H) ]

(H) Automatic Doors.

Electrically powered doors used for building egress. [99:6.7.5.1.2.4 2 (6)]

### Statement of Problem and Substantiation for Public Input

This public input is submitted on behalf of the Microgrid Task Group formed under the direction of the ELS Committee of NFPA 99 to provide correlation input to CMP-15 related to the use of microgrids and distributed energy resources in health care. The TG is also providing public inputs for consideration on any extracted language from 99 that has been modified in the 2024 edition of NFPA 99.

Extraction reference needs to be updated to the correct location in 2024 NFPA 99.

### Related Public Inputs for This Document

<u>Related Input</u>	<u>Relationship</u>
Public Input No. 2979-NFPA 70-2023 [Section No. 517.33 [Excluding any Sub-Sections]]	

### Submitter Information Verification

**Submitter Full Name:** Chris Finen  
**Organization:** Eaton Corporation  
**Street Address:**  
**City:**  
**State:**  
**Zip:**  
**Submittal Date:** Mon Aug 28 14:30:02 EDT 2023  
**Committee:** NEC-P15



## Public Input No. 2979-NFPA 70-2023 [ Section No. 517.33 [Excluding any Sub-Sections] ]

The life safety branch shall be limited to circuits essential to life safety. [99:6.7.5.1.2.3 1 ]

No functions other than those listed in 517.33(A) through (H) shall be connected to the life safety branch. The life safety branch shall supply power as follows:

### Statement of Problem and Substantiation for Public Input

This public input is submitted on behalf of the Microgrid Task Group formed under the direction of the ELS Committee of NFPA 99 to provide correlation input to CMP-15 related to the use of microgrids and distributed energy resources in health care. The TG is also providing public inputs for consideration on any extracted language from 99 that has been modified in the 2024 edition of NFPA 99.

Extraction reference needs to be updated to the correct location in 2024 NFPA 99.

### Related Public Inputs for This Document

<u>Related Input</u>	<u>Relationship</u>
<a href="#">Public Input No. 2980-NFPA 70-2023 [Section No. 517.33(C)]</a>	Same extraction reference update issue
<a href="#">Public Input No. 2981-NFPA 70-2023 [Section No. 517.33(D)]</a>	Same extraction reference update issue
<a href="#">Public Input No. 2983-NFPA 70-2023 [Section No. 517.33(E)]</a>	Same extraction reference update issue
<a href="#">Public Input No. 2985-NFPA 70-2023 [Section No. 517.33(F)]</a>	Same extraction reference update issue
<a href="#">Public Input No. 2986-NFPA 70-2023 [Section No. 517.33(G)]</a>	Same extraction reference update issue
<a href="#">Public Input No. 2987-NFPA 70-2023 [Section No. 517.33(H)]</a>	Same extraction reference update issue

### Submitter Information Verification

**Submitter Full Name:** Chris Finen  
**Organization:** Eaton Corporation  
**Street Address:**  
**City:**  
**State:**  
**Zip:**  
**Submittal Date:** Mon Aug 28 14:18:28 EDT 2023  
**Committee:** NEC-P15



**Public Input No. 2145-NFPA 70-2023 [ Section No. 517.34(A) ]**

A large, empty rectangular box with a thin border, intended for public input or comments.

**(A) Task Illumination, Fixed Equipment, and Select Receptacles.**—~~The critical branch shall supply power for~~

~~task illumination, fixed equipment, select receptacles, and select power circuits serving~~

~~:~~

- 
- (1) Task illumination and select receptacles in the following spaces and functions related to patient care: Task illumination and select receptacles in the following:
  - (2) Category 1 spaces where deep sedation or general anesthesia is administered, task illumination, select receptacles, and fixed equipment
  - (3)
    - a. Patient care spaces, including infant nurseries, selected acute nursing areas, psychiatric bed areas (omit receptacles), and ward treatment rooms
    - b. Medication preparation spaces
    - c. Pharmacy dispensing spaces
    - d. Nurses' stations — unless adequately lighted by corridor luminaires
  - (4) Additional specialized patient care task illumination and receptacles, where needed
  - (5) Nurse call systems
  - (6) Blood, bone, and tissue banks
  - (7) Telecommunications entrance facility, telecommunications equipment rooms, and telecommunication rooms and equipment in these rooms
  - (8)
    - a. stations
  - (9) Task illumination, select receptacles, and select power circuits for the following areas:
    - (10) Category 1 spaces where deep sedation or general anesthesia is administered.
    - (11) Category 1 or 2 spaces with at least one duplex receptacle per patient bed location, and task illumination as required by the governing body of the health care facility
    - (12) Angiographic labs
    - (13) Cardiac catheterization labs
    - (14) Coronary care units
    - (15) Hemodialysis rooms or areas
    - (16) Emergency room treatment areas (select)
    - (17) Human physiology labs
    - (18) Intensive care units
    - (19) Postoperative recovery rooms (select)
  - (20) Nurse call systems
  - (21) Blood, bone, and tissue banks
  - (22) Telecommunications entrance facility, telecommunications equipment rooms, and telecommunication rooms and equipment in these rooms
  - (23) Clinical IT-network equipment
  - (24) Wireless phone and paging equipment for clinical staff communications
  - (25) Additional task illumination, receptacles, and select power circuits needed for effective facility operation, including single-phase fractional horsepower motors, which are

permitted to be connected to the critical branch

[99:6.7.5.1.3.2]

## Statement of Problem and Substantiation for Public Input

The presentation of requirements in this section is confusing.

The proposed rearrangement of requirements is intended to simplify by removing redundant/confusing language and developing a hierarchy of requirements:

- Spaces where task illumination and select receptacles are required to be connected to the critical branch
- Spaces where task illumination, select receptacles and select power circuits are required to be connected to the critical branch
- Specific equipment required to be connected to the critical branch

## Submitter Information Verification

**Submitter Full Name:** Jamie Schnick  
**Organization:** OSHPD/HCAI  
**Affiliation:** Office of Hospitals Planning and Development/Department of Healthcare Access and Information – California  
**Street Address:**  
**City:**  
**State:**  
**Zip:**  
**Submittal Date:** Sun Aug 13 11:09:33 EDT 2023  
**Committee:** NEC-P15



## Public Input No. 2146-NFPA 70-2023 [ Section No. 517.35 ]

### **517.35** Equipment Branch Connection to Alternate Power Source.

The equipment branch shall be installed and connected to the alternate power source such that the equipment described in 517.35(A) is automatically restored to operation at appropriate time-lag intervals following the energizing of the life safety and critical branches.

[99:6.7.5.1.4.2(A)]

The arrangement of the connection to the alternate power source shall also provide for the subsequent connection of equipment described in 517.35(B). [99:6.7.5.1.4.2(B)]

*Exception: For essential electrical systems under 150 kVA, deletion of the time-lag intervals feature for delayed automatic connection to the equipment system shall be permitted.*

#### **(A)** Equipment for Delayed Automatic Connection.

The following equipment shall be connected to the equipment branch and is permitted to be arranged for delayed automatic connection to the alternate power source:

- (1) Central suction systems serving medical and surgical functions, including controls, with such suction systems permitted to be placed on the critical branch
- (2) Sump pumps and other equipment required to operate for the safety of major apparatus, including associated control systems and alarms
- (3) Compressed air systems serving medical and surgical functions, including controls with such air systems permitted to be placed on the critical branch
- (4) Smoke control and stair pressurization systems
- (5) Kitchen hood supply or exhaust systems, or both, if required to operate during a fire in or under the hood
- (6) Supply, return, and exhaust ventilating systems for the following:
  - (7) Airborne infectious/isolation rooms
  - (8) Protective environment rooms
  - (9) Exhaust fans for laboratory fume hoods
  - (10) Nuclear medicine areas where radioactive material is used
  - (11) Ethylene oxide evacuation
  - (12) Anesthetic evacuation

[99:6.7.5.1.4.3(A)]

Where delayed automatic connection is not appropriate, the ventilation systems specified in 517.35(A)(6) shall be permitted to be placed on the critical branch. [99:6.7.5.1.4.3(B)]

- (13) Supply, return, and exhaust ventilating systems for operating and delivery rooms
- (14) Supply, return, exhaust ventilating systems and/or air-conditioning systems serving telephone equipment rooms and closets and data equipment rooms and closets

*Exception: Sequential delayed automatic connection to the alternate power source to prevent overloading the generator shall be permitted where engineering studies indicate it is necessary.*



**(B) Equipment for Delayed Automatic or Manual Connection.**

The following equipment shall be connected to the equipment branch and is permitted to be arranged for either delayed automatic or manual connection to the alternate power source:

- (1) Heating equipment to provide heating for operating, delivery, labor, recovery, intensive care, coronary care, nurseries, infection/isolation rooms, emergency treatment spaces, and general patient rooms and pressure maintenance (jockey or make-up) pump(s) for water-based fire protection systems

*Exception: Heating of general patient rooms and infection/isolation rooms during disruption of the normal source shall not be required under any of the following conditions:*

- (1) *The outside design temperature is higher than  $-6.7^{\circ}\text{C}$  ( $20^{\circ}\text{F}$ ).*
- (2) *The outside design temperature is lower than  $-6.7^{\circ}\text{C}$  ( $20^{\circ}\text{F}$ ), and where a selected room(s) is provided for the needs of all confined patients, only such room(s) need be heated.*
- (3) *The facility is served by a dual source of normal power.*

Informational Note No. 1: The design temperature is based on the 97.5 percent design value as shown in Chapter 24 of the ASHRAE *Handbook of Fundamentals* (2013).

Informational Note No. 2: See 517.30(C) for a description of a dual source of normal power.

- (2) An elevator(s) selected to provide service to patient, surgical, obstetrical, and ground floors during interruption of normal power. In instances where interruption of normal power would result in other elevators stopping between floors, throw-over facilities shall be provided to allow the temporary operation of any elevator for the release of patients or other persons who may be confined between floors.
  - (3) Hyperbaric facilities.
  - (4) Hypobaric facilities.
  - (5) Automatically operated doors.
  - (6) Minimal electrically heated autoclaving equipment shall be permitted to be arranged for either automatic or manual connection to the alternate source.
  - (7) Controls for equipment listed in 517.35.
  - (8) Other selected equipment shall be permitted to be served by the equipment system.
- [99:6.7.5.1.4.4]

**Statement of Problem and Substantiation for Public Input**

The language for (A) and (B) is confusing. It is clear that the charging statement found in 517.35 is that the equipment described in 517.35(A) and 517.35(B) is required to be connected to the equipment branch, however the statements in section A and B "shall be permitted to be arranged for ..." is sometimes misinterpreted as to not required to be connected to the equipment branch.

We feel that the proposed revision will eliminate this confusion.

(Note only change is section A, additional underlining of (6 a-f) looks to be a formatting issue)

**Submitter Information Verification**

**Submitter Full Name:** Jamie Schnick

**Organization:** OSHPD/HCAI

**Affiliation:** Office of Hospitals Planning and Development/Department of  
Healthcare Access and Information – California

**Street Address:**

**City:**

**State:**

**Zip:**

**Submittal Date:** Sun Aug 13 11:49:52 EDT 2023

**Committee:** NEC-P15



## Public Input No. 2221-NFPA 70-2023 [ Section No. 517.35 ]

### **517.35** Equipment Branch Connection to Alternate Power Source.

The equipment branch shall be installed and connected to the alternate power source such that the equipment described in 517.35(A) is automatically restored to operation at appropriate time-lag intervals following the energizing of the life safety and critical branches. [99:6.7.5.1.4.2(A)]

The arrangement of the connection to the alternate power source shall also provide for the subsequent connection of equipment described in 517.35(B). [99:6.7.5.1.4.2(B)]

*Exception: For essential electrical systems under 150 kVA, deletion of the time-lag intervals feature for delayed automatic connection to the equipment system shall be permitted.*

#### **(A)** Equipment for Delayed Automatic Connection.

The following equipment shall be permitted to be arranged for delayed automatic connection to the alternate power source:

- (1) Central suction systems serving medical and surgical functions, including controls, with such suction systems permitted to be placed on the critical branch
- (2) Sump pumps and other equipment required to operate for the safety of major apparatus, including associated control systems and alarms
- (3) Compressed air systems serving medical and surgical functions, including controls with such air systems permitted to be placed on the critical branch
- (4) Smoke control and stair pressurization systems
- (5) Kitchen hood supply or exhaust systems, or both, if required to operate during a fire in or under the hood
- (6) Supply, return, and exhaust ventilating systems for the following:
  - (7) Airborne infectious/isolation rooms
  - (8) Protective environment rooms
  - (9) Exhaust fans for laboratory fume hoods
  - (10) Nuclear medicine areas where radioactive material is used
  - (11) Ethylene oxide evacuation
  - (12) Anesthetic evacuation

#### **[99:6.7.5.1.4.3(A)]**

Where delayed automatic connection is not appropriate, the ventilation systems specified in 517.35(A)(6) shall be permitted to be placed on the critical branch. [99:6.7.5.1.4.3(B)]

- (13) Supply, return, and exhaust ventilating systems for operating and delivery rooms
- (14) Supply, return, exhaust ventilating systems and/or air-conditioning systems serving telephone equipment rooms and closets and data equipment rooms and closets

*Exception: Sequential delayed automatic connection to the alternate power source to prevent overloading the generator shall be permitted where engineering studies indicate it is necessary.*

**(B) Equipment for Delayed Automatic or Manual Connection.**

The following equipment shall be permitted to be arranged for either delayed automatic or manual connection to the alternate power source:

- (1) Heating equipment to provide heating for operating, delivery, labor, recovery, intensive care, coronary care, nurseries, infection/isolation rooms, emergency treatment spaces, and general patient rooms and pressure maintenance (jockey or make-up) pump(s) for water-based fire protection systems

*Exception: Heating of general patient rooms and infection/isolation rooms during disruption of the normal source shall not be required under any of the following conditions:*

- (1) *The outside design temperature is higher than  $-6.7^{\circ}\text{C}$  ( $20^{\circ}\text{F}$ ).*
- (2) *The outside design temperature is lower than  $-6.7^{\circ}\text{C}$  ( $20^{\circ}\text{F}$ ), and where a selected room(s) is provided for the needs of all confined patients, only such room(s) need be heated.*
- (3) *The facility is served by a dual source of normal power.*

Informational Note No. 1: The design temperature is based on the 97.5 percent design value as shown in Chapter 24 of the ASHRAE *Handbook of Fundamentals* (2013).

Informational Note No. 2: See 517.30(C) for a description of a dual source of normal power.

- (2) An elevator(s) selected to provide service to patient, surgical, obstetrical, and ground floors during interruption of normal power. In instances where interruption of normal power would result in other elevators stopping between floors, throw-over facilities shall be provided to allow the temporary operation of any elevator for the release of patients or other persons who may be confined between floors.
  - (3) Hyperbaric facilities.
  - (4) Hypobaric facilities.
  - (5) Automatically operated doors.
  - (6) ~~Minimal electrically heated autoclaving equipment shall be permitted to be arranged for either automatic or manual connection to the alternate source. Small, Benchtop and Compact Top loading type autoclaves with single phase power feeds~~
  - (7) Controls for equipment listed in 517.35.
  - (8) Other selected equipment shall be permitted to be served by the equipment system.
- [99:6.7.5.1.4.4]

## Statement of Problem and Substantiation for Public Input

The language for the requirements for Autoclave circuiting is confusing. It is clear that the charging statement found in 517.35 is that the equipment described in 517.35(B) is required to be connected to the equipment branch, however the redundant statement in 517.35(B)(6) "shall be permitted to be arranged for...) is sometimes misinterpreted as to not required to be connected to the equipment branch.

We feel that the proposed revision to eliminate "shall be permitted to be ....." here will eliminate this confusion.

Additionally, the term "Minimal electrically heated autoclaving equipment" is confusing. It is not clear if the intent is for a small number of electrically heated autoclaving equipment, or all small (in size) electrically heated autoclaving equipment (Which would be located local to the area of use) are required to be connected to the critical branch.

The proposed revision that clarifies by stating small (Note for this section we have submitted 3 P.I's,

2147, 2148 and 2221. All are variations on the same input and only one should be accepted)

## Related Public Inputs for This Document

<u>Related Input</u>	<u>Relationship</u>
<a href="#">Public Input No. 2147-NFPA 70-2023 [Section No. 517.35(B)]</a>	
<a href="#">Public Input No. 2148-NFPA 70-2023 [Section No. 517.35(B)]</a>	
<a href="#">Public Input No. 2147-NFPA 70-2023 [Section No. 517.35(B)]</a>	
<a href="#">Public Input No. 2148-NFPA 70-2023 [Section No. 517.35(B)]</a>	

## Submitter Information Verification

**Submitter Full Name:** Jamie Schnick

**Organization:** OSHPD/HCAI

**Affiliation:** Office of Hospitals Planning and Development/Department of Healthcare Access and Information – California

**Street Address:**

**City:**

**State:**

**Zip:**

**Submittal Date:** Tue Aug 15 11:29:51 EDT 2023

**Committee:** NEC-P15



## Public Input No. 2989-NFPA 70-2023 [ Section No. 517.35 ]

### **517.35** Equipment Branch Connection to ~~Alternate~~ On-Site Power Source.

The equipment branch shall be installed and connected to the ~~alternate~~ on-site power source such that the equipment described in 517.35(A) is automatically restored to operation at appropriate time-lag intervals following the energizing of the life safety and critical branches. [99:6.7.5.1.4.2(A)]

The arrangement of the connection to the ~~alternate~~ on-site power source shall also provide for the subsequent connection of equipment described in 517.35(B). [99:6.7.5.1.4.2(B)]

*Exception: For essential electrical systems under 150 kVA, deletion of the time-lag intervals feature for delayed automatic connection to the equipment system shall be permitted.*

#### **(A)** Equipment for Delayed Automatic Connection.

The following equipment shall be permitted to be arranged for delayed automatic connection to the ~~alternate~~ on-site power source:

- (1) Central suction systems serving medical and surgical functions, including controls, with such suction systems permitted to be placed on the critical branch
- (2) Sump pumps and other equipment required to operate for the safety of major apparatus, including associated control systems and alarms
- (3) Compressed air systems serving medical and surgical functions, including controls with such air systems permitted to be placed on the critical branch
- (4) Smoke control and stair pressurization systems
- (5) Kitchen hood supply or exhaust systems, or both, if required to operate during a fire in or under the hood
- (6) Supply, return, and exhaust ventilating systems for the following:
  - (7) Airborne infectious/isolation rooms
  - (8) Protective environment rooms
  - (9) Exhaust fans for laboratory fume hoods
  - (10) Nuclear medicine areas where radioactive material is used
  - (11) Ethylene oxide evacuation
  - (12) Anesthetic evacuation

#### **[99:6.7.5.1.4.3(A)]**

Where delayed automatic connection is not appropriate, the ventilation systems specified in 517.35(A)(6) shall be permitted to be placed on the critical branch. [99:6.7.5.1.4.3(B)]

- (13) Supply, return, and exhaust ventilating systems for operating and delivery rooms
- (14) Supply, return, exhaust ventilating systems and/or air-conditioning systems serving telephone equipment rooms and closets and data equipment rooms and closets

*Exception: Sequential delayed automatic connection to the alternate power source to prevent overloading the generator shall be permitted where engineering studies indicate it is necessary.*

**(B) Equipment for Delayed Automatic or Manual Connection.**

The following equipment shall be permitted to be arranged for either delayed automatic or manual connection to the ~~alternate~~ on-site power source:

- (1) Heating equipment to provide heating for operating, delivery, labor, recovery, intensive care, coronary care, nurseries, infection/isolation rooms, emergency treatment spaces, and general patient rooms and pressure maintenance (jockey or make-up) pump(s) for water-based fire protection systems

*Exception: Heating of general patient rooms and infection/isolation rooms during disruption of the normal source shall not be required under any of the following conditions:*

- (1) *The outside design temperature is higher than  $-6.7^{\circ}\text{C}$  ( $20^{\circ}\text{F}$ ).*
- (2) *The outside design temperature is lower than  $-6.7^{\circ}\text{C}$  ( $20^{\circ}\text{F}$ ), and where a selected room(s) is provided for the needs of all confined patients, only such room(s) need be heated.*
- (3) *The facility is served by a dual source of normal power.*

Informational Note No. 1: The design temperature is based on the 97.5 percent design value as shown in Chapter 24 of the ASHRAE *Handbook of Fundamentals* (2013).

Informational Note No. 2: See 517.30(C) for a description of a dual source of normal power.

- (2) An elevator(s) selected to provide service to patient, surgical, obstetrical, and ground floors during interruption of normal power. In instances where interruption of normal power would result in other elevators stopping between floors, throw-over facilities shall be provided to allow the temporary operation of any elevator for the release of patients or other persons who may be confined between floors.
- (3) Hyperbaric facilities.
- (4) Hypobaric facilities.
- (5) Automatically operated doors.
- (6) Minimal electrically heated autoclaving equipment shall be permitted to be arranged for either automatic or manual connection to the alternate source.
- (7) Controls for equipment listed in 517.35.
- (8) Other selected equipment shall be permitted to be served by the equipment system.  
[99:6.7.5.1.4.4(9)]

## Statement of Problem and Substantiation for Public Input

This public input is submitted on behalf of the Microgrid Task Group formed under the direction of the ELS Committee of NFPA 99 to provide correlation input to CMP-15 related to the use of microgrids and distributed energy resources in health care. The TG is also providing public inputs for consideration on any extracted language from 99 that has been modified in the 2024 edition of NFPA 99.

Replace "alternate" with "on-site" to match extraction language. Extraction reference in 517.35(B)(8) was missing the (9) parenthetical.

## Submitter Information Verification

**Submitter Full Name:** Chris Finen

**Organization:** Eaton Corporation

**Street Address:**

**City:**

**State:**

**Zip:**

**Submittal Date:** Mon Aug 28 14:36:20 EDT 2023

**Committee:** NEC-P15





## Public Input No. 2147-NFPA 70-2023 [ Section No. 517.35(B) ]

### (B) Equipment for Delayed Automatic or Manual Connection.

The following equipment shall be permitted to be arranged for either delayed automatic or manual connection to the alternate power source:

- (1) Heating equipment to provide heating for operating, delivery, labor, recovery, intensive care, coronary care, nurseries, infection/isolation rooms, emergency treatment spaces, and general patient rooms and pressure maintenance (jockey or make-up) pump(s) for water-based fire protection systems

*Exception: Heating of general patient rooms and infection/isolation rooms during disruption of the normal source shall not be required under any of the following conditions:*

- (1) *The outside design temperature is higher than  $-6.7^{\circ}\text{C}$  ( $20^{\circ}\text{F}$ ).*
- (2) *The outside design temperature is lower than  $-6.7^{\circ}\text{C}$  ( $20^{\circ}\text{F}$ ), and where a selected room(s) is provided for the needs of all confined patients, only such room(s) need be heated.*
- (3) *The facility is served by a dual source of normal power.*

Informational Note No. 1: The design temperature is based on the 97.5 percent design value as shown in Chapter 24 of the ASHRAE *Handbook of Fundamentals* (2013).

Informational Note No. 2: See 517.30(C) for a description of a dual source of normal power.

- (2) An elevator(s) selected to provide service to patient, surgical, obstetrical, and ground floors during interruption of normal power. In instances where interruption of normal power would result in other elevators stopping between floors, throw-over facilities shall be provided to allow the temporary operation of any elevator for the release of patients or other persons who may be confined between floors.
- (3) Hyperbaric facilities.
- (4) Hypobaric facilities.
- (5) Automatically operated doors.
- (6) Minimal electrically heated autoclaving equipment. ~~shall be permitted to be arranged for either automatic or manual connection to the alternate source .~~
- (7) Controls for equipment listed in 517.35.
- (8) Other selected equipment shall be permitted to be served by the equipment system.  
[99:6.7.5.1.4.4]

### Statement of Problem and Substantiation for Public Input

The language for the requirements for Autoclave circuiting is confusing. It is clear that the charging statement found in 517.35 is that the equipment described in 517.35(B) is required to be connected to the equipment branch, however the redundant statement in 517.35(B)(6) "shall be permitted to be arranged for...) is sometimes misinterpreted as to not required to be connected to the equipment branch.

We feel that the proposed revision to eliminate "shall be permitted to be ....." here will eliminate this confusion.

(Note for this section we have submitted 3 P.I's, 2147, 2187 and 2221. All are variations on the same input and only one should be accepted)

## Related Public Inputs for This Document

<u>Related Input</u>	<u>Relationship</u>
<a href="#">Public Input No. 2221-NFPA 70-2023 [Section No. 517.35]</a>	
<a href="#">Public Input No. 2148-NFPA 70-2023 [Section No. 517.35(B)]</a>	
<a href="#">Public Input No. 2148-NFPA 70-2023 [Section No. 517.35(B)]</a>	
<a href="#">Public Input No. 2221-NFPA 70-2023 [Section No. 517.35]</a>	

## Submitter Information Verification

**Submitter Full Name:** Jamie Schnick  
**Organization:** OSHPD/HCAI  
**Affiliation:** Office of Hospitals Planning and Development/Department of Healthcare Access and Information – California  
**Street Address:**  
**City:**  
**State:**  
**Zip:**  
**Submittal Date:** Sun Aug 13 11:57:28 EDT 2023  
**Committee:** NEC-P15



## Public Input No. 2148-NFPA 70-2023 [ Section No. 517.35(B) ]

### (B) Equipment for Delayed Automatic or Manual Connection.

The following equipment shall be permitted to be arranged for either delayed automatic or manual connection to the alternate power source:

- (1) Heating equipment to provide heating for operating, delivery, labor, recovery, intensive care, coronary care, nurseries, infection/isolation rooms, emergency treatment spaces, and general patient rooms and pressure maintenance (jockey or make-up) pump(s) for water-based fire protection systems

*Exception: Heating of general patient rooms and infection/isolation rooms during disruption of the normal source shall not be required under any of the following conditions:*

- (1) *The outside design temperature is higher than  $-6.7^{\circ}\text{C}$  ( $20^{\circ}\text{F}$ ).*
- (2) *The outside design temperature is lower than  $-6.7^{\circ}\text{C}$  ( $20^{\circ}\text{F}$ ), and where a selected room(s) is provided for the needs of all confined patients, only such room(s) need be heated.*
- (3) *The facility is served by a dual source of normal power.*

Informational Note No. 1: The design temperature is based on the 97.5 percent design value as shown in Chapter 24 of the ASHRAE *Handbook of Fundamentals* (2013).

Informational Note No. 2: See 517.30(C) for a description of a dual source of normal power.

- (2) An elevator(s) selected to provide service to patient, surgical, obstetrical, and ground floors during interruption of normal power. In instances where interruption of normal power would result in other elevators stopping between floors, throw-over facilities shall be provided to allow the temporary operation of any elevator for the release of patients or other persons who may be confined between floors.
- (3) Hyperbaric facilities.
- (4) Hypobaric facilities.
- (5) Automatically operated doors.
- (6) ~~Minimal electrically heated autoclaving equipment shall be permitted to be arranged for either automatic or manual connection to the alternate source~~ autoclaving equipment - at least one per building .
- (7) Controls for equipment listed in 517.35.
- (8) Other selected equipment shall be permitted to be served by the equipment system.

[99:6.7.5.1.4.4]

### Statement of Problem and Substantiation for Public Input

The language for the requirements for Autoclave circuiting is confusing. It is clear that the charging statement found in 517.35 is that the equipment described in 517.35(B) is required to be connected to the equipment branch, however the redundant statement in 517.35(B)(6) "shall be permitted to be arranged for...) is sometimes misinterpreted as to not required to be connected to the equipment branch.

We feel that the proposed revision to eliminate "shall be permitted to be ....." here will eliminate this

confusion.

Additionally, the term "Minimal electrically heated autoclaving equipment" is confusing. It is not clear if the intent is for a small number of electrically heated autoclaving equipment, or all small (in size) electrically heated autoclaving equipment (Which would be located local to the area of use) are required to be connected to the critical branch.

The proposed revision that adds "at least one" clarifies that the term minimal is in regard to the number of electric autoclaves required to be connected to the critical branch to help clarify the intent of this code section. (Note for this section we have submitted 3 P.I's, 2147, 2148 and 2221. All are variations on the same input and only one should be accepted)

## Related Public Inputs for This Document

<u>Related Input</u>	<u>Relationship</u>
<a href="#">Public Input No. 2221-NFPA 70-2023 [Section No. 517.35]</a>	
<a href="#">Public Input No. 2147-NFPA 70-2023 [Section No. 517.35(B)]</a>	
<a href="#">Public Input No. 2147-NFPA 70-2023 [Section No. 517.35(B)]</a>	
<a href="#">Public Input No. 2221-NFPA 70-2023 [Section No. 517.35]</a>	

## Submitter Information Verification

**Submitter Full Name:** Jamie Schnick

**Organization:** OSHPD/HCAI

**Affiliation:** Office of Hospitals Planning and Development/Department of Healthcare Access and Information – California

**Street Address:**

**City:**

**State:**

**Zip:**

**Submittal Date:** Sun Aug 13 12:03:37 EDT 2023

**Committee:** NEC-P15



## Public Input No. 2149-NFPA 70-2023 [ Section No. 517.40 ]

### 517.40 Type 2 Essential Electrical Systems.

Informational Note No. 1: Nursing homes and other limited care facilities can contain Category 1 and/or Category 2 patient care spaces, depending on the design and type of care administered in the facility. For Category 1 spaces, see 517.29 through 517.35. For Category 2 spaces not served by Type 1 essential electrical systems, see 517.40 through 517.44.

Informational Note No. 2: Type 2 essential electrical systems are comprised of two separate branches capable of supplying a limited amount of lighting and power service that is considered essential for the protection of life and safety and effective operation of the institution during the time normal electrical service is interrupted for any reason. These two separate branches are the life safety and equipment branches. The number of transfer switches to be used should be based upon reliability, design, and load considerations. Each branch of the essential electrical system should have one or more transfer switches. One transfer switch should be permitted to serve one or more branches in a facility with a maximum demand on the essential electrical system of 150 kVA (120 kW). [99:A.6.7.6.2.1]

#### (A) Applicability.

The requirements of 517.40(C) through 517.44 shall apply to Type 2 essential electrical systems (EES) Category 2 spaces shall be served by a type 1 or type 2 EES [99:6 .5.1].

*Exception: The requirements of 517.40(C) through 517.44 shall not apply to freestanding buildings used as nursing homes and limited care facilities if the following apply:*

- *Admitting and discharge policies are maintained that preclude the provision of care for any patient or resident who might need to be sustained by electrical life-support equipment.*
- *No surgical treatment requiring general anesthesia is offered.*  
*An automatic battery-operated system*

(

s) or equipment shall be effective for at least

1

1/2 hours and is otherwise in accordance with 700.12 and that shall be capable of supplying lighting for exit lights, exit corridors, stairways, nursing stations, medical preparation areas, boiler rooms, and communications areas. This system shall also supply power to operate all alarm systems.

Informational Note: See NFPA 101 -2021, *Life Safety Code* .

#### (B) Category 1 Spaces in Inpatient Hospital Care Facilities.

*For those nursing homes and limited care facilities that admit patients who need to be sustained by electrical life-support equipment, the essential electrical system from the source to the portion of the facility where such patients are treated shall comply with the requirements of 517.29 through 517.35 .*

(C 2)\_ Facilities Contiguous or Located on the Same Site with Hospitals.

Nursing homes and limited care facilities that are contiguous or located on the same site with a hospital shall be permitted to have their essential electrical systems supplied by the hospital.

Informational Note: Category 3 or Category 4 spaces shall not be required to be served by an EES [ 99: 6..1].

## Statement of Problem and Substantiation for Public Input

The code as written appears to be stating that 517.40(C) through 517.44 shall apply to Category 2 spaces that do not include nursing homes and limited care facilities (non-subacute) and category 1 spaces in nursing homes and limited care facilities (subacute).

Based on my understanding of the code this is not the intent. The proposed revisions we feel will bring the language of the code in line with the intent. (517.40(C) through 517.44 shall apply to Category 2 non-subacute facilities.

## Submitter Information Verification

**Submitter Full Name:** Jamie Schnick  
**Organization:** OSHPD/HCAI  
**Affiliation:** Office of Hospitals Planning and Development/Department of Healthcare Access and Information – California  
**Street Address:**  
**City:**  
**State:**  
**Zip:**  
**Submittal Date:** Sun Aug 13 12:15:32 EDT 2023  
**Committee:** NEC-P15



## Public Input No. 3597-NFPA 70-2023 [ Section No. 517.40 [Excluding any Sub-Sections] ]

Informational Note No. 1: Nursing homes and other limited care facilities can contain Category 1 and/or Category 2 patient care spaces, depending on the design and type of care administered in the facility. For Category 1 spaces, see 517.29 through 517.35. For Category 2 spaces not served by Type 1 essential electrical systems, see 517.40 through 517.44.

Informational Note No. 2: Type 2 essential electrical systems are comprised of two separate branches capable of supplying a limited amount of lighting and power service that is considered essential for the protection of life and safety and effective operation of the institution- ~~during the time normal electrical service is interrupted for any reason~~ . These two separate branches are the life safety and equipment branches. The number of transfer switches to be used should be based upon reliability, design, and load considerations. Each branch of the essential electrical system should have one or more transfer switches. One transfer switch and distribution system should be permitted to serve one or more branches in a facility with a maximum actual demand on the essential electrical system of 150 kVA (120 kW). [99:A.6.7.6.2.1]

### Statement of Problem and Substantiation for Public Input

This eliminates the reference to normal power, which is undefined.

### Submitter Information Verification

**Submitter Full Name:** Walter Vernon

**Organization:** Mazzetti

**Street Address:**

**City:**

**State:**

**Zip:**

**Submittal Date:** Tue Sep 05 05:35:50 EDT 2023

**Committee:** NEC-P15



## Public Input No. 2150-NFPA 70-2023 [ Section No. 517.41 ]

### 517.41 Required Power Sources.

#### (A) Independent Power Sources.

Essential electrical systems (EES) shall have two or more independent sources (or sets of sources). ~~One~~ In addition to the feeders or services called out in 517.4, each healthcare facility shall have one on-site source (or sets of sources) ~~shall be sized to supply the entire EES.~~ ~~The other independent~~ Both sources (entire site and EES) can share resources, however neither source (or sets of sources) shall be sized to supply the entire EES and shall be permitted to be located on-site or off-site. Additional sources other than the first two independent sources shall be permitted to be sized to supply the intended load depend on resources distribution equipment or pathways from the other to meet calculated load values for loads they are designated to feed.

Informational Note: An example of a set of sources may be several generators that combined serve the entire EES.

#### (B) Location of EES Components.

EES components shall be located to minimize interruptions caused by natural forces common to the area (e.g., storms, floods, earthquakes, or hazards created by adjoining structures or activities). [99:6.2.4.1]

Installations of electrical services shall be located to reduce possible interruption of normal electrical services resulting from similar causes as well as possible disruption of normal electrical service due to internal wiring and equipment failures. [99:6.2.4.2]

Feeders shall be located to provide physical separation of the feeders of the alternate source and from the feeders of the normal electrical source to prevent possible simultaneous interruption. [99:6.2.4.3]

## Statement of Problem and Substantiation for Public Input

In article 700 the NEC only recognizes generators as Emergency Power Sources (EPS), and states that on-site generator fuel is required. Based on the new code changes allowing Healthcare Microgrids as Emergency Power Sources (EPSs) this language is confusing and misleading. This proposed addition allows for other on-site energy producers to be utilized as part of the EES and requires fuel and battery storage requirements for these alternate on-site energy producers that are part of the EES. (The same revisions are proposed for Article 517.30)

## Related Public Inputs for This Document

<u>Related Input</u>	<u>Relationship</u>
<a href="#">Public Input No. 2132-NFPA 70-2023 [New Section after 517.1]</a>	
<a href="#">Public Input No. 1968-NFPA 70-2023 [Section No. 517.30]</a>	
<a href="#">Public Input No. 1968-NFPA 70-2023 [Section No. 517.30]</a>	
<a href="#">Public Input No. 2132-NFPA 70-2023 [New Section after 517.1]</a>	

## Submitter Information Verification

**Submitter Full Name:** Jamie Schnick  
**Organization:** OSHPD/HCAI



**Affiliation:** Office of Hospitals Planning and Development/Department of  
Healthcare Access and Information – California

**Street Address:**

**City:**

**State:**

**Zip:**

**Submittal Date:** Sun Aug 13 12:42:52 EDT 2023

**Committee:** NEC-P15



## Public Input No. 2152-NFPA 70-2023 [ Section No. 517.41 ]

### 517.41 Required Power Sources.

#### (A) Independent Power Sources.

Essential electrical systems (EES) shall have two or more independent sources (or sets of sources). One on-site source (or sets of sources) shall be sized to supply the entire EES. The other independent source (or sets of sources) shall be sized to supply the entire EES and shall be permitted to be located on-site or off-site. Additional sources other than the first two independent sources shall be permitted to be sized to supply the intended load.

Informational Note: An example of a set of sources may be several generators that combined serve the entire EES.

#### (B) Location of EES Components.

EES components shall be located to minimize interruptions caused by natural forces common to the area (e.g., storms, floods, earthquakes, or hazards created by adjoining structures or activities). [99:6.2.4.1]

Installations of electrical services shall be located to reduce possible interruption of normal electrical services resulting from similar causes as well as possible disruption of normal electrical service due to internal wiring and equipment failures. [99:6.2.4.2]

Feeders shall be located to provide physical separation of the feeders of the alternate source and from the feeders of the normal electrical source to prevent possible simultaneous interruption. [99:6.2.4.3]

#### (C) Power Sources for the EES.

Power sources for the EES shall be permitted to be any of those specific in 517.30(B)(1) through (B)(5).

## Statement of Problem and Substantiation for Public Input

The 2023 NEC revised Article 517.30 to allow an expanded list of acceptable power sources for the Type 1 essential electrical systems (EESs. 1) Utility Supply Power, 2) Generating Units, 3) Fuel Cell Systems, 4) Energy Storage Systems and 5) Health Care Microgrids. At this time the code was not revised for Type 2 EES's. We feel that the same opportunities for alternate energy sources should be extended for Nursing homes and limited care facilities.

The proposed revisions for the 2026 NEC would adopt the same options for Type 2 EES's as was developed for Type 1 EES's in the 2023 NEC Article 517.30.

## Submitter Information Verification

**Submitter Full Name:** Jamie Schnick  
**Organization:** OSHPD/HCAI  
**Affiliation:** Office of Hospitals Planning and Development/Department of Healthcare Access and Information – California  
**Street Address:**  
**City:**  
**State:**  
**Zip:**

**Submittal Date:** Sun Aug 13 13:12:44 EDT 2023

**Committee:** NEC-P15



## Public Input No. 2153-NFPA 70-2023 [ Section No. 517.41 ]

### 517.41 Required Power Sources.

#### (A) Independent Power Sources.

Essential electrical systems (EES) shall have two or more independent sources (or sets of sources). One on-site source (or sets of sources) shall be sized to supply the entire EES. The other independent source (or sets of sources) shall be sized to supply the entire EES and shall be permitted to be located on-site or off-site. Additional sources other than the first two independent sources shall be permitted to be sized to supply the intended load.

Informational Note: An example of a set of sources may be several generators that combined serve the entire EES.

#### (B) Location of EES Components.

EES components shall be located to minimize interruptions caused by natural forces common to the area (e.g., storms, floods, earthquakes, or hazards created by adjoining structures or activities). [99:6.2.4.1]

Installations of electrical services shall be located to reduce possible interruption of normal electrical services resulting from similar causes as well as possible disruption of normal electrical service due to internal wiring and equipment failures. [99:6.2.4.2]

Feeders shall be located to provide physical separation of the feeders of the alternate source and from the feeders of the normal electrical source to prevent possible simultaneous interruption. [99:6.2.4.3]

**(C) On-site energy storage systems and fuel supply.** The on-site EES sources (or set of sources) shall have sufficient resources on-site to provide continuous essential power to meet site requirements.

## Statement of Problem and Substantiation for Public Input

In article 700 the NEC only recognizes generators as Emergency Power Sources (EPS), and states that on site generator fuel is required. Based on the new code changes allowing Healthcare microgrids as EPS's this language is confusing and misleading.

This addition allows for other on- site energy producers to be utilized as part of the EES and requires fuel and battery storage requirements for these alternate on-site energy producers that are part of the EES. (The same revisions are proposed for Article 517.30)

## Related Public Inputs for This Document

<u>Related Input</u>	<u>Relationship</u>
<a href="#">Public Input No. 2106-NFPA 70-2023 [Section No. 517.30]</a>	
<a href="#">Public Input No. 2106-NFPA 70-2023 [Section No. 517.30]</a>	

## Submitter Information Verification

**Submitter Full Name:** Jamie Schnick  
**Organization:** OSHPD/HCAI  
**Affiliation:** Office of Hospitals Planning and Development/Department of Healthcare Access and Information – California

**Street Address:**

**City:**

**State:**

**Zip:**

**Submittal Date:** Sun Aug 13 13:13:51 EDT 2023

**Committee:** NEC-P15



## Public Input No. 2154-NFPA 70-2023 [ Section No. 517.41 ]

### 517.41 Required Power Sources.

#### (A) Independent Power Sources.

Essential electrical systems (EES) shall have two or more independent sources (or sets of sources). One on-site source (or sets of sources) shall be sized to supply the entire EES. The other independent source (or sets of sources) shall be sized to supply the entire EES and shall be permitted to be located on-site or off-site. Additional sources other than the first two independent sources shall be permitted to be sized to supply the intended load.

Informational Note: An example of a set of sources may be several generators that combined serve the entire EES.

#### (B) Location of EES Components.

EES components shall be located to minimize interruptions caused by natural forces common to the area (e.g., storms, floods, earthquakes, or hazards created by adjoining structures or activities). [99:6.2.4.1]

Installations of electrical services shall be located to reduce possible interruption of normal electrical services resulting from similar causes as well as possible disruption of normal electrical service due to internal wiring and equipment failures. [99:6.2.4.2]

Feeders shall be located to provide physical separation of the feeders of the alternate source and from the feeders of the normal electrical source to prevent possible simultaneous interruption. [99:6.2.4.3]

**(C) Temporary Source of Power for Maintenance or repair of the Alternate Source of Power.** The Essential Electrical System (EES) shall include permanent switching means to connect temporary or permanent on-site resources (energy sources or stored power supply systems) configured and sized adequately to provide power for EES, such that additional resources can be connected (without rewiring) to meet essential power requirements during individual on site resource equipment replacement, failures or maintenance.

## Statement of Problem and Substantiation for Public Input

With the new concept of multiple on-site sources (or sets of sources) there is the risk of one of the sources needing maintenance or repair which could render the Essential Electrical System (EES) sources inadequate to back-up the entire EES. This proposed revision would provide the capability to connect temporary or permanent resources to the EES (without rewiring) to allow the potential (repairs or maintenance) of the on-site alternate power resources to proceed without the risk of insufficient resources on site to back up all essential loads. (The same language is proposed for section 517.30)

## Related Public Inputs for This Document

<u>Related Input</u>	<u>Relationship</u>
<a href="#">Public Input No. 2108-NFPA 70-2023 [Section No. 517.30]</a>	
<a href="#">Public Input No. 2108-NFPA 70-2023 [Section No. 517.30]</a>	

## Submitter Information Verification

**Submitter Full Name:** Jamie Schnick  
**Organization:** OSHPD/HCAI

**Affiliation:** Office of Hospitals Planning and Development/Department of  
Healthcare Access and Information – California

**Street Address:**

**City:**

**State:**

**Zip:**

**Submittal Date:** Sun Aug 13 13:15:12 EDT 2023

**Committee:** NEC-P15



## Public Input No. 3598-NFPA 70-2023 [ Section No. 517.41 ]

### ~~517.41 – Required Power Sources.~~

#### ~~(A) – Independent Power Sources.~~

~~Essential electrical systems (EES) shall have two or more independent sources (or sets of sources). One on-site source (or sets of sources) shall be sized to supply the entire EES. The other independent source (or sets of sources) shall be sized to supply the entire EES and shall be permitted to be located on-site or off-site. Additional sources other than the first two independent sources shall be permitted to be sized to supply the intended load.~~

~~Informational Note: An example of a set of sources may be several generators that combined serve the entire EES.~~

#### ~~(B) – Location of EES Components.~~

~~EES components shall be located to minimize interruptions caused by natural forces common to the area (e.g., storms, floods, earthquakes, or hazards created by adjoining structures or activities). [ 99: 6.2.4.1]~~

~~Installations of electrical services shall be located to reduce possible interruption of normal electrical services resulting from similar causes as well as possible disruption of normal electrical service due to internal wiring and equipment failures. [ 99: 6.2.4.2]~~

~~Feeders shall be located to provide physical separation of the feeders of the alternate source and from the feeders of the normal electrical source to prevent possible simultaneous interruption. [ 99: 6.2.4.3]~~

## Statement of Problem and Substantiation for Public Input

This material is now better covered in 517-2.

## Submitter Information Verification

**Submitter Full Name:** Walter Vernon

**Organization:** Mazzetti

**Street Address:**

**City:**

**State:**

**Zip:**

**Submission Date:** Tue Sep 05 05:38:15 EDT 2023

**Committee:** NEC-P15





## Public Input No. 2151-NFPA 70-2023 [ Section No. 517.41(B) ]

### (B) Location of EES Components.

EES components shall be located to minimize interruptions caused by natural forces common to the area (e.g., storms, floods, earthquakes, or hazards created by adjoining structures or activities). [99:6.2.4.1]

Installations of electrical services shall be located to reduce possible interruption of normal electrical services resulting from similar causes as well as possible disruption of normal electrical service due to internal wiring and equipment failures. [99:6.2.4.2]

Feeders shall be located to provide physical separation of the feeders of the alternate source and from the feeders of the normal electrical source to prevent possible simultaneous interruption. [99:6.2.4.3]

Energy Storage Systems (ESSs) shall be located to provide physical separation of the ESS units from the essential distribution system and other on-site energy sources to prevent possible simultaneous interruption.

## Statement of Problem and Substantiation for Public Input

Catastrophic failure of battery storage systems has the potential to affect immediate surroundings with excessive heat. By requiring adequate separation of ESS's from the essential distribution systems and other on-site energy resources we will avoid the domino effect of multiple elements of the Essential Electrical system being disabled in the event of a battery fire. (The same language is proposed for section 517.30(C))

## Related Public Inputs for This Document

<u>Related Input</u>	<u>Relationship</u>
<a href="#">Public Input No. 2105-NFPA 70-2023 [Section No. 517.30(C)]</a>	
<a href="#">Public Input No. 2105-NFPA 70-2023 [Section No. 517.30(C)]</a>	

## Submitter Information Verification

**Submitter Full Name:** Jamie Schnick

**Organization:** OSHPD/HCAI

**Affiliation:** Office of Hospitals Planning and Development/Department of Healthcare Access and Information – California

**Street Address:**

**City:**

**State:**

**Zip:**

**Submittal Date:** Sun Aug 13 13:10:14 EDT 2023

**Committee:** NEC-P15



## Public Input No. 2992-NFPA 70-2023 [ Section No. 517.41(B) ]

### ~~(B)– Location of EES Components.~~

~~EES components shall be located to minimize interruptions caused by natural forces common to the area (e.g., storms, floods, earthquakes, or hazards created by adjoining structures or activities). [ 99: 6.2.4.1]~~

~~Installations of electrical services shall be located to reduce possible interruption of normal electrical services resulting from similar causes as well as possible disruption of normal electrical service due to internal wiring and equipment failures. [ 99: 6.2.4.2]~~

~~Feeders shall be located to provide physical separation of the feeders of the alternate source and from the feeders of the normal electrical source to prevent possible simultaneous interruption. [ 99: 6.2.4.3]~~

### Statement of Problem and Substantiation for Public Input

This public input is submitted on behalf of the Microgrid Task Group formed under the direction of the ELS Committee of NFPA 99 to provide correlation input to CMP-15 related to the use of microgrids and distributed energy resources in health care. The TG is also providing public inputs for consideration on any extracted language from 99 that has been modified in the 2024 edition of NFPA 99.

The extraction deals with location of ALL electrical components and not just EES components. The recommendation in related PI 2850 is to relocate this info about Location of Electrical System Components into Part I General. If that is done, this section can be deleted since those requirements in Part 1 will apply to all EES Types.

### Related Public Inputs for This Document

<u>Related Input</u>	<u>Relationship</u>
Public Input No. 2850-NFPA 70-2023 [Section No. 517.30(C)]	Action affects updates necessary in 517.41(B)

### Submitter Information Verification

**Submitter Full Name:** Chris Finen  
**Organization:** Eaton Corporation  
**Street Address:**  
**City:**  
**State:**  
**Zip:**  
**Submittal Date:** Mon Aug 28 14:46:23 EDT 2023  
**Committee:** NEC-P15



## Public Input No. 2155-NFPA 70-2023 [ Section No. 517.42 ]

### **517.42** Essential Electrical Systems for Nursing Homes and Limited Care Facilities.

#### **(A)** General.

The [Type 2] essential electrical system shall be divided into the following two branches:

- (1) Life safety branch
- (2) Equipment branch

[99:6.7.6.2.1.2]

The division between the branches shall occur at transfer switches where more than one transfer switch is required. [99:6.7.2.2.1]

Informational Note No. 1: Type 2 essential electrical systems are comprised of two separate branches capable of supplying a limited amount of lighting and power service that is considered essential for the protection of life and safety and effective operation of the institution during the time normal electrical service is interrupted for any reason. These two separate branches are the life safety and equipment branches.  
[99:A.6.7.6.2.1]

Informational Note No. 2: The number of transfer switches to be used should be based upon reliability, design, and load considerations. Each branch of the essential electrical system should have one or more transfer switches. One transfer switch should be permitted to serve one or more branches in a facility with a maximum demand on the essential electrical system of 150 kVA (120 kW). [99:A.6.7.6.2.1]

Informational Note No. 3: See NFPA 99-2021, *Health Care Facilities Code*, 6.7.2.2, for more information.

**(B) Transfer Switches.**

The number of transfer switches to be used shall be based upon reliability, design, and load considerations. [99:6.7.2.2.3]

Transfer switches shall be in accordance with one of the following:

- (1) Each branch of the essential electrical system shall have one or more transfer switches. [99:6.7.2.2.3.1]
- (2) One transfer switch shall be permitted to serve one or more branches in a facility with a continuous load on the switch of 150 kVA (120 kW) or less. [99:6.7.2.2.3.2]

Informational Note No. 1: See NFPA 99-2021, *Health Care Facilities Code*, 6.7.2.2.4, 6.7.2.2.5, 6.7.2.2.5.15, and 6.7.2.2.7 for more information on transfer switches.

Informational Note No. 2: See Informational Note Figure 517.42(B)(1).

Informational Note No. 3: See Informational Note Figure 517.42(B)(2).

**Figure Informational Note Figure 517.42(B)(1) Type 2 Essential Electrical Systems (Nursing Home and Limited Health Care Facilities) — Minimum Requirement (Greater Than 150 kVA) for Transfer Switch Arrangement.**

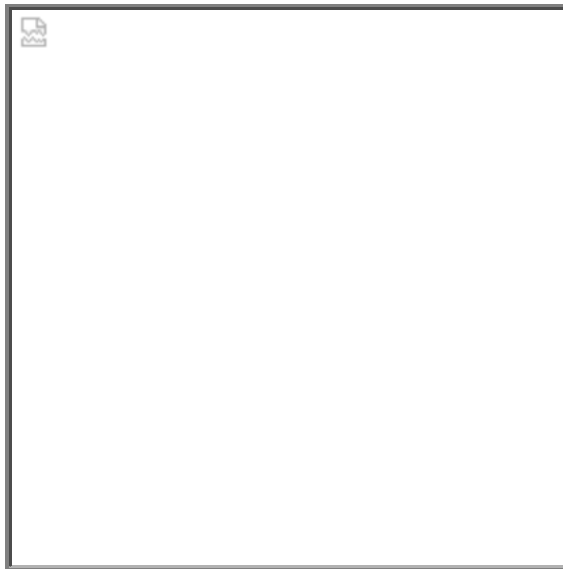

**Figure Informational Note Figure 517.42(B)(2) Type 2 Essential Electrical Systems (Nursing Home and Limited Health Care Facilities) — Minimum Requirement (150 kVA or Less) for Transfer Switch Arrangement.**

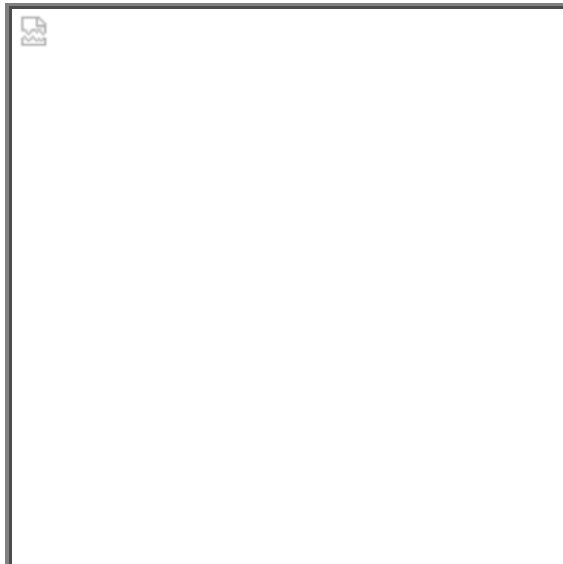

**(C) Capacity of System.**

The essential electrical system shall have capacity to meet the demand for the operation of all functions and equipment to be served by each branch at one time.

**(D) Separation from Other Circuits.**

The life safety branch and equipment branch shall be kept entirely independent of all other wiring and equipment. [99:6.7.6.3.1]

These circuits shall not enter the same raceways, boxes, or cabinets with other wiring except as follows:

- (1) In transfer switches
- (2) In exit or emergency luminaires supplied from two sources
- (3) In a common junction box attached to exit or emergency luminaires supplied from two sources

**(E) Receptacle Identification.**

The electrical receptacles or the cover plates for the electrical receptacles supplied from the life safety or equipment branches shall have a distinctive color or marking so as to be readily identifiable. [99:6.7.6.3.2]

Informational Note: If color is used to identify these receptacles, the same color should be used throughout the facility. [ 99: A.6.7.6.3.2]

(F) Coordination. [OSHPD 2, 4 & 5] Overcurrent protective devices serving the essential electrical system shall be coordinated for the period of time that a fault's duration extends beyond 0.1 second.

Exception No. 1: Between transformer primary and secondary overcurrent protective devices, where only one overcurrent protective device or set of overcurrent protective devices exists on the transformer secondary.

Exception No. 2: Between overcurrent protective devices of the same size (ampere rating) in series.

Informational Note 1: The terms coordination and coordinated as used in this section do not cover the full range of overcurrent conditions.

Informational Note No. 2: See 517.17(C) for information on requirements for the coordination of ground-fault protection.

## Statement of Problem and Substantiation for Public Input

The current NEC (517.31(G)) has provisions to relax the coordination requirements for Overcurrent Protection Devices (OCPD's) for Type 1 essential electrical systems, coordination is only required for the period of time that a fault's duration extends beyond 0.1 second for hospital essential electrical systems. This allowance is not currently in the code for nursing homes and limited care facilities. We feel that this is a mistake.

We feel that the relaxation of coordination requirements (over Article 700 coordination requirements) should be extended for Nursing homes and limited care facilities.

The proposed revisions would adopt the same allowances for coordination of OCPD's for Type 2 EES's (nursing homes and limited care facilities) as exists for Type 1 EES's (hospitals).

(Note: no change to the Informational note, autoforamtting issue has it underlined)

## Submitter Information Verification

**Submitter Full Name:** Jamie Schnick

**Organization:** OSHPD/HCAI

**Affiliation:** Office of Hospitals Planning and Development/Department of  
Healthcare Access and Information – California

**Street Address:**

**City:**

**State:**

**Zip:**

**Submittal Date:** Sun Aug 13 13:56:52 EDT 2023

**Committee:** NEC-P15



## Public Input No. 3599-NFPA 70-2023 [ Section No. 517.42(A) ]

### (A) General.

The [Type 2] essential electrical system shall be divided into the following two branches:

- (1) Life safety branch
- (2) Equipment branch

[99:6.7.6.2.1.2]

The division between the branches shall occur at transfer switches where more than one transfer switch is required. [99:6.7.2.2.1]

Informational Note No. 1: Type 2 essential electrical systems are comprised of two separate branches capable of supplying a limited amount of lighting and power service that is considered essential for the protection of life and safety and effective operation of the institution- during the time normal electrical service is interrupted for any reason .

These two separate branches are the life safety and equipment branches.

[99:A.6.7.6.2.1]

~~Informational Note No. 2: The number of transfer switches to be used should be based upon reliability, design, and load considerations. Each branch of the essential electrical system should have one or more transfer switches. One transfer switch should be permitted to serve one or more branches in a facility with a maximum demand on the essential electrical system of 150 kVA (120 kW). [ 99: A.6.7.6.2.1] Informational Note~~

~~No. 3: See NFPA 99-2021, *Health Care Facilities Code*, 6.7.2.2, for more information.~~

## Statement of Problem and Substantiation for Public Input

Eliminates the term. normal. Informational note 2 is duplicative of the section that follows.

## Submitter Information Verification

**Submitter Full Name:** Walter Vernon

**Organization:** Mazzetti

**Street Address:**

**City:**

**State:**

**Zip:**

**Submission Date:** Tue Sep 05 05:39:46 EDT 2023

**Committee:** NEC-P15



**Public Input No. 2110-NFPA 70-2023 [ Section No. 517.42(B) ]**

A large, empty rectangular box with a thin black border, intended for public input or comments.



**(B)** Transfer Switches.

The number of transfer switches to be used shall be based upon reliability, design, and load considerations. [99:6.7.2.2.3]

Transfer switches shall be in accordance with one of the following:

- (1) Each branch of the essential electrical system shall have one or more transfer switches. [99:6.7.2.2.3.1]
- (2) One transfer switch shall be permitted to serve one or more branches in a facility with a continuous essential electrical system load ~~on the switch~~ of 150 kVA (120 kW) or less. [99:6.7.2.2.3.2]

Informational Note No. 1: See NFPA 99-2021, *Health Care Facilities Code*, 6.7.2.2.4, 6.7.2.2.5, 6.7.2.2.5.15, and 6.7.2.2.7 for more information on transfer switches.

Informational Note No. 2: See Informational Note Figure 517.42(B)(1).

Informational Note No. 3: See Informational Note Figure 517.42(B)(2).

**Figure Informational Note Figure 517.42(B)(1) Type 2 Essential Electrical Systems (Nursing Home and Limited Health Care Facilities) — Minimum Requirement (Greater Than 150 kVA) for Transfer Switch Arrangement.**

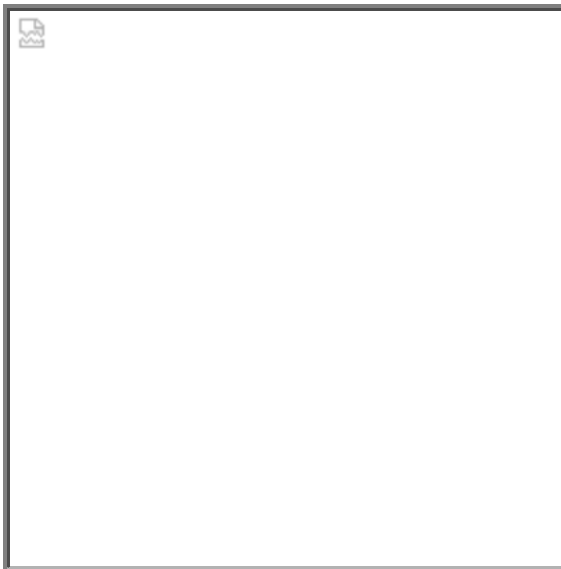

**Figure Informational Note Figure 517.42(B)(2) Type 2 Essential Electrical Systems (Nursing Home and Limited Health Care Facilities) — Minimum Requirement (150 kVA or Less) for Transfer Switch Arrangement.**

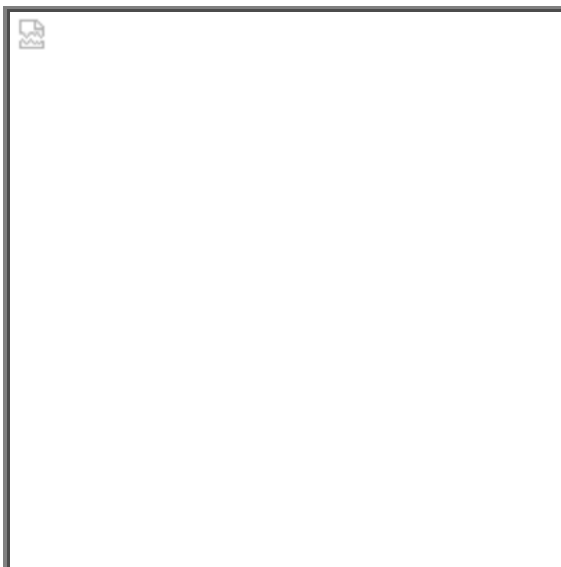

## Statement of Problem and Substantiation for Public Input

There is a potential for this to be misinterpreted. By stating that the threshold for requiring multiple transfer switches is the facilities essential electrical system load, it clarifies that the individual ATS sizing does not drive the need for multiple ATSs but the overall EES load is the driving factor. It appears that this was the intent of the code section as written. We recommend this change to avoid confusion on code interpretation. (Similar to 2109 for Hospitals)

## Related Public Inputs for This Document

<u>Related Input</u>	<u>Relationship</u>
<u>Public Input No. 2109-NFPA 70-2023 [Section No. 517.31(B) [Excluding any Sub-Sections]]</u>	
<u>Public Input No. 2109-NFPA 70-2023 [Section No. 517.31(B) [Excluding any Sub-Sections]]</u>	

## Submitter Information Verification

**Submitter Full Name:** Jamie Schnick

**Organization:** OSHPD/HCAI

**Affiliation:** Office of Hospitals Planning and Development/Department of Healthcare Access and Information – California

**Street Address:**

**City:**

**State:**

**Zip:**

**Submittal Date:** Sat Aug 12 08:24:54 EDT 2023

**Committee:** NEC-P15



**Public Input No. 3600-NFPA 70-2023 [ Section No. 517.42(B) ]**

A large, empty rectangular box with a thin border, intended for public input or comments.

**(B) Transfer Switches.**

The number of transfer switches to be used shall be based upon reliability, design, and load considerations. [99:6.7.2.2.3]

Transfer switches shall be in accordance with one of the following:

- (1) Each branch of the essential electrical system shall have one or more transfer switches. [99:6.7.2.2.3.1]
- (2) The number of transfer switches to be used should be based upon reliability, design, and load considerations. Each branch of the essential electrical system should have one or more transfer switches. One transfer switch shall should be permitted to serve one or more branches in a facility with a continuous load maximum actual demand on the switch- essential electrical system of 150 kVA (120 kW) - or less .  
[ 99: 6 A . 6 . 7 . 2 6 . 2 . 3-2 1 ]

Informational Note No. 1: See NFPA 99-2021, *Health Care Facilities Code*, 6.7.2.2.4, 6.7.2.2.5, 6.7.2.2.5.15, and 6.7.2.2.7 for more information on transfer switches.

Informational Note No. 2: See Informational Note Figure 517.42(B)(1) .

Informational Note No. 3: See Informational Note Figure 517.42(B)(2) .

**Figure Informational Note Figure 517.42(B)(1) Type 2 Essential Electrical Systems (Nursing Home and Limited Health Care Facilities) — Minimum Requirement (Greater Than 150 kVA) for Transfer Switch Arrangement.**

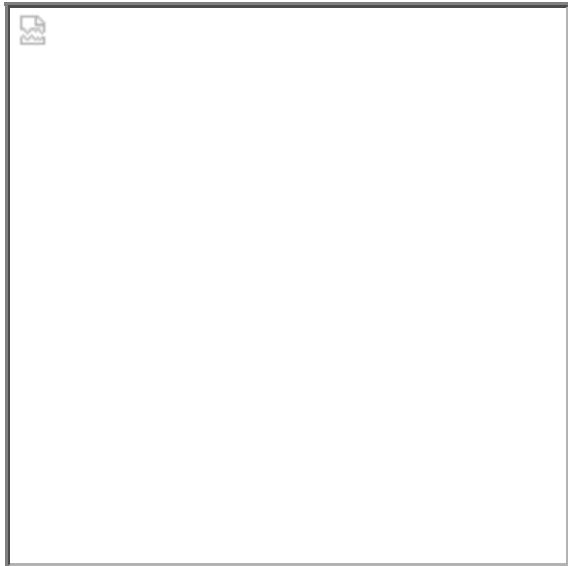

**Figure Informational Note Figure 517.42(B)(2) Type 2 Essential Electrical Systems (Nursing Home and Limited Health Care Facilities) — Minimum Requirement (150 kVA or Less) for Transfer Switch Arrangement.**



### Statement of Problem and Substantiation for Public Input

i think these diagrams should be replaced by the one in 2515; or, if we want to keep them here, modify to coordinate.

### Submitter Information Verification

**Submitter Full Name:** Walter Vernon

**Organization:** Mazzetti

**Street Address:**

**City:**

**State:**

**Zip:**

**Submittal Date:** Tue Sep 05 05:43:06 EDT 2023

**Committee:** NEC-P15



## Public Input No. 3601-NFPA 70-2023 [ Section No. 517.42(C) ]

**(C)– Capacity of System.**

The essential electrical system shall have capacity to meet the demand for the operation of all functions and equipment to be served by each branch at one time.

### Statement of Problem and Substantiation for Public Input

This section is now replaced by 517-2.

### Related Public Inputs for This Document

<u>Related Input</u>	<u>Relationship</u>
<u>Public Input No. 2515-NFPA 70-2023 [New Section after 517.1]</u>	2515 replaces this text.

### Submitter Information Verification

**Submitter Full Name:** Walter Vernon

**Organization:** Mazzetti

**Street Address:**

**City:**

**State:**

**Zip:**

**Submission Date:** Tue Sep 05 05:46:04 EDT 2023

**Committee:** NEC-P15





## Public Input No. 1036-NFPA 70-2023 [ Section No. 517.42(E) ]

### (E) Receptacle Identification.

The electrical receptacles or the cover plates for the electrical receptacles supplied from the life safety or shall be identified in yellow every 10 feet, and equipment branches shall ~~have a distinctive color or marking so~~ be identified in green every 10 feet so as to be readily identifiable. [99:6.7.6.3.2]

Informational Note: If color is used to identify these receptacles, the same color should be used throughout the facility. [99:A.6.7.6.3.2]

### Statement of Problem and Substantiation for Public Input

Again having color coding in the NEC is a must.

Labeling the conduits every 10 feet will help the inspector follow conduits, and will hopefully stop electrical installation on the life safety, equipment, and critical branches from installation that are not part of these systems.

### Submitter Information Verification

**Submitter Full Name:** John Plourde

**Organization:** Portsmouth Nh City Of

**Affiliation:** Performance Electrical Training LLC.

**Street Address:**

**City:**

**State:**

**Zip:**

**Submittal Date:** Mon Jun 12 14:07:47 EDT 2023

**Committee:** NEC-P15



## Public Input No. 2993-NFPA 70-2023 [ Section No. 517.43 ]

### **517.43** Automatic Connection to Life Safety and Equipment Branch.

The life safety and equipment branches shall be installed and connected to the ~~alternate on-site~~ source of power specified in 517.41 so that all functions specified herein for the life safety and equipment branches are automatically restored to operation within 10 seconds after interruption of the ~~normal source power~~ . [99:6.7.6.4.1]

No functions other than those listed in 517.43(A) through (G) shall be connected to the life safety branch. [99:6.7.6.2.1.5(D)]

The life safety branch shall supply power as follows:

#### **(A)** Illumination of Means of Egress.

Illumination of means of egress as is necessary for corridors, passageways, stairways, landings, and exit doors and all ways of approach to exits. Switching arrangement to transfer patient corridor lighting from general illumination circuits shall be permitted if only one of two circuits can be selected and both circuits cannot be extinguished at the same time.

Informational Note: See NFPA 101-2021, *Life Safety Code*, Sections 7.8 and 7.9.

#### **(B)** Exit Signs.

Exit signs and exit directional signs.

Informational Note: See NFPA 101-2021, *Life Safety Code*, Section 7.10.

#### **(C)** Alarm and Alerting Systems.

Alarm and alerting systems, including the following:

##### (1) Fire alarms

Informational Note No. 1: See NFPA 101-2021, *Life Safety Code*, Sections 9.6 and 18.3.4.

##### (2) Alarms required for systems used for the piping of nonflammable medical gases

Informational Note No. 2: See NFPA 99-2021, *Health Care Facilities Code*, 6.7.5.1.2.5.

#### **(D)** Communications Systems.

Communications systems, where used for issuing instructions during emergency conditions. [99:6.7.5.6.2.1.2.5(4)(3)]

#### **(E)** Generator Set Location.

Task illumination and select receptacles at the generator set location and essential electrical system transfer switch locations.

#### **(F)** Elevators.

Elevator cab lighting, control, communications, and signal systems. [99:6.7.5.6.2.1.2.4.5(A)(6)]

#### **(G)** AC Equipment for Nondelayed Automatic Connection.

Generator accessories, including, but not limited to, the transfer fuel pump, electrically operated louvers, and other generator accessories essential for generator operation shall be arranged for automatic connection to the ~~alternate on-site~~ power source. [99:6.7.6.2.1.6(C)]

## Statement of Problem and Substantiation for Public Input

This public input is submitted on behalf of the Microgrid Task Group formed under the direction of the ELS Committee of NFPA 99 to provide correlation input to CMP-15 related to the use of microgrids and distributed energy resources in health care. The TG is also providing public inputs for consideration on any extracted language from 99 that has been modified in the 2024 edition of NFPA 99.

Replace "alternate" with "on-site" to match extraction language. Extraction reference needs to be updated to the correct location in 2024 NFPA 99.

### Submitter Information Verification

**Submitter Full Name:** Chris Finen

**Organization:** Eaton Corporation

**Street Address:**

**City:**

**State:**

**Zip:**

**Submittal Date:** Mon Aug 28 14:58:38 EDT 2023

**Committee:** NEC-P15



## Public Input No. 2115-NFPA 70-2023 [ Section No. 517.43(D) ]

### (D) Communications Systems.

(1) Communications systems, where used for issuing instructions during emergency conditions.  
[99:6.7.5.1.2.4(3)]

(2) Emergency Responder Radion Communication Systems (ERRCs)

### Statement of Problem and Substantiation for Public Input

There is a federal requirement for all buildings to have radio coverage for first responders and emergency service personnel. Frequently this requires Public safety distributed antenna systems (DAS) often referred to as an Emergency Responder Radio Coverage System (ERRCS) which is a wireless communications system that's used exclusively by first responders and emergency service personnel, to be installed in healthcare buildings. The circuiting for the ERRCS is not currently covered in the code. We recommend we add this as required to be fed by the life safety branch of the Essential electrical system, as this is a fire and life safety load. (Similar to P.I. 2114 for Hospitals)

### Related Public Inputs for This Document

<u>Related Input</u>	<u>Relationship</u>
<a href="#">Public Input No. 2114-NFPA 70-2023 [Section No. 517.33(D)]</a>	
<a href="#">Public Input No. 2114-NFPA 70-2023 [Section No. 517.33(D)]</a>	

### Submitter Information Verification

**Submitter Full Name:** Jamie Schnick

**Organization:** OSHPD/HCAI

**Affiliation:** Office of Hospitals Planning and Development/Department of Healthcare Access and Information – California

**Street Address:**

**City:**

**State:**

**Zip:**

**Submittal Date:** Sat Aug 12 09:35:39 EDT 2023

**Committee:** NEC-P15



## Public Input No. 3602-NFPA 70-2023 [ Section No. 517.43(E) ]

(E)– ~~Generator-Set Location~~ Power Source Location .

Task illumination and select receptacles at the ~~generator-set location-~~ power source location and essential electrical system transfer switch locations.

### Statement of Problem and Substantiation for Public Input

This requirement should apply to all sources.

### Submitter Information Verification

**Submitter Full Name:** Walter Vernon

**Organization:** Mazzetti

**Street Address:**

**City:**

**State:**

**Zip:**

**Submittal Date:** Tue Sep 05 05:47:43 EDT 2023

**Committee:** NEC-P15



## Public Input No. 2997-NFPA 70-2023 [ Section No. 517.44 ]

### 517.44 Connection to Equipment Branch.

The equipment branch shall be installed and connected to the ~~alternate power~~ on-site power source such that equipment described in 517.35(A)(6) is automatically restored to operation at appropriate time-lag intervals following the energizing of the life safety and critical branches. [99:6.7.5.6.2.1.4.2.6(A)]

The equipment branch arrangement shall also provide for the additional connection of equipment listed in 517.44(B).

*Exception: For essential electrical systems under 150 kVA, deletion of the time-lag intervals feature for delayed automatic connection to the equipment branch shall be permitted.*

#### (A) Delayed Automatic Connections to Equipment Branch.

The following equipment shall be permitted to be connected to the equipment branch and shall be arranged for delayed automatic connection to the ~~alternate~~ on-site power source:

- (1) Task illumination and select receptacles in the following: [99:6.7.6.2.1.6(D)(1)]
  - (2) Patient care spaces [ 99: 6.7.6.2.1.6(D)(1)(a)]
  - (3) Medication preparation spaces

[ 99: 6.7.6.2.1.6(D)(1)(b)]

- (4) Pharmacy dispensing space [ 99: 6.7.6.2.1.6(D)(1)(c)]
- (5) Nurses' stations — unless adequately lighted by corridor luminaires [ 99: 6.7.6.2.1.6(D)(1)(d)]
- (6) Supply, return, and exhaust ventilating systems for airborne infectious isolation rooms [99:6.7.6.2.1.6(D)(2)]
- (7) Sump pumps and other equipment required to operate for the safety of major apparatus and associated control systems and alarms [99:6.7.6.2.1.6(D)(3)]
- (8) Smoke control and stair pressurization systems [99:6.7.6.2.1.6(D)(4)]
- (9) Kitchen hood supply or exhaust systems, or both, if required to operate during a fire in or under the hood [99:6.7.6.2.1.6(D)(5)]
- (10) Nurse call systems [99:6.7.6.2.1.6(D)(6)]
- (11) HVAC systems serving the EF, TER, and TR [99:6.7.6.2.1.6 ( D)(7)]

#### (B) Delayed-Automatic or Manual Connection to the Equipment Branch.

The equipment specified in 517.44(B)(1) through (B)(4) shall be permitted to be connected to the equipment branch and shall be arranged for either delayed-automatic or manual connection to the ~~alternate~~ on-site power source.

**(1) Heating Equipment to Provide Heating for General Patient Rooms.**

Heating of general patient rooms during disruption of the normal source shall not be required under any of the following conditions:

- (1) The outside design temperature is higher than  $-6.7^{\circ}\text{C}$  ( $20^{\circ}\text{F}$ ).
- (2) The outside design temperature is lower than  $-6.7^{\circ}\text{C}$  ( $20^{\circ}\text{F}$ ) and, where a selected room(s) is provided for the needs of all confined patients, then only such room(s) need be heated.
- (3) The facility is served by a dual source of normal power as described in 517.30(C), Informational Note.

Informational Note: The outside design temperature is based on the 97.5 percent design values, as shown in Chapter 24 of the ASHRAE *Handbook of Fundamentals* (2013).

**(2) Elevator Service.**

In instances where interruptions of power would result in elevators stopping between floors, throw-over facilities shall be provided to allow the temporary operation of any elevator for the release of passengers.

**(3) Optional Connections to the Equipment Branch.**

Additional illumination, receptacles, and equipment shall be permitted to be connected only to the equipment branch.

**(4) Multiple Systems.**

Where one switch serves multiple systems as permitted in 517.43, transfer for all loads shall be nondelayed automatic.

[99:6.7.6.2.1.6(E)]

Informational Note: See 517.43(G) for elevator cab lighting, control, and signal system requirements. [99:A.6.7.6.2.1.6(E)(2)]

## Statement of Problem and Substantiation for Public Input

This public input is submitted on behalf of the Microgrid Task Group formed under the direction of the ELS Committee of NFPA 99 to provide correlation input to CMP-15 related to the use of microgrids and distributed energy resources in health care. The TG is also providing public inputs for consideration on any extracted language from 99 that has been modified in the 2024 edition of NFPA 99.

Replace "alternate" with "on-site" to match extraction language. Extraction reference needs to be updated to the correct location in 2024 NFPA 99. First reference in 517.44 was updated to point to Type 2 EES section of 99 instead of Type 1 EES section. New sub item (7) was added 517.44 (A) pertaining to HVAC systems because it was missing from the extracted language.

## Submitter Information Verification

**Submitter Full Name:** Chris Finen

**Organization:** Eaton Corporation

**Street Address:**

**City:**

**State:**

**Zip:**

**Submission Date:** Mon Aug 28 15:11:42 EDT 2023

**Committee:** NEC-P15



## Public Input No. 2156-NFPA 70-2023 [ Section No. 517.44(A) ]

### (A) Delayed Automatic Connections to Equipment Branch.

The following equipment shall be ~~permitted to be~~ connected to the equipment branch and shall be ~~permitted to be~~ arranged for delayed automatic connection to the alternate power source:

- (1) Task illumination and select receptacles in the following: [99:6.7.6.2.1.6(D)(1)]
  - (2) Patient care spaces [ 99: 6.7.6.2.1.6(D)(1)(a)]
  - (3) Medication preparation spaces  
  
[ 99: 6.7.6.2.1.6(D)(1)(b)]
  - (4) Pharmacy dispensing space [ 99: 6.7.6.2.1.6(D)(1)(c)]
  - (5) Nurses' stations — unless adequately lighted by corridor luminaires  
[ 99: 6.7.6.2.1.6(D)(1)(d)]
- (6) Supply, return, and exhaust ventilating systems for airborne infectious isolation rooms [99:6.7.6.2.1.6(D)(2)]
- (7) Sump pumps and other equipment required to operate for the safety of major apparatus and associated control systems and alarms [99:6.7.6.2.1.6(D)(3)]
- (8) Smoke control and stair pressurization systems [99:6.7.6.2.1.6(D)(4)]
- (9) Kitchen hood supply or exhaust systems, or both, if required to operate during a fire in or under the hood [99:6.7.6.2.1.6(D)(5)]
- (10) Nurse call systems [99:6.7.6.2.1.6(D)(6)]

## Statement of Problem and Substantiation for Public Input

The placement of the phrase "permitted to be" appears to be incorrect.

As the sentence currently reads it could be interpreted to say, that the equipment is permitted to be connected to the equipment branch but is not required to be connected to the equipment branch. I believe the intent is to say that the configuration Delayed Automatic "shall be permitted" connections. We feel that the proposed revisions will meet the intent of the code and clear up any confusion on the interpretation of this code section.

## Submitter Information Verification

**Submitter Full Name:** Jamie Schnick  
**Organization:** OSHPD/HCAI  
**Affiliation:** Office of Hospitals Planning and Development/Department of Healthcare Access and Information – California  
**Street Address:**



**City:**

**State:**

**Zip:**

**Submittal Date:** Sun Aug 13 14:15:03 EDT 2023

**Committee:** NEC-P15



## Public Input No. 3350-NFPA 70-2023 [ Section No. 517.45(A) ]

### (A) Essential Electrical Distribution.

If required by the governing body, the essential electrical distribution system for Category 3 patient care spaces shall be comprised of an ~~alternate~~ on-site power system capable of supplying a limited amount of lighting and power service for the orderly cessation of procedures during ~~a time normal electrical service is interrupted~~ an interruption of power .

Informational Note: See NFPA 99-2024 2024 , *Health Care Facilities Code*.

### Statement of Problem and Substantiation for Public Input

This public input is submitted on behalf of the Microgrid Task Group formed under the direction of the ELS Committee of NFPA 99 to provide correlation input to CMP-15 related to the use of microgrids and distributed energy resources in health care. The TG is also providing public inputs for consideration on any extracted language from 99 that has been modified in the 2024 edition of NFPA 99.

Replace "alternate" with "on-site" and eliminated "normal" to align language around sources with NFPA 99.

### Submitter Information Verification

**Submitter Full Name:** Chris Finen

**Organization:** Eaton Corporation

**Street Address:**

**City:**

**State:**

**Zip:**

**Submittal Date:** Fri Sep 01 14:15:55 EDT 2023

**Committee:** NEC-P15



## Public Input No. 3603-NFPA 70-2023 [ Section No. 517.45(A) ]

### (A) Essential Electrical Distribution.

If required by the governing body, the essential electrical distribution system for Category 3 patient care spaces shall be comprised of ~~an alternate power~~ a power system capable of supplying a limited amount of lighting and power service for the orderly cessation of procedures ~~during a time normal electrical service is interrupted~~ .

Informational Note: See NFPA 99-2021, *Health Care Facilities Code*.

### Statement of Problem and Substantiation for Public Input

Correlates terminology with NFPA 99.

### Submitter Information Verification

**Submitter Full Name:** Walter Vernon

**Organization:** Mazzetti

**Street Address:**

**City:**

**State:**

**Zip:**

**Submittal Date:** Tue Sep 05 05:50:13 EDT 2023

**Committee:** NEC-P15



## Public Input No. 3014-NFPA 70-2023 [ Section No. 517.45(E) ]

### (E) Power Systems.

If required, ~~alternate~~ on-site power sources acceptable to the governing body shall comply with the requirements of NFPA 99-2024 2024 , *Health Care Facilities Code*.

### Statement of Problem and Substantiation for Public Input

This public input is submitted on behalf of the Microgrid Task Group formed under the direction of the ELS Committee of NFPA 99 to provide correlation input to CMP-15 related to the use of microgrids and distributed energy resources in health care. The TG is also providing public inputs for consideration on any extracted language from 99 that has been modified in the 2024 edition of NFPA 99.

To support the use of various types of power sources, distributed energy resources, and microgrids, the terms "alternate" and "normal" need to be replaced with more generic terms for power sources such as "on-site" and "off-site".

### Submitter Information Verification

**Submitter Full Name:** Chris Finen

**Organization:** Eaton Corporation

**Street Address:**

**City:**

**State:**

**Zip:**

**Submittal Date:** Mon Aug 28 16:56:35 EDT 2023

**Committee:** NEC-P15



## Public Input No. 3604-NFPA 70-2023 [ Section No. 517.45(E) ]

(E) – Power Systems.

If required, alternate power sources acceptable to the governing body shall comply with the requirements of NFPA 99-2021, *Health Care Facilities Code*.

### Statement of Problem and Substantiation for Public Input

I think this section does not help us.

### Submitter Information Verification

**Submitter Full Name:** Walter Vernon

**Organization:** Mazzetti

**Street Address:**

**City:**

**State:**

**Zip:**

**Submittal Date:** Tue Sep 05 05:51:48 EDT 2023

**Committee:** NEC-P15



## Public Input No. 2301-NFPA 70-2023 [ Section No. 517.63(A) ]

### (A)– Battery- Powered Lighting Units Equipped Emergency Luminaires .

One or more listed battery-powered lighting units shall be provided and shall be permitted to be equipped emergency luminaires shall be wired to the critical lighting circuit in the area and connected ahead of any local switches.

## Statement of Problem and Substantiation for Public Input

The NEC 100 definition of “battery-powered lighting units”, associated with Art. 517, describes the design and intended function of equipment well-known within the emergency lighting community as “unit equipment.” In the 2023 revision cycle, unit equipment was recognized as a type of battery-equipped emergency luminaire, and the (relocated to Article 100) definition was updated accordingly. To promote the consistent use of terminology throughout the NEC, the term “battery-powered lighting unit” should be replaced with the broader term “battery-equipped emergency luminaire” because the intended functionality – to automatically illuminate when the monitored normal power circuit is disrupted – can be accomplished by more than just unit equipment.

Anesthetizing locations (517.63) should not be precluded from using battery-equipped emergency luminaires that also function for normal lighting purposes; for example, ceiling or recessed-ceiling mounted luminaires with integral battery backup power. Unit equipment (and, as currently defined, an “emergency battery-powered lighting unit”) is a separate device mounted on the wall and only illuminates when normal power is lost. There is no reason for anesthetizing locations to be precluded from adopting the more space and cost-efficient emergency lighting solutions widely used in other locations.

The revision to 517.33(E)(2) brings the same allowance for a generator set location to utilize the broader range of battery-equipped emergency luminaires rather than be restricted to the use of only unit equipment.

See also related PI XXX (100).

## Related Public Inputs for This Document

<u>Related Input</u>	<u>Relationship</u>
<a href="#">Public Input No. 2299-NFPA 70-2023 [Definition: Battery-Powered Lighting Units.]</a>	
<a href="#">Public Input No. 2300-NFPA 70-2023 [Section No. 517.33(E)]</a>	
<a href="#">Public Input No. 2299-NFPA 70-2023 [Definition: Battery-Powered Lighting Units.]</a>	
<a href="#">Public Input No. 2300-NFPA 70-2023 [Section No. 517.33(E)]</a>	

## Submitter Information Verification

**Submitter Full Name:** Michael Shulman

**Organization:** UL Solutions

**Street Address:**

**City:**

**State:**

**Zip:**

**Submittal Date:** Tue Aug 15 18:06:22 EDT 2023  
**Committee:** NEC-P15



## Public Input No. 2919-NFPA 70-2023 [ Section No. 517.63(B) ]

### (B) Branch-Circuit Wiring.

Branch circuits supplying only listed, fixed, therapeutic and diagnostic equipment, permanently installed above the hazardous (classified) location and in unclassified locations, shall be permitted to be supplied from a normal grounded service, single- or ~~three-phase~~ polyphase system, provided the following apply:

- (1) Wiring for grounded and isolated circuits does not occupy the same raceway or cable.
- (2) All conductive surfaces of the equipment are connected to an equipment grounding conductor.
- (3) Equipment (except enclosed X-ray tubes and the leads to the tubes) is located at least 2.5 m (8 ft) above the floor or outside the anesthetizing location.
- (4) Switches for the grounded branch circuit are located outside the hazardous (classified) location.

*Exception: Sections 517.63(B)(3) and (B)(4) shall not apply in unclassified locations.*

### Statement of Problem and Substantiation for Public Input

While three phase is the most common polyphase system other types may be present at older facilities such as two phase. There is no need to exclude these other types of systems.

### Submitter Information Verification

**Submitter Full Name:** Stephen Schmiechen

**Organization:** [ Not Specified ]

**Street Address:**

**City:**

**State:**

**Zip:**

**Submittal Date:** Sun Aug 27 17:56:34 EDT 2023

**Committee:** NEC-P15





## Public Input No. 1273-NFPA 70-2023 [ Section No. 517.70 ]

### **517.70** Applicability.

~~Nothing in this part shall be construed as specifying safeguards against possible radiation or magnetic fields.~~

#### **Diagnostic imaging and treatment equipment shall comply with Part V of this article.**

Informational Note No. 1: Radiation safety and performance requirements of several classes of X-ray equipment are regulated under Public Law 90-602 and are enforced by the Department of Health and Human Services.

Informational Note No. 2: Information on radiation protection by the National Council on Radiation Protection and Measurements is published as *Reports of the National Council on Radiation Protection and Measurement*. These reports are obtainable from NCRP Publications, P.O. Box 30175, Washington, DC 20014.

Informational Note No. 3: Examples of diagnostic imaging equipment can include, but are not limited to, the following:

- (1) General radiographic (X-ray) equipment (mobile and fixed)
- (2) General fluoroscopic equipment (mobile and fixed)
- (3) Interventional equipment (mobile and fixed)
- (4) Bone mineral density equipment
- (5) Dental equipment
- (6) Computerized tomography (CT) equipment
- (7) Positron emission tomography (PET) equipment
- (8) Nuclear medicine equipment
- (9) Mammography equipment
- (10) Magnetic resonance (MR) equipment
- (11) Diagnostic ultrasound equipment
- (12) Electrocardiogram equipment

Informational Note No. 4: Examples of treatment equipment can include, but are not limited to, the following:

- (1) Linear accelerators
- (2) Gamma knife
- (3) Cyber knife
- (4) Proton therapy
- (5) Tomotherapy

### **Statement of Problem and Substantiation for Public Input**

This PI seeks to replace what appears to be a legal warning with an enforceable NEC requirement. If the content marked for deletion is really worth retaining it should be an informational note and the word "shall" should be removed from it.

### **Submitter Information Verification**

**Submitter Full Name:** Ryan Jackson  
**Organization:** Self-employed  
**Street Address:**  
**City:**  
**State:**  
**Zip:**  
**Submittal Date:** Tue Jul 04 13:30:20 EDT 2023  
**Committee:** NEC-P15



## Public Input No. 2750-NFPA 70-2023 [ Section No. 517.71(C) ]

(C) Over 1000-Volt Supply.

Circuits and equipment operated on a supply circuit of over 1000 volts shall comply with [Article 495](#), Parts I through IV- of ~~Article 495~~ .

### Statement of Problem and Substantiation for Public Input

This Public Input is being submitted on behalf of the NEC Correlating Committee Usability Task Group in order to provide correlation throughout the document. The text is revised to to comply with the NEC Style Manual Section 4.1.4, regarding the use of Parts.

4.1.4 References to an Entire Article. References shall not be made to an entire article, except for the Article 100 or where referenced to provide the necessary context. References to specific parts within articles shall be permitted. References to all parts of an article shall not be permitted. The article number shall precede the part number.

The Usability Task Group members are: Derrick Atkins, David Hittinger, Richard Holub, Dean Hunter, Chad Kennedy and David Williams.

### Submitter Information Verification

**Submitter Full Name:** David Williams

**Organization:** Delta Charter Township

**Street Address:**

**City:**

**State:**

**Zip:**

**Submittal Date:** Thu Aug 24 19:55:47 EDT 2023

**Committee:** NEC-P15



## Public Input No. 88-NFPA 70-2023 [ Section No. 517.72(B) ]

### (B) Location.

The disconnecting means shall be operable from a location ~~readily accessible~~ within sight of and not more than 10' from the control ~~location~~ point .

### Statement of Problem and Substantiation for Public Input

The existing code language is confusing by using a defined term in the code out of context. I believe the intent of the CMP was to say that the disconnecting means shall be located near the control point, but that isn't necessarily what the code is saying. Many in the enforcement community believe that this code article is simply stating that the disconnecting means has to be readily accessible. Changing the code language to the proposed language would give a definite answer to where the disconnecting means is permitted to be located.

### Submitter Information Verification

**Submitter Full Name:** Jesse Duvuvei

**Organization:** Middle Department Inspection Agency

**Street Address:**

**City:**

**State:**

**Zip:**

**Submittal Date:** Tue Jan 10 14:36:46 EST 2023

**Committee:** NEC-P15



## Public Input No. 3605-NFPA 70-2023 [ Section No. 517.73 ]

### 517.73 Rating of Supply Conductors and Overcurrent Protection.

#### (A) Branch Circuits.

The ampacity of supply branch-circuit conductors and the current rating of overcurrent protective devices shall not be less than 50 percent of the momentary rating or 100 percent of the long-time rating, whichever is greater.

#### (B) Feeders.

The ampacity of supply feeders and the current rating of overcurrent protective devices supplying two or more branch circuits supplying diagnostic imaging and treatment equipment shall not be less than the sum of the long-time rating for all equipment, plus 50 percent of the momentary demand rating of the largest unit, plus 25 percent of the momentary demand rating of the next largest unit, plus 10 percent of the momentary demand rating of each additional unit.

Informational Note No. 1: The minimum conductor size for branch and feeder circuits is also governed by voltage regulation requirements. For a specific installation, the manufacturer usually specifies minimum distribution transformer and conductor sizes, rating of disconnecting means, and overcurrent protection.

Informational Note No. 2: The ampacity of the branch-circuit conductors and the ratings of disconnecting means and overcurrent protection for diagnostic imaging and treatment equipment are usually designated by the manufacturer for the specific installation.

## Statement of Problem and Substantiation for Public Input

This particular PI is a placeholder. I am currently working on a study of these equipment loads, in conjunction with the University of California, ASHRAE, and the DOE. I hope to have data to provide us with better tools to analyze these factors by December, 2023. In addition, i think its important that we size the systems to serve the long-time rating of the equipment.

## Submitter Information Verification

**Submitter Full Name:** Walter Vernon

**Organization:** Mazzetti

**Street Address:**

**City:**

**State:**

**Zip:**

**Submittal Date:** Tue Sep 05 05:53:43 EDT 2023

**Committee:** NEC-P15



## Public Input No. 2751-NFPA 70-2023 [ Section No. 517.76 ]

### **517.76** Transformers and Capacitors.

Transformers and capacitors that are part of diagnostic imaging and treatment equipment shall not be required to comply with Articles 450 and 460, Parts I and II- ~~of Articles 450 and 460~~ .

Capacitors shall be mounted within enclosures of insulating material or grounded metal.

### Statement of Problem and Substantiation for Public Input

This Public Input is being submitted on behalf of the NEC Correlating Committee Usability Task Group in order to provide correlation throughout the document. The text is revised to to comply with the NEC Style Manual Section 4.1.4, regarding the use of Parts.

4.1.4 References to an Entire Article. References shall not be made to an entire article, except for the Article 100 or where referenced to provide the necessary context. References to specific parts within articles shall be permitted. References to all parts of an article shall not be permitted. The article number shall precede the part number.

The Usability Task Group members are: Derrick Atkins, David Hittinger, Richard Holub, Dean Hunter, Chad Kennedy and David Williams.

### Submitter Information Verification

**Submitter Full Name:** David Williams

**Organization:** Delta Charter Township

**Street Address:**

**City:**

**State:**

**Zip:**

**Submittal Date:** Thu Aug 24 19:57:20 EDT 2023

**Committee:** NEC-P15



## Public Input No. 2752-NFPA 70-2023 [ Section No. 517.78(C) ]

### (C) Non-Current-Carrying Metal Parts.

Non-current-carrying metal parts of diagnostic imaging and treatment equipment (e.g., controls, tables, transformer tanks, shielded cables) shall be connected to an equipment grounding conductor in accordance with ~~Part VII of Article~~ Article 250 , Part VII , as modified by 517.13(A) and (B).

### Statement of Problem and Substantiation for Public Input

This Public Input is being submitted on behalf of the NEC Correlating Committee Usability Task Group in order to provide correlation throughout the document. The text is revised to comply with the NEC Style Manual Section 4.1.4, regarding the use of Parts.

4.1.4 References to an Entire Article. References shall not be made to an entire article, except for the Article 100 or where referenced to provide the necessary context. References to specific parts within articles shall be permitted. References to all parts of an article shall not be permitted. The article number shall precede the part number.

The Usability Task Group members are: Derrick Atkins, David Hittinger, Richard Holub, Dean Hunter, Chad Kennedy and David Williams.

### Submitter Information Verification

**Submitter Full Name:** David Williams

**Organization:** Delta Charter Township

**Street Address:**

**City:**

**State:**

**Zip:**

**Submittal Date:** Thu Aug 24 19:58:04 EDT 2023

**Committee:** NEC-P15



## Public Input No. 4157-NFPA 70-2023 [ Section No. 517.80 ]

### 517.80 Patient Care Spaces.

Equivalent insulation and isolation to that required for the electrical distribution systems in patient care areas shall be provided for communications, signaling systems, data system circuits, fire alarm systems, and systems less than 120 volts, nominal.

Class 2 and Class 3 signaling and communications systems, Class 2 circuits that transmit power and data to a powered device, Class 4 fault managed power circuits, and power-limited fire alarm systems shall not be required to comply with the grounding requirements of 517.13, to comply with the mechanical protection requirements of 517.31(C)(3)(5), or to be enclosed in raceways, unless otherwise specified by Chapters 7 or 8.

Secondary circuits of transformer-powered communications or signaling systems shall not be required to be enclosed in raceways unless otherwise specified by Chapters 7 or 8.

[99:6.7.2.2.7]

Informational Note: See ANSI/NEMA C137.3-2017, *American National Standard for Lighting Systems — Minimum Requirements for Installation of Energy Efficient Power over Ethernet (PoE) Lighting Systems*, for information on installation of cables for PoE lighting systems.

### Statement of Problem and Substantiation for Public Input

Adding Class 4 to the list. Class 4 systems were added in the 2023 code and have equivalent or better than fire and life safety requirements as Class 2 circuits. An effort to analyze all the locations of Class 2 in the code to see if Class 4 was also appropriate in the application should have happened for the 2023 code and not doing it was an oversight.

### Submitter Information Verification

**Submitter Full Name:** Chad Jones

**Organization:** Cisco Systems

**Street Address:**

**City:**

**State:**

**Zip:**

**Submittal Date:** Wed Sep 06 19:02:44 EDT 2023

**Committee:** NEC-P15





## Public Input No. 977-NFPA 70-2023 [ Section No. 517.80 ]

### **517.80** Patient Care Spaces.

Equivalent insulation and isolation to that required for the electrical distribution systems in patient care areas shall be provided for communications, signaling systems, data system circuits, fire alarm systems, and systems less than 120 volts, nominal.

Class 2 and Class 3 signaling and communications systems, Class 2 circuits that transmit power and data to a powered device, and power-limited fire alarm systems shall not be required to comply with the grounding requirements of 517.13, ~~to~~ to comply with the mechanical protection requirements of 517.31(C)(3)(5), or to be enclosed in raceways, unless otherwise specified by Chapters 7 or 8 or except as noted for critical and life safety branch powered circuits.

Class 2 lighting circuit cabling fed from critical or life safety branch power shall comply with the mechanical protection requirements of this article. [99:6.7.5.2.2]

*Exception No. 1: Mechanical protection requirements shall not apply to wiring that does not exceed 6 feet in length and that terminates at a critical or life safety luminaire or an emergency lighting control device.*

*Exception No. 2: Mechanical protection requirements shall not apply to locked rooms or locked enclosures that are accessible only to qualified persons.*

*Informational Note: Locked rooms accessible only to qualified persons include locked telecommunications rooms, locked electrical equipment rooms, or other access-controlled areas.*

Secondary circuits of transformer-powered communications or signaling systems shall not be required to be enclosed in raceways unless otherwise specified by Chapters 7 or 8. [99:6.7.2.2.7]

Informational Note: See ANSI/NEMA C137.3-2017, *American National Standard for Lighting Systems — Minimum Requirements for Installation of Energy Efficient Power over Ethernet (PoE) Lighting Systems*, for information on installation of cables for PoE lighting systems.

## Statement of Problem and Substantiation for Public Input

PoE lighting circuits that have been identified to be served from life safety or critical branches have been deemed "essential to life safety" (NFPA 70-517.33) or "related to patient care" in Category 1 or Category 2 spaces primarily and others as "needed for effective facility operation" (NFPA 70-517.34). The removal of the requirement for mechanical protection of PoE lighting on these branches removes the additional reliability of power "against mechanical damage" (NFPA 70-517.31(C)(3)). Shock hazard protection of people from Class 2 or 3 cabling that is inherent to the definition of Class 2 or 3 cabling and compliance with NFPA 70-411 is not the reason for the requirement for mechanical protection of the critical or life safety circuits. The mechanical protection requirements are to protect the integrity of the circuits providing power to the equipment or lighting needed for life safety and patient care. Either the mechanical protection requirements should extend to PoE life safety and critical lighting circuits or it should be removed entirely for life safety or critical lighting circuits within NFPA 70-517.31(C)(3) for consistency.

The exceptions that have been incorporated into article 700 (where emergency cabling is required to be protected against physical damage) should be included in the mechanical protection requirement of 517 to allow for a constructable installation.

## Submitter Information Verification

**Submitter Full Name:** Andrew Reinke  
**Organization:** Specialized Engineering Solutions  
**Street Address:**  
**City:**  
**State:**  
**Zip:**  
**Submittal Date:** Wed Jun 07 17:37:34 EDT 2023  
**Committee:** NEC-P15



## Public Input No. 4056-NFPA 70-2023 [ Section No. 517.81 ]

### 517.81 Other-Than-Patient-Care Spaces.

In other-than-patient-care spaces, installations shall be in accordance with ~~other parts~~ Chapter 7 of this *Code*.

### Statement of Problem and Substantiation for Public Input

It is unclear if the intent is to direct the reader to chapter 7 (requires protection for low voltage wiring or 517.31 (requires mechanical protection for low voltage wiring). The proposed revision would clarify the intent.

### Related Public Inputs for This Document

<u>Related Input</u>	<u>Relationship</u>
<a href="#">Public Input No. 4057-NFPA 70-2023 [Section No. 517.81]</a>	
<a href="#">Public Input No. 4057-NFPA 70-2023 [Section No. 517.81]</a>	

### Submitter Information Verification

**Submitter Full Name:** Jamie Schnick  
**Organization:** OSHPD/HCAI  
**Street Address:**  
**City:**  
**State:**  
**Zip:**  
**Submittal Date:** Wed Sep 06 15:03:08 EDT 2023  
**Committee:** NEC-P15



## Public Input No. 4057-NFPA 70-2023 [ Section No. 517.81 ]

### 517.81 Other-Than-Patient-Care Spaces.

In other-than-patient-care spaces, installations shall be in accordance with ~~other parts~~ section 517.31 of this *Code*.

## Statement of Problem and Substantiation for Public Input

It is unclear if the intent is to direct the reader to chapter 7 (requires protection for low voltage wiring or 517.31 (requires mechanical protection for low voltage wiring). The proposed revision would clarify the intent.

## Related Public Inputs for This Document

<u>Related Input</u>	<u>Relationship</u>
<a href="#">Public Input No. 4056-NFPA 70-2023 [Section No. 517.81]</a>	same section with 1 of 2 choices here
<a href="#">Public Input No. 4056-NFPA 70-2023 [Section No. 517.81]</a>	

## Submitter Information Verification

**Submitter Full Name:** Jamie Schnick  
**Organization:** OSHPD/HCAI  
**Street Address:**  
**City:**  
**State:**  
**Zip:**  
**Submittal Date:** Wed Sep 06 15:07:28 EDT 2023  
**Committee:** NEC-P15



## Public Input No. 2516-NFPA 70-2023 [ Section No. 517.160(B) ]

### (B) Line Isolation Monitor.

#### (1) Characteristics.

In addition to the usual control and overcurrent protective devices, each isolated power system shall be provided with a listed continually operating line isolation monitor that indicates total hazard current. The monitor shall be designed such that a green signal lamp, conspicuously visible to persons in each area served by the isolated power system, remains lighted when the system is adequately isolated from ground. An adjacent red signal lamp and an audible warning signal (remote if desired) shall be energized when the total hazard current (consisting of possible resistive and capacitive leakage currents) from either isolated conductor to ground reaches a threshold value of 5 mA under nominal line voltage conditions. The line monitor shall not alarm for a fault hazard of less than 3.7 mA or for a total hazard current of less than 5 mA.

*Exception: A system shall be permitted to be designed to operate at a lower threshold value of total hazard current. A line isolation monitor for such a system shall be permitted to be approved, with the provision that the fault hazard current shall be permitted to be reduced but not to less than 35 percent of the corresponding threshold value of the total hazard current, and the monitor hazard current is to be correspondingly reduced to not more than 50 percent of the alarm threshold value of the total hazard current.*

#### (2) Impedance.

The line isolation monitor shall be designed to have sufficient internal impedance such that, when properly connected to the isolated system, the maximum internal current that can flow through the line isolation monitor, when any point of the isolated system is grounded, shall be 1 mA.

*Exception: The line isolation monitor shall be permitted to be of the low-impedance type such that the current through the line isolation monitor, when any point of the isolated system is grounded, will not exceed twice the alarm threshold value for a period not exceeding 5 milliseconds.*

Informational Note: Reduction of the monitor hazard current, provided this reduction results in an increased “not alarm” threshold value for the fault hazard current, will increase circuit capacity.

#### (3) Ammeter.

An ammeter calibrated in the total hazard current of the system (contribution of the fault hazard current plus monitor hazard current) shall be mounted in a plainly visible place on the line isolation monitor with the “alarm on” zone at approximately the center of the scale.

*Exception: The line isolation monitor shall be permitted to be a composite unit, with a sensing section cabled to a separate display panel section on which the alarm or test functions are located.*

*Informational Note: It is desirable to locate the ammeter so that it is conspicuously visible to persons in the anesthetizing location.*

#### (4) Testing.

**(a) Line Isolation Monitor (LIM) Tests.** Test per NFPA 99:6.3.3.3.2

**(b) LIM circuit Tests.** Test per NFPA 99:6.3.3.3.3

## Statement of Problem and Substantiation for Public Input

Testing requirements for Line Isolation Monitor and circuits missing.

Recommend adding the requirement to test per NFPA 99 standards.

### Submitter Information Verification

**Submitter Full Name:** Jamie Schnick  
**Organization:** OSHPD/HCAI  
**Affiliation:** Office of Hospitals Planning and Development/Department of Healthcare Access and Information – California  
**Street Address:**  
**City:**  
**State:**  
**Zip:**  
**Submittal Date:** Fri Aug 18 18:57:09 EDT 2023  
**Committee:** NEC-P15



## Public Input No. 999-NFPA 70-2023 [ Section No. 518.2(B) ]

### (B) Multiple Occupancies.

Where an assembly occupancy forms a portion of a building containing other occupancies, ~~Article 518 applies~~ this article applies only to that portion of the building considered an assembly occupancy. Occupancy of any room or space for assembly purposes by less than 100 persons in a building of other occupancy, and incidental to such other occupancy, shall be classified as part of the other occupancy.

### Statement of Problem and Substantiation for Public Input

Section 4.1.4 of the NEC(r) Style Manual prohibits reference to an entire article except Article 100 or where required for context. Revising list item B here to "this article" corrects this style manual problem. No proposal is offered for list item C as it is recommended to leave the language there as "it is required for context".

### Submitter Information Verification

**Submitter Full Name:** Richard Holub

**Organization:** The DuPont Company, Inc.

**Street Address:**

**City:**

**State:**

**Zip:**

**Submittal Date:** Thu Jun 08 15:19:42 EDT 2023

**Committee:** NEC-P15



## Public Input No. 4184-NFPA 70-2023 [ Section No. 518.3 ]

### 518.3 Temporary Wiring.

(A) General. In exhibition halls used for display booths, as in trade shows, the temporary wiring shall be permitted to be installed in accordance with Article 590. Flexible cables and cords approved for hard or extra-hard usage shall be permitted to be laid on floors where protected from contact by the general public.

(B) GFCI Protection. The ground-fault circuit-interrupter requirements of 590.6 shall not apply. All other ground-fault circuit-interrupter requirements of this *Code* shall apply. ~~Where ground-fault circuit-interrupter protection for personnel is cord-and-plug-connected to the branch circuit or to the feeder, the ground-fault circuit-interrupter protection shall be listed as portable ground-fault circuit-interrupter protection or provide a level of protection equivalent to a portable ground-fault circuit interrupter, whether assembled in the field or at the factory.~~

*Exception: Where conditions of supervision and maintenance ensure that only qualified persons will service the installation, flexible cords or cables identified in Table 400.4 for hard usage or extra-hard usage shall be permitted in cable trays used only for temporary wiring. All cords or cables shall be installed in a single layer. A permanent sign shall be attached to the cable tray at intervals not to exceed 7.5 m (25 ft) and read as follows:*

**CABLE TRAY FOR TEMPORARY WIRING ONLY**

### Statement of Problem and Substantiation for Public Input

Breaking up 518.3 into a list item format to facilitate understanding for Code users. In accordance with NFPA Style Manual section 3.5.1.2 additional subdivisions shall be used where multiple requirements can be broken into independent requirements.

### Submitter Information Verification

**Submitter Full Name:** Mike Holt

**Organization:** Mike Holt Enterprises Inc

**Street Address:**

**City:**

**State:**

**Zip:**

**Submittal Date:** Wed Sep 06 20:09:14 EDT 2023

**Committee:** NEC-P15





## Public Input No. 1272-NFPA 70-2023 [ Section No. 518.4(A) ]

### (A) General.

The wiring method shall ~~qualify as an equipment grounding conductor in accordance with 250.118 or shall contain an equipment grounding conductor sized in accordance with Table 250.122~~, and shall be any of the following:

- (1) Metal raceways
- (2) Flexible metal raceways
- (3) Nonmetallic raceways encased in not less than 50 mm (2 in.) of concrete
- (4) Type MI, Type MC, or Type AC cable

### Statement of Problem and Substantiation for Public Input

The two options given in this section are the only two options possible for any circuit. If the equipment requires connection to an equipment grounding conductor you must have an equipment grounding conductor. That may be the wiring method itself, or it may a wire-type EGC. This is true in every application, so this section is simply repeating requirements that are already found in Chapters 1-4. Furthermore, the guidance on sizing in this section is wrong. We do not use TABLE 250.122 for sizing, we use SECTION 250.122, which points to the table. There are plenty of instances, such as circuit for motors and tap conductors, where the required EGC is smaller than is specified in Table 250.122.

### Submitter Information Verification

**Submitter Full Name:** Ryan Jackson

**Organization:** Self-employed

**Street Address:**

**City:**

**State:**

**Zip:**

**Submittal Date:** Tue Jul 04 13:01:48 EDT 2023

**Committee:** NEC-P15



## Public Input No. 2398-NFPA 70-2023 [ Section No. 518.4(A) ]

### (A) General.

The wiring method ~~shall qualify as an equipment grounding conductor in accordance with 250.118 or shall contain an equipment grounding conductor sized in accordance with Table 250.122~~, ~~and shall be~~ shall be any of the following:

- (1) Metal raceways
- (2) Flexible metal raceways
- (3) Nonmetallic raceways encased in not less than 50 mm (2 in.) of concrete
- (4) Type MI, Type MC, or Type AC cable

### Statement of Problem and Substantiation for Public Input

There is no need to confuse Code users with this extra language about the equipment grounding conductor because it does not modify or supplement any of the requirements in Chapter 1 through 4. The only modification is limiting the installers to the list item wiring methods.

### Submitter Information Verification

**Submitter Full Name:** Mike Holt

**Organization:** Mike Holt Enterprises Inc

**Street Address:**

**City:**

**State:**

**Zip:**

**Submittal Date:** Wed Aug 16 16:38:22 EDT 2023

**Committee:** NEC-P15



## Public Input No. 642-NFPA 70-2023 [ Section No. 518.4(A) ]

### (A) General.

The ~~following~~ wiring method shall qualify as an equipment grounding conductor in accordance with ~~250.118~~ or shall contain an equipment grounding conductor sized in accordance with ~~Table 250.122~~ , and shall be any of the following methods shall be used :

- (1) Metal raceways
- (2) Flexible metal raceways
- (3) Nonmetallic raceways encased in not less than 50 mm (2 in.) of concrete
- (4) Type MI, Type MC, or Type AC cable

### Statement of Problem and Substantiation for Public Input

The language marked for deletion is superfluous. Every wiring method needs to be listed as an equipment grounding conductor or contain one if the circuit requires connection to an EGC. This editorial revision simplifies the text.

### Submitter Information Verification

**Submitter Full Name:** Ryan Jackson

**Organization:** Self-employed

**Street Address:**

**City:**

**State:**

**Zip:**

**Submission Date:** Mon Apr 17 12:09:23 EDT 2023

**Committee:** NEC-P15



## Public Input No. 2753-NFPA 70-2023 [ Section No. 518.4(B) ]

**(B)** Communications, Signaling Systems, Data Systems, Fire Alarm Systems, and Systems Less Than 120 Volts, Nominal.

Fixed wiring methods for specific installations shall be as follows:

- (1) Audio signal processing, amplification, and reproduction equipment — 640.9
- (2) Communications systems — ~~Part IV of Article 805, Part IV~~ and ~~Part VI of Article 840, Part VI~~
- (3) Class 2 and Class 3 remote control and signaling circuits — Article 725, Part III
- (4) Class 2 circuits that transmit power, data, or both to a powered device

Informational Note: See ANSI/NEMA C137.3-2017, *American National Standard for Lighting Systems — Minimum Requirements for Installation of Energy Efficient Power over Ethernet (PoE) Lighting Systems*, for information on installation of cables for PoE lighting systems. See ~~Part III of Article 760 - for~~ , Part III for information on fire alarm circuits.

### Statement of Problem and Substantiation for Public Input

This Public Input is being submitted on behalf of the NEC Correlating Committee Usability Task Group in order to provide correlation throughout the document. The text is revised to to comply with the NEC Style Manual Section 4.1.4, regarding the use of Parts.

4.1.4 References to an Entire Article. References shall not be made to an entire article, except for the Article 100 or where referenced to provide the necessary context. References to specific parts within articles shall be permitted. References to all parts of an article shall not be permitted. The article number shall precede the part number.

The Usability Task Group members are: Derrick Atkins, David Hittinger, Richard Holub, Dean Hunter, Chad Kennedy and David Williams.

### Submitter Information Verification

**Submitter Full Name:** David Williams

**Organization:** Delta Charter Township

**Street Address:**

**City:**

**State:**

**Zip:**

**Submittal Date:** Thu Aug 24 19:58:49 EDT 2023

**Committee:** NEC-P15



## Public Input No. 4158-NFPA 70-2023 [ Section No. 518.4(B) ]

**(B)** Communications, Signaling Systems, Data Systems, Fire Alarm Systems, and Systems Less Than 120 Volts, Nominal.

Fixed wiring methods for specific installations shall be as follows:

- (1) Audio signal processing, amplification, and reproduction equipment — 640.9
- (2) Communications systems — Part IV of Article 805 and Part VI of Article 840
- (3) Class 2 and Class 3 remote control and signaling circuits — Article 725, ~~Part III~~ Part II
- (4) Class 2 circuits that transmit power, data, or both to a powered device
- (5) Class 4 fault managed power circuits - Article 726, Part II

Informational Note: See ANSI/NEMA C137.3-2017, *American National Standard for Lighting Systems — Minimum Requirements for Installation of Energy Efficient Power over Ethernet (PoE) Lighting Systems*, for information on installation of cables for PoE lighting systems. See Part III of Article 760 for information on fire alarm circuits.

### Statement of Problem and Substantiation for Public Input

First, article 725 underwent big edits for 2023. Looks like this reference was not updated, fixing the pointer to Part II instead of Part III. Part III became Part II in 2023 when Class 1 circuits were moved to their own article.

Second, adding Class 4 to the list. Class 4 systems were added in the 2023 code and have equivalent or better than fire and life safety requirements as Class 2 circuits. An effort to analyze all the locations of Class 2 in the code to see if Class 4 was also appropriate in the application should have happened for the 2023 code and not doing it was an oversight.

### Submitter Information Verification

**Submitter Full Name:** Chad Jones

**Organization:** Cisco Systems

**Street Address:**

**City:**

**State:**

**Zip:**

**Submittal Date:** Wed Sep 06 19:05:29 EDT 2023

**Committee:** NEC-P15



## Public Input No. 4299-NFPA 70-2023 [ Section No. 518.4(B) ]

**(B) Communications, Signaling Systems, Data Systems, Fire Alarm Systems, and Systems Less Than 120 Volts, Nominal .**

Fixed wiring methods for specific installations shall be as follows:

- (1) Audio signal processing, amplification, and reproduction equipment — 640.9
- (2) Communications systems — Part IV of Article 805 and Part VI of Article 840
- (3) Class 2 and Class 3 remote control and signaling circuits — Article 725, Part III
- (4) Class 2 circuits that transmit power, data, or both to a powered device

Informational Note: See ANSI/NEMA C137.3-2017, *American National Standard for Lighting Systems — Minimum Requirements for Installation of Energy Efficient Power over Ethernet (PoE) Lighting Systems*, for information on installation of cables for PoE lighting systems. See Part III of Article 760 for information on fire alarm circuits.

### Statement of Problem and Substantiation for Public Input

This section includes ", and Systems Less Than 120 Volts, Nominal" in the title, yet the list of wiring methods do not include any specific to systems less than 120 volts nominal. Further, the title can cause confusion as it may appear that the wiring methods listed can be used with higher voltages than the referenced requirements actually allow. This phrase in the title appears to be vestigial, and came from 517, but serves no useful purpose here and should be deleted.

### Related Public Inputs for This Document

<u>Related Input</u>	<u>Relationship</u>
<a href="#">Public Input No. 4301-NFPA 70-2023 [Section No. 520.5(B)]</a>	
<a href="#">Public Input No. 4303-NFPA 70-2023 [Section No. 530.5(B)]</a>	

### Submitter Information Verification

**Submitter Full Name:** Jason Potterf  
**Organization:** Cisco  
**Affiliation:** ESTA  
**Street Address:**  
**City:**  
**State:**  
**Zip:**  
**Submission Date:** Thu Sep 07 10:17:42 EDT 2023  
**Committee:** NEC-P15



## Public Input No. 641-NFPA 70-2023 [ Section No. 518.4(B) ]

~~(B) Communications, Signaling Systems, Data Systems, Fire Alarm Systems, and Systems Less Than 120 Volts, Nominal.~~

~~Fixed wiring methods for specific installations shall be as follows:~~

- ~~(1) Audio signal processing, amplification, and reproduction equipment — 640.9~~
- ~~(2) Communications systems — Part IV of Article 805 and Part VI of Article 840~~
- ~~(3) Class 2 and Class 3 remote control and signaling circuits — Article 725, Part III~~
- ~~(4) Class 2 circuits that transmit power, data, or both to a powered device~~

~~Informational Note: See ANSI/NEMA C137.3-2017, *American National Standard for Lighting Systems — Minimum Requirements for Installation of Energy Efficient Power over Ethernet (PoE) Lighting Systems*, for information on installation of cables for PoE lighting systems. See Part III of Article 760 for information on fire alarm circuits.~~

### Statement of Problem and Substantiation for Public Input

This is already covered by 90.3. Furthermore, the title indicates that the section covers fire alarm and it doesn't, then the Informational Note refers to fire alarms despite them not being covered.

### Submitter Information Verification

**Submitter Full Name:** Ryan Jackson  
**Organization:** Self-employed  
**Street Address:**  
**City:**  
**State:**  
**Zip:**  
**Submission Date:** Mon Apr 17 12:07:14 EDT 2023  
**Committee:** NEC-P15



## Public Input No. 189-NFPA 70-2023 [ Section No. 518.5(A)(5) ]

### (5) Panelboard Orientation.

A panelboard installed in a listed commercial appliance outlet center designed for in-floor mounting shall be permitted to be ~~orientated~~ oriented in the face-up position, if such orientation is part of the listing, and 408.43 shall not apply.

### Statement of Problem and Substantiation for Public Input

While "orientated" and "oriented" have the same meaning, in common usage, "oriented" is preferred. The word orientated is a meaningless variation on the word. Orientated is not at all common in the United States. The NEC Style Manual is silent on these two words, but for clarity and commonly preferred usage, this word in this section should be changed to "oriented".

### Submitter Information Verification

**Submitter Full Name:** Steven Terry

**Organization:** Electronic Theatre Controls In

**Affiliation:** USITT

**Street Address:**

**City:**

**State:**

**Zip:**

**Submittal Date:** Tue Jan 17 20:36:20 EST 2023

**Committee:** NEC-P15





## Public Input No. 2075-NFPA 70-2023 [ Section No. 518.6 ]

### 518.6 Illumination.

Illumination shall be provided for all working spaces about fixed service equipment, switchboards, switchgear, enclosed panelboards, or motor control centers installed outdoors that serve assembly occupancies. Control by automatic means only shall not be permitted. Additional lighting outlets shall not be required where the workspace is illuminated by an adjacent light source.

### Statement of Problem and Substantiation for Public Input

The term 'panelboard' and 'enclosed panelboard' are defined terms. Adding the word 'enclosed panelboard' makes the text technically correct. Note: The term 'Enclosed Panelboard' was added to NEC Article 100 during the 2023 Code cycle.

### Submitter Information Verification

**Submitter Full Name:** Mike Holt

**Organization:** Mike Holt Enterprises Inc

**Street Address:**

**City:**

**State:**

**Zip:**

**Submittal Date:** Fri Aug 11 15:20:31 EDT 2023

**Committee:** NEC-P15



## Public Input No. 3747-NFPA 70-2023 [ New Section after 520.1 ]

### 520.2 Listing Requirements.

The following equipment shall be listed:

- (1) Fixed Stage Switchboards
- (2) Curtain Machines
- (3) Portable Stage Switchboards
- (4) Single-poleportable cable connectors
- (5) Arc lamps and associated ballasts
- (6) Portable power distribution units
- (7) Trunk cables, breakout assemblies and multicircuit enclosures

### Statement of Problem and Substantiation for Public Input

This Public Input is being submitted on behalf of the NEC Correlating Committee Usability Task Group in order to provide correlation throughout the document. A new section is added to comply with the NEC Style Manual Section 2.2.1 regarding Listing Requirements.

2.2.1 Parallel Numbering Required. Technical committees shall use the following section numbers for the same purposes within articles. This requirement shall not apply to Articles 90, 100, and 110. If the article does not contain listing or reconditioning requirements, the subdivisions shall not be included in the article.

Required Parallel Numbering Format

XXX.1 Scope.

XXX.2 Listing Requirements.

XXX.3 Reconditioned Equipment.

XXX.3(A) Permitted to be Installed.

XXX.3(B) Not Permitted to be Installed.

The Usability Task Group members are: Derrick Atkins, David Hittinger, Richard Holub, Dean Hunter, Chad Kennedy and David Williams.

### Submitter Information Verification

**Submitter Full Name:** David Williams

**Organization:** Delta Charter Township

**Street Address:**

**City:**

**State:**

**Zip:**

**Submittal Date:** Tue Sep 05 15:22:39 EDT 2023

**Committee:** NEC-P15



**Public Input No. 2907-NFPA 70-2023 [ Section No. 520.1 ]**

A large, empty rectangular box with a thin border, intended for public input or comments.

**520.1** Scope.

This article covers all buildings or that part of a building or structure, indoor or outdoor, designed or used for presentation, dramatic, musical, motion picture projection, or similar purposes and to specific audience seating areas within motion picture or television studios.

Informational Note No. 1: Definitions. Each of the following terms has a definition in Article 100 that is unique to its use in Article 520:

Adapter

Border light

Breakout assembly

Bundled

Connector strip

Deploy (Deployed)

Drop box

Footlight

Grouped

Multi-circuit cable outlet enclosure

Performance area

Pinout Configuration

Portable equipment

Portable power distribution unit

Portable stage switchboard

Proscenium

Special-purpose multi-circuit cable system

Stage equipment

Stage lighting hoist

Stand lamp

Strip light

Trunk cable

Two-fer

Informational Note No. 2: Definitions. Each of the following terms has a definition in Article 100 that appears in several articles but is important in its use in Article 520:

Solid-State Phase-Control Dimmer

Solid-State Sine Wave Dimmer

Stage Effect (Special Effect)

Stage Set

Stage Switchboard, Fixed (Fixed Stage Switchboard)

-

## Statement of Problem and Substantiation for Public Input

The change to locations of definitions in the 2023 Edition of the NEC was controversial for many people because it reduced usability. Even though other NFPA standards use this structure and was stated as a justification to the change in the 'NEC Style Manual' (some NFPA codes and standards include definitions within articles \*), many believe this relocation leads to confusion among users, especially for those articles that are specialty topics – i.e., the articles in Chapters 5 through 8. There are over 37 pages of definitions in Article 100 to search through.

Common language terms often have more specific meanings within an article. One only needs to look at the multiple definitions for 'Portable Equipment' to get a sense of this issue. Another example is 'Bundled' – specific to Article 520 – while 'Cable Bundle' is defined in Article 100 differently but not article specific. Without the proximate reference within Article 520, that distinction is not clear.

Under the current structure, important specialty definitions are lost in the sheer size of the Article 100 list. The usability of the NEC has been damaged, and users of specialty articles in Chapters 5 through 8 need help with this structure.

'Deploy (Deployed)' has been included to align with Public Input #2585 adding this definition and multiple Public Inputs including this term.

'Pinout Configuration' has been added to align with Public Input #2211 adding this definition and Public Input #2586 including this term.

To restore the usability of the NEC, what is needed is a way to clearly identify and point to specialty definitions in a standardized location within articles, while leaving the definitions themselves in Article 100. NFPA Link and the NEC Handbook add this information as Enhanced Content. Additionally, this "definition identification" model has proven its usability in other codes such as NFPA 1, NFPA 99, and NFPA 101. The NEC deserves no less.

\* Example: NFPA 101 – Section 6.1.2.1 'Assembly Occupancy' is one of several definitions in an Article; and in this instance it is duplicated from 3.3.205.2]. In fact, there are multiple definitions throughout NFPA 101.

## Submitter Information Verification

**Submitter Full Name:** Mitchell Hefter

**Organization:** Signify

**Street Address:**

**City:**

**State:**

**Zip:**

**Submission Date:** Sat Aug 26 15:58:29 EDT 2023

**Committee:** NEC-P15



## Public Input No. 2754-NFPA 70-2023 [ Section No. 520.5(B) ]

**(B)** Communications, Signaling Systems, Data Systems, Fire Alarm Systems, and Systems Less Than 120 Volts, Nominal.

Fixed wiring methods for specific installations shall be as follows:

- (1) Audio signal processing, amplification, and reproduction equipment — 640.9
- (2) Communications systems — ~~Article 800, Parts I and IV of Article 800, Part IV of Article 805, Part IV, and Part VI of Article 840, Part VI~~
- (3) Class 2 and Class 3 remote control and signaling circuits — ~~Part III of Article 725, Part III~~
- (4) Class 2 circuits that transmit power, data, or both to a powered device

Informational Note: See ANSI/NEMA C137.3-2017, *American National Standard for Lighting Systems — Minimum Requirements for Installation of Energy Efficient Power over Ethernet (PoE) Lighting Systems*, for information on installation of cables for PoE lighting systems. See Part III of Article 760 for information on fire alarm circuits.

### Statement of Problem and Substantiation for Public Input

This Public Input is being submitted on behalf of the NEC Correlating Committee Usability Task Group in order to provide correlation throughout the document. The text is revised to to comply with the NEC Style Manual Section 4.1.4, regarding the use of Parts.

4.1.4 References to an Entire Article. References shall not be made to an entire article, except for the Article 100 or where referenced to provide the necessary context. References to specific parts within articles shall be permitted. References to all parts of an article shall not be permitted. The article number shall precede the part number.

The Usability Task Group members are: Derrick Atkins, David Hittinger, Richard Holub, Dean Hunter, Chad Kennedy and David Williams.

### Submitter Information Verification

**Submitter Full Name:** David Williams

**Organization:** Delta Charter Township

**Street Address:**

**City:**

**State:**

**Zip:**

**Submittal Date:** Thu Aug 24 20:01:31 EDT 2023

**Committee:** NEC-P15



## Public Input No. 4170-NFPA 70-2023 [ Section No. 520.5(B) ]

**(B)** Communications, Signaling Systems, Data Systems, Fire Alarm Systems, and Systems Less Than 120 Volts, Nominal.

Fixed wiring methods for specific installations shall be as follows:

- (1) Audio signal processing, amplification, and reproduction equipment — 640.9
- (2) Communications systems — Parts I and IV of Article 800, Part IV of Article 805, and Part VI of Article 840
- (3) Class 2 and Class 3 remote control and signaling circuits — ~~Part III of~~ Part II of Article 725
- (4) Class 2 circuits that transmit power, data, or both to a powered device
- (5) Class 4 fault managed power circuits - Part II of Article 726

Informational Note: See ANSI/NEMA C137.3-2017, *American National Standard for Lighting Systems — Minimum Requirements for Installation of Energy Efficient Power over Ethernet (PoE) Lighting Systems*, for information on installation of cables for PoE lighting systems. See Part III of Article 760 for information on fire alarm circuits.

### Statement of Problem and Substantiation for Public Input

First, article 725 underwent big edits for 2023. Looks like this reference was not updated, fixing the pointer to Part II instead of Part III. Part III became Part II in 2023 when Class 1 circuits were moved to their own article.

Second, adding Class 4 to the list. Class 4 systems were added in the 2023 code and have equivalent or better than fire and life safety requirements as Class 2 circuits. An effort to analyze all the locations of Class 2 in the code to see if Class 4 was also appropriate in the application should have happened for the 2023 code and not doing it was an oversight.

### Submitter Information Verification

**Submitter Full Name:** Chad Jones

**Organization:** Cisco Systems

**Street Address:**

**City:**

**State:**

**Zip:**

**Submission Date:** Wed Sep 06 19:20:30 EDT 2023

**Committee:** NEC-P15





## Public Input No. 4301-NFPA 70-2023 [ Section No. 520.5(B) ]

**(B) Communications, Signaling Systems, Data Systems, Fire Alarm Systems, and Systems Less Than 120 Volts, Nominal .**

Fixed wiring methods for specific installations shall be as follows:

- (1) Audio signal processing, amplification, and reproduction equipment — 640.9
- (2) Communications systems — Parts I and IV of Article 800, Part IV of Article 805, and Part VI of Article 840
- (3) Class 2 and Class 3 remote control and signaling circuits — Part III of Article 725
- (4) Class 2 circuits that transmit power, data, or both to a powered device

Informational Note: See ANSI/NEMA C137.3-2017, *American National Standard for Lighting Systems — Minimum Requirements for Installation of Energy Efficient Power over Ethernet (PoE) Lighting Systems*, for information on installation of cables for PoE lighting systems. See Part III of Article 760 for information on fire alarm circuits.

### Statement of Problem and Substantiation for Public Input

This section includes ", and Systems Less Than 120 Volts, Nominal" in the title, yet the list of wiring methods do not include any specific to systems less than 120 volts nominal. Further, the title can cause confusion as it may appear that the wiring methods listed can be used with higher voltages than the referenced requirements actually allow. This phrase in the title appears to be vestigial, and came from 517, but serves no useful purpose here and should be deleted.

### Related Public Inputs for This Document

<u>Related Input</u>	<u>Relationship</u>
<a href="#">Public Input No. 4299-NFPA 70-2023 [Section No. 518.4(B)]</a>	Same language that needs to be removed
<a href="#">Public Input No. 4303-NFPA 70-2023 [Section No. 530.5(B)]</a>	

### Submitter Information Verification

**Submitter Full Name:** Jason Potterf  
**Organization:** Cisco  
**Affiliation:** ESTA  
**Street Address:**  
**City:**  
**State:**  
**Zip:**  
**Submission Date:** Thu Sep 07 10:21:20 EDT 2023  
**Committee:** NEC-P15



## Public Input No. 1000-NFPA 70-2023 [ Section No. 520.5(C) ]

### (C) Portable Equipment.

The wiring for portable switchboards, stage set lighting, stage effects, and other wiring not fixed as to location shall be permitted with approved flexible cords and cables as provided elsewhere in ~~Article 520~~ this article . Fastening such cables and cords by uninsulated staples or nailing shall not be permitted.

### Statement of Problem and Substantiation for Public Input

Section 4.1.4 of the NEC(r) Style Manual prohibits referencing an entire article except Article 100 or where required for context. Thus, it is recommended to revise the language here as shown for style manual compliance, without changing the meaning of the text.

### Submitter Information Verification

**Submitter Full Name:** Richard Holub

**Organization:** The DuPont Company, Inc.

**Street Address:**

**City:**

**State:**

**Zip:**

**Submittal Date:** Thu Jun 08 15:24:34 EDT 2023

**Committee:** NEC-P15



## Public Input No. 1034-NFPA 70-2023 [ Section No. 520.5(C) ]

### (C) Portable Equipment.

The wiring for portable switchboards, stage set lighting, stage effects, and other wiring not fixed as to location shall be permitted with approved flexible cords and cables as provided elsewhere in ~~Article 520~~ this article . Fastening such cables and cords by uninsulated staples or nailing shall not be permitted.

### Statement of Problem and Substantiation for Public Input

Section 4.1.4 of the NEC(r) Style Manual prohibits referencing an entire article except Article 100 or where required for context. As such, it is suggested that changing the language here to "this article" would correct this Style Manual problem without altering the meaning of the current text.

### Submitter Information Verification

**Submitter Full Name:** Richard Holub

**Organization:** The DuPont Company, Inc.

**Street Address:**

**City:**

**State:**

**Zip:**

**Submittal Date:** Mon Jun 12 13:53:16 EDT 2023

**Committee:** NEC-P15



## Public Input No. 2212-NFPA 70-2023 [ Section No. 520.10 ]

### 520.10 Portable Equipment Used- Deployed Outdoors.

Portable stage and studio lighting equipment and portable power distribution equipment not identified for outdoor use shall be permitted ~~for temporary use~~ to be deployed outdoors if the equipment is supervised by qualified personnel while energized and ~~barriered~~ from the general public.

Informational Note No. 1 : See ANSI/ESTA E1.58-2017, *Electrical Safety Standard for Portable Stage and Studio Equipment Used Outdoors*, for information on the use of portable stage and studio lighting equipment outdoors.

Informational Note No. 2: See ANSI/ESTA E1.19-2021, *Recommended Practice for the use of Class A Ground-Fault Circuit Interrupters (GFCIs) intended for personnel protection in the Entertainment Industry*, for guidance on the use of GFCIs in wet locations.

## Statement of Problem and Substantiation for Public Input

Using the word “temporary” in this section may be improperly interpreted as being covered by Article 590 – Temporary Installations. Portable equipment is not permanently installed in venues covered by the “Entertainment Industry” Articles 518, 520, 525, and 530. Use of the words “deploy” / “deployed” is more descriptive of the portable equipment use and prevents misinterpretation.

This PI was created by an unofficial task group consisting of:

Steve Terry CMP15  
 Wendy Russell CMP15  
 Mitch Hefter CMP15  
 Hans Lau IATSE Local 728  
 Alan Rowe CMP15  
 Mike Skinner CMP15  
 Jason Potterf CMP18  
 Bill Ellis CMP18  
 Duane Wilson CMP15

## Related Public Inputs for This Document

<u>Related Input</u>	<u>Relationship</u>
<a href="#">Public Input No. 2585-NFPA 70-2023 [New Definition after Definition: Dental Office.]</a>	Definition of Deploy (Deployed)
<a href="#">Public Input No. 2585-NFPA 70-2023 [New Definition after Definition: Dental Office.]</a>	

## Submitter Information Verification

**Submitter Full Name:** Steven Terry  
**Organization:** Electronic Theatre Controls In  
**Affiliation:** US Institute for Theatre Technology  
**Street Address:**  
**City:**  
**State:**

**Zip:**

**Submittal Date:** Tue Aug 15 09:07:35 EDT 2023

**Committee:** NEC-P15



## Public Input No. 1040-NFPA 70-2023 [ Section No. 520.41(B) ]

### (B) Circuits Rated Greater Than 20 Amperes.

Where only heavy-duty lampholders are used, such circuits shall be permitted to comply with Article 210- ~~for circuits supplying heavy-duty lampholders. 21(A), 210.23(C), or 210.23(D) as applicable.~~

### Statement of Problem and Substantiation for Public Input

Section 4.1.4 of the NEC(r) Style Manual prohibits referencing an entire article, except Article 100 or where required for context and as such, it is recommended to reference the individual applicable sections to improve usability of these links.

### Submitter Information Verification

**Submitter Full Name:** Richard Holub

**Organization:** The DuPont Company, Inc.

**Street Address:**

**City:**

**State:**

**Zip:**

**Submittal Date:** Mon Jun 12 14:28:43 EDT 2023

**Committee:** NEC-P15



## Public Input No. 1143-NFPA 70-2023 [ Section No. 520.45 ]

### **520.45** Receptacles.

Receptacles for electrical equipment on stages shall be rated in amperes. ~~Conductors~~  
~~Conductor ampacity for conductors~~ supplying receptacles shall be in accordance with ~~Articles~~  
~~310 and 400~~ the associated other articles of this code .

### Statement of Problem and Substantiation for Public Input

Section 4.1.4 of the NEC® Style Manual prohibits reference to an entire article, with the exception of Article 100 or where required for context. The second sentence could be eliminated here as the other articles apply in accordance with 90.3, or this sentence could be modified as shown in this PI to avoid this style manual violation while making reference to the appropriate rules.

### Submitter Information Verification

**Submitter Full Name:** Richard Holub

**Organization:** The DuPont Company, Inc.

**Street Address:**

**City:**

**State:**

**Zip:**

**Submittal Date:** Tue Jun 20 11:06:36 EDT 2023

**Committee:** NEC-P15



## Public Input No. 1144-NFPA 70-2023 [ Section No. 520.50(D) ]

(D) Enclosure.

Panel construction shall be in accordance with Article 408, Parts I, II, and IV .

### Statement of Problem and Substantiation for Public Input

Section 4.1.4 of the NEC® Style Manual prohibits reference to an entire article with the exception of Article 100 or where required for context. As such, it is suggested that this reference be modified to refer to the specific parts of the article which apply, in this case leaving out the reference to Part III of the article which is specific to panelboards. As this section is specific to switchboards, the remaining parts of this article seem to be the correct parts to reference.

### Submitter Information Verification

**Submitter Full Name:** Richard Holub

**Organization:** The DuPont Company, Inc.

**Street Address:**

**City:**

**State:**

**Zip:**

**Submittal Date:** Tue Jun 20 11:11:23 EDT 2023

**Committee:** NEC-P15





## Public Input No. 2586-NFPA 70-2023 [ Section No. 520.68(D) ]

### (D) Special-Purpose Multicircuit Cable Systems.

Special-purpose multicircuit cable systems shall comply with the following requirements:

- (1) Branch circuits shall be rated at not more than 20 amperes and not more than 150 volts to ground.
- (2) Trunk cable types shall be extra-hard usage (hard service) or hard usage (junior hard service).
- (3) The ampacity of trunk cables shall be determined in accordance with Table 520.44(C) (2)(1).
- (4) Trunk cables, breakout assemblies, and multicircuit enclosures shall be listed.
- (5) Section 406.4(F) shall not apply to multicircuit, multipole plugs or receptacles that are part of a special-purpose multicircuit cable system.
- (6) ~~All~~ When deployed, multicircuit, multipole connectors shall be clearly marked with the to uniquely identify the pinout configuration type of the connector and the voltage of the branch circuits serviced by the connector.
- (7) ~~Installation and operation shall be performed by qualified persons.~~

(7) Qualified persons shall deploy and operate special-purpose multicircuit cable systems.

Informational Note: See ESTA E1.80-202x for information on pinout configuration types.

## Statement of Problem and Substantiation for Public Input

There are multiple multicircuit connectors in wide use in Article 520 occupancies. Many different pinout configurations are used for audio, lighting, effects equipment, video walls, and other systems. There is currently no requirement to require clear identification of the different configurations. Adding this marking requirement in combination with the existing qualified persons requirement provides a clear understanding of the pinout configuration in use. The Entertainment Services and Technology Association (ESTA) Technical Standards Program (ANSI E1) is developing a standard for such marking.

This PI was created by an unofficial task group consisting of:

Steve Terry CMP15  
 Wendy Russell CMP15  
 Mitch Hefter CMP15  
 Hans Lau IATSE Local 728  
 Alan Rowe CMP15  
 Mike Skinner CMP15  
 Jason Potterf CMP18  
 Bill Ellis CMP18  
 Duane Wilson CMP15

## Related Public Inputs for This Document

<u>Related Input</u>	<u>Relationship</u>
<u>Public Input No. 2585-NFPA 70-2023 [New Definition after Definition: Dental Office.]</u>	New Definition of Deploy (Deployed)
<u>Public Input No. 2211-NFPA 70-2023 [New Definition after Definition: Pier, Floating. (Floating ...)]</u>	New Definition of Pinout Configuration

[Public Input No. 2211-NFPA 70-2023 \[New Definition after Definition: Pier, Floating\\_. \(Floating ...\]](#)

[Public Input No. 2585-NFPA 70-2023 \[New Definition after Definition: Dental Office.\]](#)

## Submitter Information Verification

**Submitter Full Name:** Steven Terry

**Organization:** Electronic Theatre Controls In

**Affiliation:** US Institute for Theatre Technology

**Street Address:**

**City:**

**State:**

**Zip:**

**Submittal Date:** Wed Aug 23 11:42:18 EDT 2023

**Committee:** NEC-P15



## Public Input No. 2908-NFPA 70-2023 [ Section No. 522.1 ]

### 522.1 Scope.

This article covers the installation of control circuit power sources and control circuit conductors for electrical equipment, including associated control wiring in or on all structures, that are an integral part of a permanent amusement attraction.

Informational Note: Definitions. Each of the following terms has a definition in Article 100 that is unique to its use in Article 522:

Entertainment device

Permanent amusement attraction

Ride device

-

## Statement of Problem and Substantiation for Public Input

The change to locations of definitions in the 2023 Edition of the NEC was controversial for many people because it reduced usability. Even though other NFPA standards use this structure and was stated as a justification to the change in the 'NEC Style Manual' (some NFPA codes and standards include definitions within articles \*), many believe this relocation leads to confusion among users, especially for those articles that are specialty topics – i.e., the articles in Chapters 5 through 8. There are over 37 pages of definitions in Article 100 to search through.

Common language terms often have more specific meanings within an article. One only needs to look at the multiple definitions for 'Portable Equipment' to get a sense of this issue. Another example is 'Bundled' – specific to Article 520 – while 'Cable Bundle' is defined in Article 100 differently but not article specific. 'Entertainment Device' is very specific to this article, but without a proximate reference within Article 522, it is a term that could be improperly interpreted without knowing it is specifically defined.

Under the current structure, important specialty definitions are lost in the sheer size of the Article 100 list. The usability of the NEC has been damaged, and users of specialty articles in Chapters 5 through 8 need help with this structure.

To restore the usability of the NEC, what is needed is a way to clearly identify and point to specialty definitions in a standardized location within articles, while leaving the definitions themselves in Article 100. NFPA Link and the NEC Handbook add this information as Enhanced Content. Additionally, this "definition identification" model has proven its usability in other codes such as NFPA 1, NFPA 99, and NFPA 101. The NEC deserves no less.

\* Example: NFPA 101 – Section 6.1.2.1 'Assembly Occupancy' is one of several definitions in an Article; and in this instance it is duplicated from 3.3.205.2]. In fact, there are multiple definitions throughout NFPA 101.

## Submitter Information Verification

**Submitter Full Name:** Mitchell Hefter

**Organization:** Signify

**Street Address:**

**City:**

**State:**

**Zip:**

**Submittal Date:** Sat Aug 26 16:01:05 EDT 2023

**Committee:** NEC-P15



## Public Input No. 2755-NFPA 70-2023 [ Section No. 522.10 ]

### **522.10** Power Sources for Control Circuits.

#### **(A)** Power-Limited Control Circuits.

Power-limited control circuits shall be supplied from a source that has a rated output of not more than 30 volts and 1000 volt-amperes.

##### **(1)** Control Transformers.

Transformers used to supply power-limited control circuits shall comply with the applicable sections within Article 450, Parts I and II of ~~Article 450~~.

##### **(2)** Other Power-Limited Control Power Sources.

Power-limited control power sources, other than transformers, shall be protected by overcurrent devices rated at not more than 167 percent of the volt-ampere rating of the source divided by the rated voltage. The fusible overcurrent devices shall not be interchangeable with fusible overcurrent devices of higher ratings. The overcurrent device shall be permitted to be an integral part of the power source.

To comply with the 1000 volt-ampere limitation of 522.10(A), the maximum output of power sources, other than transformers, shall be limited to 2500 volt-amperes, and the product of the maximum current and maximum voltage shall not exceed 10,000 volt-amperes. These ratings shall be determined with any overcurrent-protective device bypassed.

#### **(B)** Non-Power-Limited Control Circuits.

Non-power-limited control circuits shall not exceed 300 volts. The power output of the source shall not be required to be limited.

##### **(1)** Control Transformers.

Transformers used to supply non-power-limited control circuits shall comply with the applicable sections within Article 450, Parts I and II of ~~Article 450~~.

##### **(2)** Other Non-Power-Limited Control Power Sources.

Non-power-limited control power sources, other than transformers, shall be protected by overcurrent devices rated at not more than 125 percent of the volt-ampere rating of the source divided by the rated voltage. The fusible overcurrent devices shall not be interchangeable with fusible overcurrent devices of higher ratings. The overcurrent device shall be permitted to be an integral part of the power source.

## Statement of Problem and Substantiation for Public Input

This Public Input is being submitted on behalf of the NEC Correlating Committee Usability Task Group in order to provide correlation throughout the document. The text is revised to to comply with the NEC Style Manual Section 4.1.4, regarding the use of Parts.

4.1.4 References to an Entire Article. References shall not be made to an entire article, except for the Article 100 or where referenced to provide the necessary context. References to specific parts within articles shall be permitted. References to all parts of an article shall not be permitted. The article number shall precede the part number.

The Usability Task Group members are: Derrick Atkins, David Hittinger, Richard Holub, Dean Hunter, Chad Kennedy and David Williams.

## Submitter Information Verification

**Submitter Full Name:** David Williams

**Organization:** Delta Charter Township  
**Street Address:**  
**City:**  
**State:**  
**Zip:**  
**Submittal Date:** Thu Aug 24 20:03:47 EDT 2023  
**Committee:** NEC-P15



## Public Input No. 2063-NFPA 70-2023 [ Article 525 ]

### ~~Article 525 – Carnivals, Circuses, Fairs, and Similar Events~~

#### ~~Part I. – General~~

##### ~~525.1 – Scope.~~

~~This article covers the installation of portable wiring and equipment for carnivals, circuses, fairs, and similar functions, including wiring in or on all structures.~~

##### ~~525.3 – Other Articles.~~

###### ~~(A) – Portable Wiring and Equipment.~~

~~Wherever the requirements of other articles of this Code and Article 525 differ, the requirements of Article 525 shall apply to the portable wiring and equipment.~~

###### ~~(B) – Attractions Utilizing Pools, Fountains, and Similar Installations with Contained Volumes of Water.~~

~~This equipment shall be installed to comply with the applicable requirements of Parts I, II, III, and V of Article 680.~~

##### ~~525.5 – Overhead Conductor Clearances.~~

###### ~~(A) – Vertical Clearances.~~

~~Conductors shall have a vertical clearance to ground in accordance with 225.18. These clearances shall apply only to wiring installed outside of tents and concessions.~~

###### ~~(B) – Clearance to Portable Structures.~~

###### ~~(1) – 600 Volts (or Less).~~

~~Portable structures shall be maintained not less than 4.5 m (15 ft) in any direction from overhead conductors operating at 600 volts or less, except for the conductors supplying the portable structure. Portable structures included in 525.3(B) shall comply with Table 680.9(A).~~

###### ~~(2) – Over 600 Volts.~~

~~Portable structures shall not be located under or within a space that is located 4.5 m (15 ft) horizontally and extending vertically to grade of conductors operating in excess of 600 volts.~~

##### ~~525.6 – Protection of Electrical Equipment.~~

~~Electrical equipment and wiring methods in or on portable structures shall be provided with mechanical protection where such equipment or wiring methods are subject to physical damage.~~

#### ~~Part II. – Power Sources~~

##### ~~525.10 – Services.~~

~~Services shall comply with 525.10(A) and (B).~~

###### ~~(A) – Guarding.~~

~~Service equipment shall not be installed in a location that is accessible to unqualified persons, unless the equipment is lockable.~~

###### ~~(B) – Mounting and Location.~~

~~Service equipment shall be securely fastened to a solid backing and be installed so as to be protected from the weather, unless of weatherproof construction.~~

**525.11**— Multiple Sources of Supply.

Where multiple services or separately derived systems, or both, supply portable structures, the equipment grounding conductors of all the sources of supply that serve such structures separated by less than 3.7 m (12 ft) shall be bonded together at the portable structures. The bonding conductor shall be copper and sized in accordance with Table 250.122 based on the largest overcurrent device supplying the portable structures, but not smaller than 6 AWG.

**Part III.**— Wiring Methods**525.20**— Wiring Methods.**(A)**— Type.

Where flexible cords or cables are used, they shall be listed for extra-hard usage. Where flexible cords or cables are used and are not subject to physical damage, they shall be permitted to be listed for hard usage. Where used outdoors, flexible cords and cables shall also be listed for wet locations and shall be sunlight resistant. Extra-hard usage flexible cords or cables shall be permitted for use as permanent wiring on portable amusement rides and attractions where not subject to physical damage.

**(B)**— Single-Conductor.

Single-conductor cable shall be permitted only in sizes 2 AWG or larger.

**(C)**— Open Conductors.

Open conductors shall be prohibited except as part of a listed assembly or festoon lighting installed in accordance with Article 225.

**(D)**— Splices.

Flexible cords or cables shall be continuous without splice or tap between boxes or fittings.

**(E)**— Cord Connectors.

Cord connectors shall not be laid on the ground unless listed for wet locations. Connectors and cable connections shall not be placed in audience traffic paths or within areas accessible to the public unless guarded.

**(F)**— Support.

Wiring for an amusement ride, attraction, tent, or similar structure shall not be supported by any other ride or structure unless specifically designed for the purpose.

**(G)**— Protection.

Flexible cords or cables accessible to the public shall be arranged to minimize the tripping hazard and shall be permitted to be covered with nonconductive matting secured to the walkway surface or protected with another approved cable protection method, provided that the matting or other protection method does not constitute a greater tripping hazard than the uncovered cables. Burying cables shall be permitted. The requirements of 300.5 shall not apply.

**(H)**— Boxes and Fittings.

A box or fitting shall be installed at each connection point, outlet, switchpoint, or junction point.

**525.21**— Rides, Tents, and Concessions.**(A)**— Disconnecting Means.

A means to disconnect each portable structure from all ungrounded conductors shall be provided. The disconnecting means shall be located within sight of and within 1.8 m (6 ft) of the operator's station. The disconnecting means shall be readily accessible to the operator, including when the ride is in operation. If accessible to unqualified persons, the disconnecting means shall be lockable. A shunt trip device that opens the fused disconnect or circuit breaker if a switch located in the ride operator's console is closed shall be a permissible method of opening the circuit.



~~(B) Portable Wiring Inside Tents and Concessions.~~

~~Electrical wiring for lighting, where installed inside of tents and concessions, shall be securely installed and, where subject to physical damage, shall be provided with mechanical protection. All lamps for general illumination shall be protected from accidental breakage by a luminaire or lampholder with a guard.~~

~~525.22 Portable Distribution or Termination Boxes.~~

~~Portable distribution or termination boxes shall comply with 525.22(A) through (D).~~

~~(A) Construction.~~

~~Boxes shall be designed so that no live parts are exposed except where necessary for examination, adjustment, servicing, or maintenance by qualified persons. If installed outdoors, the box shall be of weatherproof construction and mounted so that the bottom of the enclosure is not less than 150 mm (6 in.) above the ground.~~

~~(B) Busbars and Terminals.~~

~~Busbars shall have an ampere rating not less than the overcurrent device supplying the feeder supplying the box. Where conductors terminate directly on busbars, busbar connectors shall be provided.~~

~~(C) Receptacles and Overcurrent Protection.~~

~~Receptacles shall have overcurrent protection installed within the box. The overcurrent protection shall not exceed the ampere rating of the receptacle, except as permitted in Article 430 for motor loads.~~

~~(D) Single-Pole Connectors.~~

~~Where single-pole connectors are used, they shall comply with 530.10.~~

~~525.23 Ground-Fault Circuit-Interrupter (GFCI) Protection.~~

~~(A) Where GFCI Protection Is Required.~~

~~In addition to the requirements of 210.8(B), GFCI protection for personnel shall be provided for the following:~~

- ~~(1) All 125-volt, single-phase, 15- and 20-ampere non-locking-type receptacles used for disassembly and reassembly or readily accessible to the general public~~
- ~~(2) Equipment that is readily accessible to the general public and supplied from a 125-volt, single-phase, 15- or 20-ampere branch circuit~~

~~The GFCI shall be permitted to be an integral part of the attachment plug or located in the power-supply cord within 300 mm (12 in.) of the attachment plug. Listed cord sets incorporating GFCI for personnel shall be permitted.~~

~~(B) Where GFCI Protection Is Not Required.~~

~~Receptacles that are not accessible from grade level and that only facilitate quick disconnecting and reconnecting of electrical equipment shall not be required to be provided with GFCI protection. These receptacles shall be of the locking type.~~

~~(C) Where GFCI Protection Is Not Permitted.~~

~~Egress lighting shall not be protected by a GFCI.~~

~~(D) Receptacles Supplied by Portable Cords.~~

~~Where GFCI protection is provided through the use of GFCI receptacles, and the branch circuits supplying receptacles use flexible cord, the GFCI protection shall be listed, labeled, and identified for portable use.~~

~~Part IV. Equipment Grounding and Bonding~~

**525.30**– Equipment Bonding.

The following equipment connected to the same source shall be bonded:

- (1) ~~Metal raceways and metal-sheathed cable~~
- (2) ~~Metal enclosures of electrical equipment~~
- (3) ~~Metal frames and metal parts of portable structures, trailers, trucks, or other equipment that contain or support electrical equipment~~

Where the metal frames or parts of the equipment in 525.30 (1), (2), or (3) are likely to become energized in the event of a fault, the equipment grounding conductor of the supply circuit shall be permitted to serve as the bonding means.

**525.31**– Equipment Grounding.

The equipment grounding conductor shall be connected to the system grounded conductor at the service disconnecting means or, in the case of a separately derived system such as a generator, at the generator or first disconnecting means supplied by the generator.

**525.32**– Equipment Grounding Conductor Continuity Assurance.

The continuity of the equipment grounding conductors shall be verified each time that portable electrical equipment is connected.

See attached proposed text for Article 525.

## Additional Proposed Changes

<u>File Name</u>	<u>Description</u>	<u>Approved</u>
Proposed_Article_525.docx	Proposed Article 525 changes for the 2026 NEC.	

## Statement of Problem and Substantiation for Public Input

This public input is being submitted on behalf of the Minnesota Department of Labor and Industry. Currently, the Department's inspection staff includes 14-office/field staff, 12-state field inspectors, 2-virtual inspectors and 50 plus contract electrical inspectors that complete over 170,000 electrical inspections annually.

The proposed changes will update the broad requirements in Article 525 to make them more focused on the types of installations that are found at a carnival and fair. Over the last few decades, our department has done thousands of inspections on carnival rides, festivals, and concession stand trailers. The proposed changes are technical issues, and conflicts that we have found over the last couple of code cycles.

First, the scope. The first issue was addressing the permanent wiring within the portable structure. We have run into issues in the past, where concession trailers, built in other parts of the country, do not have proper wiring methods, basically, THWN run through the walls of trailers with no electrical boxes has been commonplace. The new language would address the permanent wiring within a portable trailer or structure used at a fair, carnival, or festival.

525.11(A). Recognizes the vehicle mounted generator as another source of power at these events. Our experience has been that a circus set up, in a large tent or building, generally, runs off permanent power or distribution; however, when inspecting carnivals and fairs, the distribution mainly comes from a large vehicle mounted generators.

525.11(B) Recognizes portable generators that are often used at festivals and/or farmers markets. By adding this language, it will require the smaller generators to be used in compliance with 545.20.

525.21 adds language to separate the requirements for disconnect means being located within 6' of the operator at a ride versus a concession trailer. In addition, added language for slides and inflatables

at the end of the section to clarify that those disconnect requirements could comply with part (B).

525.21(B) the disconnecting means can be located within 6' from the outside of the concession trailer of tent - if other requirements are met. Also, added an exception for a single portable cord cap/ extension cord (with GFCI protection) to be routed to a booth or tent and be used as the disconnecting means. Many times, a small festival booth may only need a receptacle for a phone charger and a box fan.

525.23 Language was reorganized to only cover the 125-volt, 15, and 20-amp receptacles. There is no substantiation to warrant an expansion of GFCI protection to 250-volt receptacles. There are many existing trailers that we inspect annually with existing panelboards that won't allow for a 250-volt GFCI breaker to be installed, plus the fact that after all these years, and after thousands of inspections, our agency has not heard of any portable concession trailer fatalities.

An exception was added to address the inverter generators that don't provide GFCI protection. These units have a non-conductive case, and only have one 125-volt 15 or 20-amp receptacle. These portable generators are generally not bonded and because of the exception in 545.20, they are not required to have GFCI protection. We see many of these small 15 KW and less generators being used at these events, and they have no GFCI protection. In our opinion, this conflicts with what article 525 requires.

525.30 Language was added to require a minimum #12 AWG copper equipment grounding conductor due to the harsh weather and severe physical damage in which these cords are exposed.

525.31 Requires that a separately derived system to be bonded. The new exception points to the exception in 445. 20 that doesn't require bonding for the inverter generator.

## Submitter Information Verification

**Submitter Full Name:** Dean Hunter

**Organization:** Minnesota Department of Labor

**Street Address:**

**City:**

**State:**

**Zip:**

**Submittal Date:** Fri Aug 11 13:55:22 EDT 2023

**Committee:** NEC-P15

## **ARTICLE 525 Carnivals, Circuses, Fairs, and Similar Events**

### **Part I. General**

#### **525.1 Scope.**

This article covers the installation of wiring and equipment, including portable wiring in or on all structures and the permanent wiring that is as a part of a portable structure used for carnivals, circuses, fairs, and similar functions.

#### **525.3 Other Articles.**

##### **525.3(A) Portable Wiring and Equipment.**

Wherever the requirements of other articles of this *Code* and Article 525 differ, the requirements of Article 525 shall apply to the portable wiring and equipment.

##### **525.3(B) Attractions Utilizing Pools, Fountains, and Similar Installations with Contained Volumes of Water.**

This equipment shall be installed to comply with the applicable requirements of Parts I, II, III, and V of Article 680.

#### **525.5 Overhead Conductor Clearances.**

##### **525.5(A) Vertical Clearances.**

Conductors shall have a vertical clearance to ground in accordance with 225.18. These clearances shall apply only to wiring installed outside of tents, rides and concessions.

##### **525.5(B) Clearance to Portable Structures.**

Overhead clearances shall comply with either 525.5(B)(1) or 525.5(B)(2). Structures included in [525.3\(B\)](#) that contain water such as a storable pool, fountain, immersion pool, or similar portable structures shall comply with [Table 680.9\(A\)](#).

##### **525.5(B)(1) 600 Volts or Under .**

Portable structures shall be maintained not less than 4.5 m (15 ft) in any direction from overhead conductors operating at 600 volts or less, except for the conductors supplying the portable structure.

##### **525.5(B)(2) Over 600 Volts.**

Portable structures shall not be located under or within a space that is located 4.5 m (15 ft) horizontally and extending vertically to grade of conductors operating in excess of 600 volts.

#### **525.6 Protection of Electrical Equipment.**

Electrical equipment and wiring methods in or on portable structures shall be provided with mechanical protection where such equipment or wiring methods are subject to physical damage.

### **Part II. Power Sources**

#### **525.10 Services.**

Services shall comply with 525.10(A) and (B).

##### **525.10(A) Guarding.**

Service equipment shall not be installed in a location that is accessible to unqualified persons, unless the equipment is lockable.

##### **525.10(B) Mounting and Location.**

Service equipment shall be securely fastened to a solid backing and be installed so as to be protected from the weather, unless of weatherproof construction.

525.11 Generators.

Generators shall comply with 525.11(A) and (B)

525.11(A) Portable, vehicle-mounted and trailer-mounted shall comply with 250.34

525.11(B) Portable generators less than 15 KW shall comply with 445.20

### **525.12 Multiple Sources of Supply.**

Where multiple services or separately derived systems, or both, supply portable structures, the equipment grounding conductors of all the sources of supply that serve such structures separated by less than 3.7 m (12 ft) shall be bonded together at the portable structures. The bonding conductor shall be copper and sized in accordance with Table 250.122 based on the largest overcurrent device supplying the portable structures, but not smaller than 6 AWG.

## **Part III. Wiring Methods**

### **525.20 Wiring Methods.**

#### **525.20(A) Type.**

Where flexible cords or cables are used, they shall be listed for extra-hard usage. Where flexible cords or cables are used and are not subject to physical damage, they shall be permitted to be listed for hard usage. Where used outdoors, flexible cords and cables shall also be listed for wet locations and shall be sunlight resistant. Extra-hard usage flexible cords or cables shall be permitted for use as permanent wiring on portable amusement rides and attractions where not subject to physical damage.

#### **525.20(B) Single-Conductor.**

Single-conductor cable shall be permitted only in sizes 2 AWG or larger.

#### **525.20(C) Open Conductors.**

Open conductors shall be prohibited except as part of a listed assembly or festoon lighting installed in accordance with Part 1 of Article 225.

#### **525.20(D) Splices.**

Flexible cords or cables shall be continuous without splice or tap between boxes or fittings.

#### **525.20(E) Cord Connectors.**

Cord connectors shall not be laid on the ground unless listed for wet locations. Connectors and cable connections shall not be placed in areas accessible to the public unless guarded.

#### **525.20(F) Support.**

Wiring for an amusement ride, attraction, tent, or similar structure shall not be supported by any other ride or structure unless specifically designed for the purpose.

#### **525.20(G) Protection.**

Flexible cords or cables accessible to the public shall be arranged to minimize the tripping hazard and shall be permitted to be covered with nonconductive matting secured to the walkway surface or protected with another approved cable protection method, provided that the matting or other protection method does not constitute a greater tripping hazard than the uncovered cables. Burying cables shall be permitted. The requirements of 300.5 shall not apply.

#### **525.20(H) Boxes and Fittings.**

A box or fitting shall be installed at each connection point, outlet, switchpoint, or junction point in accordance with 300.15.

## **525.21 Disconnecting Means.**

### **525.21(A) Moving Ride or Attraction Disconnecting Means.**

A means to disconnect each portable ride or amusement attraction from all ungrounded conductors shall be provided. The disconnecting means shall be located within sight of and within 1.8 m (6 ft) of the operator's station. The disconnecting means shall be readily accessible to the operator, including when the ride is in operation. If accessible to unqualified persons, the disconnecting means shall be lockable. A shunt trip device that opens the fused disconnect or circuit breaker if a switch located in the ride operator's console is closed shall be a permissible method of opening the circuit. For purposes of this section, inflatable amusement attractions, slides and similar non-moving attractions shall comply with 525.21(B).

### **525.21(B) Portable Structures, Tent and Concession Disconnecting Means**

A means to disconnect each portable structure from all ungrounded conductors shall be provided. The disconnecting means shall be located inside, or outside within 1.8 m (6 ft) of the tent or concession. Enclosures with doors that, when opened, expose uninsulated live parts shall restrict access in accordance with 404.30.

Exception: Each tent supplied by a single cord and plug connection from a 125-volt, single phase, 15 or 20 amp, GFCI protected receptacle on the exterior of a permanent structure. The cord and plug connection shall be permitted to serve as a disconnecting means if located within the tent.

## **525.22 Portable Wiring Inside Tents and Concessions.**

Electrical wiring for lighting, where installed inside of tents and concessions, shall be securely installed and, where subject to physical damage, shall be provided with mechanical protection. Lamps for general illumination shall be protected from accidental breakage by a luminaire or lampholder with a guard unless the luminaire voltage is below the low voltage contact limit.

## **525.23 Portable Distribution or Termination Boxes.**

Portable distribution or termination boxes shall comply with 525.23(A) through (D).

### **525.23(A) Construction.**

Boxes shall be designed so that no live parts are exposed except where necessary for examination, adjustment, servicing, or maintenance by qualified persons. If installed outdoors, the box shall be of weatherproof construction and mounted so that the bottom of the enclosure is not less than 150 mm (6 in.) above the ground.

### **525.23(B) Busbars and Terminals.**

Busbars shall have an ampere rating not less than the overcurrent device supplying the feeder supplying the box. Where conductors terminate directly on busbars, busbar connectors shall be provided.

### **525.23(C) Receptacles and Overcurrent Protection.**

Receptacles shall have overcurrent protection installed within the box. The overcurrent protection shall not exceed the ampere rating of the receptacle.

### **525.23(D) Single-Pole Connectors.**

Where single-pole connectors are used, they shall comply with 530.10.

## **525.23 Ground-Fault Circuit-Interrupter (GFCI) Protection.**

### **525.23(A) GFCI Protection for Receptacles .**

In addition to the requirements of 210.8(B) for permanent wiring, portable rides, attractions, tents and concession receptacles shall have GFCI protection for all 125 volt, single phase, 15 and 20 amp for the following:

- (1) Non-locking-type receptacles used for disassembly and reassembly )

- (2) Receptacles within a tent or concession
- (3) Receptacles that readily accessible to the general public

The GFCI shall be permitted to be an integral part of the attachment plug or located in the power-supply cord within 300 mm (12 in.) of the attachment plug. Listed cord sets incorporating GFCI for personnel shall be permitted.

Exception No. 1: Locking type receptacles that are not accessible from grade level and that only facilitate quick disconnecting and reconnecting of electrical equipment.

Exception No. 2: When the tent or concession is being supplied from a receptacle outlet mounted on a portable generator in accordance with 445.20(A) Exception.

#### **525.23(B) GFCI Protection for Equipment**

Equipment that is readily accessible to the general public and supplied from a 125-volt, single-phase, 15- or 20-ampere branch circuit.

#### **525.23(C) GFCI Protection Is Not Permitted.**

Where a ride, tent or concession is required to have egress lighting, it shall not be protected by a GFCI.

#### **525.23(D) Receptacles Supplied by Portable Cords.**

When GFCI protection is provided through the use of GFCI receptacles, and the branch circuits supplying receptacles use flexible cord, the GFCI protection shall be listed, labeled, and identified for portable use.

### **Part IV. Equipment Grounding and Bonding**

#### **525.30 Bonding.**

The following equipment connected to the same source shall be bonded together using an equipment grounding conductor of the wire type not smaller than a 12 AWG copper conductor:

- (1) Metal raceways and metal-sheathed cable
- (2) Metal enclosures of electrical equipment
- (3) Metal frames and metal parts of portable structures, trailers, trucks, or other equipment that contain or support electrical equipment

#### **525.31 Equipment Grounding.**

The equipment grounding conductor shall be connected to the system grounded conductor at the service disconnecting means or, in the case of a separately derived system such as a generator, at the generator or first disconnecting means supplied by the generator. Exception: Portable generator used in accordance with 445.20(A) Exception

**525.32 Equipment Grounding Conductor Continuity Assurance.**The continuity of the equipment grounding conductors shall be verified each time that portable electrical equipment is connected.



## Public Input No. 2587-NFPA 70-2023 [ Section No. 525.1 ]

### 525.1 Scope.

This article covers ~~the installation of~~ portable wiring and equipment for deployed in carnivals, circuses, fairs, and similar functions, including wiring in or on all structures.

### Statement of Problem and Substantiation for Public Input

The word “deploy” and its definition properly covers the portable equipment and wiring covered in Article 525.

This PI was created by an unofficial task group consisting of:

Steve Terry CMP15  
 Wendy Russell CMP15  
 Mitch Hefter CMP15  
 Hans Lau IATSE Local 728  
 Alan Rowe CMP15  
 Mike Skinner CMP15  
 Jason Potterf CMP18  
 Bill Ellis CMP18  
 Duane Wilson CMP15

### Related Public Inputs for This Document

<u>Related Input</u>	<u>Relationship</u>
<u>Public Input No. 2585-NFPA 70-2023 [New Definition after Definition: Dental Office.]</u>	Definition of Deploy (Deployed)
<u>Public Input No. 2585-NFPA 70-2023 [New Definition after Definition: Dental Office.]</u>	

### Submitter Information Verification

**Submitter Full Name:** Steven Terry  
**Organization:** Electronic Theatre Controls In  
**Affiliation:** US Institute for Theatre Technology  
**Street Address:**  
**City:**  
**State:**  
**Zip:**  
**Submission Date:** Wed Aug 23 12:02:46 EDT 2023  
**Committee:** NEC-P15





## Public Input No. 2909-NFPA 70-2023 [ Section No. 525.1 ]

### 525.1 Scope.

This article covers the installation of portable wiring and equipment for carnivals, circuses, fairs, and similar functions, including wiring in or on all structures.

Informational Note: Definitions. Each of the following terms has a definition in Article 100 that is unique to its use in Article 525:

Operator

Portable Structures

-

### Statement of Problem and Substantiation for Public Input

The change to locations of definitions in the 2023 Edition of the NEC was controversial for many people because it reduced usability. Even though other NFPA standards use this structure and was stated as a justification to the change in the 'NEC Style Manual' (some NFPA codes and standards include definitions within articles \*), many believe this relocation leads to confusion among users, especially for those articles that are specialty topics – i.e., the articles in Chapters 5 through 8. There are over 37 pages of definitions in Article 100 to search through.

Common language terms often have more specific meanings within an article. One only needs to look at the multiple definitions for 'Portable Equipment' to get a sense of this issue. Another example is 'Bundled' – specific to Article 520 – while 'Cable Bundle' is defined in Article 100 differently but not article specific. 'Operator' is defined for Article 5125, but without its proximate reference, the specific meaning for the user is unclear.

Under the current structure, important specialty definitions are lost in the sheer size of the Article 100 list. The usability of the NEC has been damaged, and users of specialty articles in Chapters 5 through 8 need help with this structure.

To restore the usability of the NEC, what is needed is a way to clearly identify and point to specialty definitions in a standardized location within articles, while leaving the definitions themselves in Article 100. NFPA Link and the NEC Handbook add this information as Enhanced Content. Additionally, this "definition identification" model has proven its usability in other codes such as NFPA 1, NFPA 99, and NFPA 101. The NEC deserves no less.

\* Example: NFPA 101 – Section 6.1.2.1 'Assembly Occupancy' is one of several definitions in an Article; and in this instance it is duplicated from 3.3.205.2]. In fact, there are multiple definitions throughout NFPA 101.

### Submitter Information Verification

**Submitter Full Name:** Mitchell Hefter

**Organization:** Signify

**Street Address:**

**City:**

**State:**

**Zip:**

<b>Submittal Date:</b>	Sat Aug 26 16:03:48 EDT 2023
<b>Committee:</b>	NEC-P15



## Public Input No. 1146-NFPA 70-2023 [ Section No. 525.3(A) ]

(A) Portable Wiring and Equipment.

Wherever the requirements of other articles of this *Code* and Article- 525 -differ this article differ , the requirements of Article- 525 -shall- this article shall apply to the portable wiring and equipment.

### Statement of Problem and Substantiation for Public Input

Section 4.1.4 of the NEC® Style Manual prohibits reference to an entire article other than Article 100 or where required for context. As such, it is suggested that we change the language here simply referring to "this article" to comply with the Style Manual.

### Submitter Information Verification

**Submitter Full Name:** Richard Holub

**Organization:** The DuPont Company, Inc.

**Street Address:**

**City:**

**State:**

**Zip:**

**Submittal Date:** Tue Jun 20 12:52:04 EDT 2023

**Committee:** NEC-P15



## Public Input No. 2588-NFPA 70-2023 [ Section No. 525.3(A) ]

### (A) Portable Wiring and Equipment.

Wherever the requirements of other articles of this *Code* and Article 525 differ, the requirements of Article 525 shall apply to the deployment of portable wiring and equipment.

## Statement of Problem and Substantiation for Public Input

The words “install” / “installed” are normally associated with permanent installations. Portable equipment is not permanently installed in venues covered by the “Entertainment Industry” Articles 518, 520, 525, and 530. Use of the words “deploy” / “deployed” is more descriptive of the portable equipment use and prevents misinterpretation. It also provides additional distinction from Article 590 – Temporary Installation which is often erroneously applied to portable equipment deployed under the Entertainment Articles.

This PI was created by an unofficial task group consisting of:

Steve Terry CMP15  
 Wendy Russell CMP15  
 Mitch Hefter CMP15  
 Hans Lau IATSE Local 728  
 Alan Rowe CMP15  
 Mike Skinner CMP15  
 Jason Potterf CMP18  
 Bill Ellis CMP18  
 Duane Wilson CMP15

## Related Public Inputs for This Document

<u>Related Input</u>	<u>Relationship</u>
<a href="#">Public Input No. 2585-NFPA 70-2023 [New Definition after Definition: Dental Office.]</a>	Definition of Deploy (Deployed)
<a href="#">Public Input No. 2585-NFPA 70-2023 [New Definition after Definition: Dental Office.]</a>	

## Submitter Information Verification

**Submitter Full Name:** Steven Terry  
**Organization:** Electronic Theatre Controls In  
**Affiliation:** US Institute for Theatre Technology  
**Street Address:**  
**City:**  
**State:**  
**Zip:**  
**Submission Date:** Wed Aug 23 12:33:58 EDT 2023  
**Committee:** NEC-P15



## Public Input No. 2756-NFPA 70-2023 [ Section No. 525.3(B) ]

**(B)** Attractions Utilizing Pools, Fountains, and Similar Installations with Contained Volumes of Water.

This equipment shall be installed to comply with the applicable requirements of Article 680, Parts I, II, III, and V- ~~of Article 680~~ .

### Statement of Problem and Substantiation for Public Input

This Public Input is being submitted on behalf of the NEC Correlating Committee Usability Task Group in order to provide correlation throughout the document. The text is revised to comply with the NEC Style Manual Section 4.1.4, regarding the use of Parts.

4.1.4 References to an Entire Article. References shall not be made to an entire article, except for the Article 100 or where referenced to provide the necessary context. References to specific parts within articles shall be permitted. References to all parts of an article shall not be permitted. The article number shall precede the part number.

The Usability Task Group members are: Derrick Atkins, David Hittinger, Richard Holub, Dean Hunter, Chad Kennedy and David Williams.

### Submitter Information Verification

**Submitter Full Name:** David Williams

**Organization:** Delta Charter Township

**Street Address:**

**City:**

**State:**

**Zip:**

**Submittal Date:** Thu Aug 24 20:05:06 EDT 2023

**Committee:** NEC-P15



## Public Input No. 1147-NFPA 70-2023 [ Section No. 525.20(C) ]

### (C) Open Conductors.

Open conductors shall be prohibited except as part of a listed assembly or festoon lighting installed in accordance with Article 225, Part I.

### Statement of Problem and Substantiation for Public Input

Section 4.1.4 of the NEC® Style Manual prohibits reference to an entire article other than Article 100 or where required for context. As such, it is recommended to refer to the part of the article which applies, and for festoon lighting, it appears this should be Part I of Article 225.

### Submitter Information Verification

**Submitter Full Name:** Richard Holub

**Organization:** The DuPont Company, Inc.

**Street Address:**

**City:**

**State:**

**Zip:**

**Submittal Date:** Tue Jun 20 13:00:26 EDT 2023

**Committee:** NEC-P15



## Public Input No. 1149-NFPA 70-2023 [ Section No. 525.22(C) ]

### (C) Receptacles and Overcurrent Protection.

Receptacles shall have overcurrent protection installed within the box. The overcurrent protection shall not exceed the ampere rating of the receptacle, except as permitted in Article 430 ~~for~~ elsewhere for motor loads.

### Statement of Problem and Substantiation for Public Input

Section 4.1.4 of the NEC® Style Manual prohibits reference to an entire article with the exception of Article 100 or where required for context. It is obvious that reference here for "motor loads" would look in Article 430 and both the index and table of contents of the Code can lead a user to the appropriate article. This proposed revision would address the style manual concerns without changing the intent of the code section, here.

### Submitter Information Verification

**Submitter Full Name:** Richard Holub

**Organization:** The DuPont Company, Inc.

**Street Address:**

**City:**

**State:**

**Zip:**

**Submittal Date:** Tue Jun 20 13:03:49 EDT 2023

**Committee:** NEC-P15



## Public Input No. 96-NFPA 70-2023 [ Section No. 525.23(A) ]

### (A) Where GFCI Protection Is Required.

In addition to the requirements of 210.8(B), GFCI protection for personnel shall be provided for the following:

- (1) All 125-volt, single-phase, 15- and 20-ampere non-locking-type receptacles used for disassembly and reassembly or readily accessible to the general public
- (2) Equipment that is readily accessible to the general public and supplied from a 425 120 - volt nominal , - ~~single~~ single -phase, 15- or 20-ampere branch circuit

The GFCI shall be permitted to be an integral part of the attachment plug or located in the power-supply cord within 300 mm (12 in.) of the attachment plug. Listed cord sets incorporating GFCI for personnel shall be permitted.

### Statement of Problem and Substantiation for Public Input

Is the voltage specified here a “nominal voltage” or the “circuit voltage”? Article 100 provides several different definitions for voltage including “voltage, nominal” and “voltage, of a circuit”. Section 110.4 tells us that the “voltage considered shall be that at which the circuit operates”. Putting these Code pieces together would literally mean GFCI protection is not required for branch circuits operating at 118V, 120V, 124V or any voltage other than 125V. I don’t think the intent is to exclude those circuits from the GFCI protection requirements. I think the intent is to apply the requirements to “120-volt, nominal” branch circuits.

### Related Public Inputs for This Document

<u>Related Input</u>	<u>Relationship</u>
Public Input No. 23-NFPA 70-2023 [Sections 210.11(C)(3), 210.11(C)(4)]	nominal vs circuit voltage
Public Input No. 16-NFPA 70-2023 [Sections 210.12(B), 210.12(C), 210.12(D)]	nominal vs circuit voltage

### Submitter Information Verification

**Submitter Full Name:** Russ Leblanc  
**Organization:** Leblanc Consulting Services  
**Street Address:**  
**City:**  
**State:**  
**Zip:**  
**Submittal Date:** Wed Jan 11 11:20:59 EST 2023  
**Committee:** NEC-P15





## Public Input No. 1073-NFPA 70-2023 [ Section No. 525.23(C) ]

(C) Where GFCI Protection Is Not Permitted.

Egress lighting shall not be protected by a GFCI. Egress lighting shall be listed.

### Statement of Problem and Substantiation for Public Input

In article 525.23 (C), it does not allow for egress lighting to be installed with GFCI protection. However, the user could potentially be tempted to make/create any sort of egress lighting with no listing and with the current language, will not be GFCI protected either. This could present a safety hazard in the carnival, circus, fair, or similar environment being most of these are moved often and are not permanent in nature. I feel the article is ok without GFCI protection for the possibility of nuisance tripping of the egress lighting circuit, hindering illuminated egress of a space. However, the potential of an unlisted product could be used in conjunction without having GFCI protection. Also, mentioning the requirement of listing egress lighting works in parallel with, or is similar to, the following article which is 525.23 (D), and it's mentioning of listing and labeling, etc.

### Submitter Information Verification

**Submitter Full Name:** Clinton Stoddard  
**Organization:** City of Rexburg  
**Affiliation:** N/A  
**Street Address:**  
**City:**  
**State:**  
**Zip:**  
**Submittal Date:** Wed Jun 14 11:34:15 EDT 2023  
**Committee:** NEC-P15



## Public Input No. 3763-NFPA 70-2023 [ New Section after 530.1 ]

### 530.2 Listing Requirements.

The following equipment shall be listed:

- (1) Portable stage and studio electrical equipment
- (2) Alternating-current power distribution boxes
- (3) Portable luminaires
- (4) Portable enclosed-arc lamps and associated ballasts

### Statement of Problem and Substantiation for Public Input

This Public Input is being submitted on behalf of the NEC Correlating Committee Usability Task Group in order to provide correlation throughout the document. A new section is added to comply with the NEC Style Manual Section 2.2.1 regarding Listing Requirements.

2.2.1 Parallel Numbering Required. Technical committees shall use the following section numbers for the same purposes within articles. This requirement shall not apply to Articles 90, 100, and 110. If the article does not contain listing or reconditioning requirements, the subdivisions shall not be included in the article.

Required Parallel Numbering Format

XXX.1 Scope.

XXX.2 Listing Requirements.

XXX.3 Reconditioned Equipment.

XXX.3(A) Permitted to be Installed.

XXX.3(B) Not Permitted to be Installed.

The Usability Task Group members are: Derrick Atkins, David Hittinger, Richard Holub, Dean Hunter, Chad Kennedy and David Williams.

### Submitter Information Verification

**Submitter Full Name:** David Williams

**Organization:** Delta Charter Township

**Street Address:**

**City:**

**State:**

**Zip:**

**Submittal Date:** Tue Sep 05 15:42:14 EDT 2023

**Committee:** NEC-P15



## Public Input No. 2910-NFPA 70-2023 [ Section No. 530.1 ]

### 530.1 Scope.

The requirements of this article shall apply to motion picture and television studios in facilities and locations staffed by qualified persons, except as provided in 520.1. Such occupancies shall include those using either electronic or film cameras for image capture.

Informational Note No. 1 : See NFPA 40-2019, *Standard for the Storage and Handling of Cellulose Nitrate Film*, for methods of protecting against cellulose nitrate film hazards.

Informational Note No. 2: Definitions. Each of the following terms has a definition in Article 100 that is unique to its use in Article 530:

Bull switch

DC plugging box

Motion picture studio

Portable equipment

Portable substation

Production areas

Purpose-built

Remote location

Spider (cable splicing block)

Stage property

Support area

Informational Note No. 3: Definitions. Each of the following terms has a definition in Article 100 that appears in several articles but is important in its use in Article 530:

Solid-State Phase-Control Dimmer

Solid-State Sine Wave Dimmer

Stage Effect (Special Effect)

Stage Set

Stage Switchboard, Fixed (Fixed Stage Switchboard)

-

### Statement of Problem and Substantiation for Public Input

The change to locations of definitions in the 2023 Edition of the NEC was controversial for many people because it reduced usability. Even though other NFPA standards use this structure and was stated as a justification to the change in the 'NEC Style Manual' (some NFPA codes and standards include definitions within articles \*), many believe this relocation leads to confusion among users,

especially for those articles that are specialty topics – i.e., the articles in Chapters 5 through 8. There are over 37 pages of definitions in Article 100 to search through.

Common language terms often have more specific meanings within an article. One only needs to look at the multiple definitions for 'Portable Equipment' to get a sense of this issue. Another example is 'Bundled' – specific to Article 520 – while 'Cable Bundle' is defined in Article 100 differently but not article specific. While 'Spider' may raise a flag with a user that there is a unique definition, 'Support Area' is not as likely – hence a proximate reference within Article 530 is important for proper understanding.

Under the current structure, important specialty definitions are lost in the sheer size of the Article 100 list. The usability of the NEC has been damaged, and users of specialty articles in Chapters 5 through 8 need help with this structure.

To restore the usability of the NEC, what is needed is a way to clearly identify and point to specialty definitions in a standardized location within articles, while leaving the definitions themselves in Article 100. NFPA Link and the NEC Handbook add this information as Enhanced Content. Additionally, this "definition identification" model has proven its usability in other codes such as NFPA 1, NFPA 99, and NFPA 101. The NEC deserves no less.

\* Example: NFPA 101 – Section 6.1.2.1 'Assembly Occupancy' is one of several definitions in an Article; and in this instance it is duplicated from 3.3.205.2]. In fact, there are multiple definitions throughout NFPA 101.

## Submitter Information Verification

**Submitter Full Name:** Mitchell Hefter

**Organization:** Signify

**Street Address:**

**City:**

**State:**

**Zip:**

**Submittal Date:** Sat Aug 26 16:06:03 EDT 2023

**Committee:** NEC-P15



## Public Input No. 3235-NFPA 70-2023 [ Section No. 530.4 ]

### 530.4 Supervision by Qualified Personnel.

Portable electrical equipment covered in this article , including portable distribution systems, generators, battery systems, and other portable power sources, shall be deployed, energized, and, while energized, operated and continuously supervised by trained, qualified, and employer-authorized personnel.

*Exception: Continuous supervision shall not be required for utility-supplied portable distribution equipment used supply other than professional stage and studio equipment.*

### Statement of Problem and Substantiation for Public Input

The existing language is too overarching and the requirement for continuous supervision should not apply to utility-supplied portable distribution systems supplying equipment on motion picture or television studio lots such as video trucks, satellite trucks, portable UPS, portable power tools, portable air conditioning units, support trailers, craft service refrigerators, and similar equipment, that are required to operate 24/7. Changes in the language are meant to narrow down the scope of this section, and the exception would allow portable equipment, supplied by utility power and designed for the purpose, to supply other equipment without continuous supervision. The equipment is still required to be deployed and energized by qualified persons.

### Submitter Information Verification

**Submitter Full Name:** Michael Skinner

**Organization:** Contract Services Administration Trust Fund

**Street Address:**

**City:**

**State:**

**Zip:**

**Submittal Date:** Wed Aug 30 15:33:36 EDT 2023

**Committee:** NEC-P15



## Public Input No. 2757-NFPA 70-2023 [ Section No. 530.5(B) ]

**(B)** Communications, Signaling Systems, Data Systems, Fire Alarm Systems, and Systems Less than 120 Volts, Nominal.

Permanent wiring methods for communications, signaling, data, fire alarm systems, and systems operating at less than 120 volts, nominal, shall be in accordance with the following:

- (1) Audio signal processing, amplification, and reproduction equipment — 640.9
- (2) Communications systems — Article 800, Parts I and IV of Article 800 ; Part IV of Article 805, Part IV ; and Part IV of Article 840, Part IV
- (3) Class 2 and Class 3 remote control and signaling circuits — Part III of Article 725, Part III
- (4) Class 2 circuits that transmit power, data or both to a powered device

Informational Note: See ANSI/NEMA C137.3-2017, *American National Standard for Lighting Systems — Minimum Requirements for Installation of Energy Efficient Power over Ethernet (PoE) Lighting Systems*, for information on installation of cables for PoE lighting systems. See Part III of Article 760 for Part III for information on fire alarm circuits.

### Statement of Problem and Substantiation for Public Input

This Public Input is being submitted on behalf of the NEC Correlating Committee Usability Task Group in order to provide correlation throughout the document. The text is revised to to comply with the NEC Style Manual Section 4.1.4, regarding the use of Parts.

4.1.4 References to an Entire Article. References shall not be made to an entire article, except for the Article 100 or where referenced to provide the necessary context. References to specific parts within articles shall be permitted. References to all parts of an article shall not be permitted. The article number shall precede the part number.

The Usability Task Group members are: Derrick Atkins, David Hittinger, Richard Holub, Dean Hunter, Chad Kennedy and David Williams.

### Submitter Information Verification

**Submitter Full Name:** David Williams

**Organization:** Delta Charter Township

**Street Address:**

**City:**

**State:**

**Zip:**

**Submittal Date:** Thu Aug 24 20:07:06 EDT 2023

**Committee:** NEC-P15



## Public Input No. 4171-NFPA 70-2023 [ Section No. 530.5(B) ]

**(B)** Communications, Signaling Systems, Data Systems, Fire Alarm Systems, and Systems Less than 120 Volts, Nominal.

Permanent wiring methods for communications, signaling, data, fire alarm systems, and systems operating at less than 120 volts, nominal, shall be in accordance with the following:

- (1) Audio signal processing, amplification, and reproduction equipment — 640.9
- (2) Communications systems — Parts I and IV of Article 800; Part IV of Article 805; and Part IV of Article 840
- (3) Class 2 and Class 3 remote control and signaling circuits — ~~Part III of~~ Part II of Article 725
- (4) Class 2 circuits that transmit power, data or both to a powered device
- (5) Class 4 fault managed power circuits - Part II of Article 726

Informational Note: See ANSI/NEMA C137.3-2017, *American National Standard for Lighting Systems — Minimum Requirements for Installation of Energy Efficient Power over Ethernet (PoE) Lighting Systems*, for information on installation of cables for PoE lighting systems. See Part III of Article 760 for information on fire alarm circuits.

### Statement of Problem and Substantiation for Public Input

First, article 725 underwent big edits for 2023. Looks like this reference was not updated, fixing the pointer to Part II instead of Part III. Part III became Part II in 2023 when Class 1 circuits were moved to their own article.

Second, adding Class 4 to the list. Class 4 systems were added in the 2023 code and have equivalent or better than fire and life safety requirements as Class 2 circuits. An effort to analyze all the locations of Class 2 in the code to see if Class 4 was also appropriate in the application should have happened for the 2023 code and not doing it was an oversight.

### Submitter Information Verification

**Submitter Full Name:** Chad Jones

**Organization:** Cisco Systems

**Street Address:**

**City:**

**State:**

**Zip:**

**Submittal Date:** Wed Sep 06 19:22:40 EDT 2023

**Committee:** NEC-P15



## Public Input No. 4303-NFPA 70-2023 [ Section No. 530.5(B) ]

**(B) Communications, Signaling Systems, Data Systems, Fire Alarm Systems, and Systems Less than 120 Volts, Nominal .**

Permanent wiring methods for communications, signaling, data, fire alarm systems, and systems operating at less than 120 volts, nominal, shall be in accordance with the following:

- (1) Audio signal processing, amplification, and reproduction equipment — 640.9
- (2) Communications systems — Parts I and IV of Article 800; Part IV of Article 805; and Part IV of Article 840
- (3) Class 2 and Class 3 remote control and signaling circuits — Part III of Article 725
- (4) Class 2 circuits that transmit power, data or both to a powered device

Informational Note: See ANSI/NEMA C137.3-2017, *American National Standard for Lighting Systems — Minimum Requirements for Installation of Energy Efficient Power over Ethernet (PoE) Lighting Systems*, for information on installation of cables for PoE lighting systems. See Part III of Article 760 for information on fire alarm circuits.

### Statement of Problem and Substantiation for Public Input

This section includes ", and Systems Less Than 120 Volts, Nominal" in the title, yet the list of wiring methods do not include any specific to systems less than 120 volts nominal. Further, the title can cause confusion as it may appear that the wiring methods listed can be used with higher voltages than the referenced requirements actually allow. This phrase in the title appears to be vestigial, and came from 517, but serves no useful purpose here and should be deleted.

### Related Public Inputs for This Document

<u>Related Input</u>	<u>Relationship</u>
<a href="#">Public Input No. 4299-NFPA 70-2023 [Section No. 518.4(B)]</a>	Same language that needs to be removed
<a href="#">Public Input No. 4301-NFPA 70-2023 [Section No. 520.5(B)]</a>	Same language that needs to be removed

### Submitter Information Verification

**Submitter Full Name:** Jason Potterf  
**Organization:** Cisco  
**Affiliation:** ESTA  
**Street Address:**  
**City:**  
**State:**  
**Zip:**  
**Submittal Date:** Thu Sep 07 10:22:38 EDT 2023  
**Committee:** NEC-P15





## Public Input No. 2088-NFPA 70-2023 [ Section No. 530.21(A) ]

### (A) Listing.

Portable stage and studio electrical equipment shall be listed or approved. Field-assembled ~~extension cords~~ cord sets and multiconductor cable assemblies consisting of listed connectors and cable shall be permitted in production areas.

### Statement of Problem and Substantiation for Public Input

The term 'extension cords' is not defined. Adding the word 'cord sets' to make the text technically correct. The term 'cord set' is an NEC Article 100 defined term.

### Submitter Information Verification

**Submitter Full Name:** Mike Holt

**Organization:** Mike Holt Enterprises Inc

**Street Address:**

**City:**

**State:**

**Zip:**

**Submittal Date:** Fri Aug 11 15:51:00 EDT 2023

**Committee:** NEC-P15



## Public Input No. 699-NFPA 70-2023 [ Section No. 530.21(A) ]

### (A) Listing.

~~Portable stage and studio electrical equipment shall be listed or approved.~~ Field-assembled extension cords and multiconductor cable assemblies consisting of listed connectors and cable shall be permitted in production areas.

### Statement of Problem and Substantiation for Public Input

Everything has to be approved. See 110.2. This language is somehow removing that requirement by saying if the equipment is listed it does not need to be approved. That goes against the entire concept of having an AHJ.

### Submitter Information Verification

**Submitter Full Name:** Ryan Jackson

**Organization:** Self-employed

**Street Address:**

**City:**

**State:**

**Zip:**

**Submittal Date:** Thu Apr 20 15:57:34 EDT 2023

**Committee:** NEC-P15



## Public Input No. 2213-NFPA 70-2023 [ Section No. 530.21(B) ]

### (B) Outdoor Use.

Portable stage and studio equipment and portable power distribution equipment not identified for outdoor use shall be permitted for ~~temporary use~~ to be deployed outdoors if the equipment is supervised by qualified personnel while energized and barriered from the general public.

Informational Note No. 1: See ANSI/ESTA E1.58, *Electrical Safety Standard for Portable Stage and Studio Equipment Used Outdoors*, for ~~requirements covering temporary outdoor~~

information on the use of

~~equipment not identified for outdoor use~~

portable stage and studio lighting equipment outdoors .

Informational Note No. 2: See ANSI/ESTA E1.19-2015 2021 , *Recommended Practice for the use of Class A Ground-Fault Circuit Interrupters (GFCIs) intended for personnel protection in the Entertainment Industry*, for guidance on the use of GFCIs in wet locations.

## Statement of Problem and Substantiation for Public Input

Using the word “temporary” in this section may be improperly interpreted as being covered by Article 590 – Temporary Installations. Portable equipment is not permanently installed in venues covered by the “Entertainment Industry” Articles 518, 520, 525, and 530. Use of the words “deploy” / “deployed” is more descriptive of the portable equipment use and prevents misinterpretation.

This PI was created by an unofficial task group consisting of:

Steve Terry CMP15  
 Wendy Russell CMP15  
 Mitch Hefter CMP15  
 Hans Lau IATSE Local 728  
 Alan Rowe CMP15  
 Mike Skinner CMP15  
 Jason Potterf CMP18  
 Bill Ellis CMP18  
 Duane Wilson CMP15

## Related Public Inputs for This Document

<u>Related Input</u>	<u>Relationship</u>
<u>Public Input No. 2585-NFPA 70-2023 [New Definition after Definition: Dental Office.]</u>	New definition of Deploy (Deployed)
<u>Public Input No. 2585-NFPA 70-2023 [New Definition after Definition: Dental Office.]</u>	

## Submitter Information Verification

**Submitter Full Name:** Steven Terry

<b>Organization:</b>	Electronic Theatre Controls In
<b>Affiliation:</b>	US Institute for Theatre Technology
<b>Street Address:</b>	
<b>City:</b>	
<b>State:</b>	
<b>Zip:</b>	
<b>Submittal Date:</b>	Tue Aug 15 09:14:33 EDT 2023
<b>Committee:</b>	NEC-P15



## Public Input No. 2694-NFPA 70-2023 [ Section No. 530.72 ]

**530.72** Over 1000 Volts, Nominal.

Wiring and equipment of portable substations rated over 1000 volts, nominal, shall comply with the requirements of Article 495, Part IV- ~~of Article 490~~ .

### Statement of Problem and Substantiation for Public Input

This Public Input is being submitted on behalf of the NEC Correlating Committee Usability Task Group in order to provide correlation throughout the document. The text is revised to to comply with the NEC Style Manual Section 4.1.4, regarding the use of Parts.

4.1.4 References to an Entire Article. References shall not be made to an entire article, except for the Article 100 or where referenced to provide the necessary context. References to specific parts within articles shall be permitted. References to all parts of an article shall not be permitted. The article number shall precede the part number.

The Usability Task Group members are: Derrick Atkins, David Hittinger, Richard Holub, Dean Hunter, Chad Kennedy and David Williams.

Thre current referenced article is inaccurate.

### Submitter Information Verification

**Submitter Full Name:** David Williams

**Organization:** Delta Charter Township

**Street Address:**

**City:**

**State:**

**Zip:**

**Submittal Date:** Thu Aug 24 13:44:33 EDT 2023

**Committee:** NEC-P15



## Public Input No. 3414-NFPA 70-2023 [ Section No. 530.72 ]

**530.72** Over 1000 Volts, Nominal.

Wiring and equipment of portable substations rated over 1000 volts, nominal, shall comply with the requirements of Part IV of Article 490 495 .

### Statement of Problem and Substantiation for Public Input

Article 490 was renumbered to 495. This edit to reflect the correct Article number.

### Submitter Information Verification

**Submitter Full Name:** Mathher Abbassi

**Organization:** Abbassi Electric Corp.

**Street Address:**

**City:**

**State:**

**Zip:**

**Submittal Date:** Sat Sep 02 18:02:17 EDT 2023

**Committee:** NEC-P15



## Public Input No. 3800-NFPA 70-2023 [ Section No. 530.72 ]

**530.72** Over 1000 Volts, Nominal.

Wiring and equipment of portable substations rated over 1000 volts, nominal, shall comply with the requirements of Part IV of Article 490 495 .

### Statement of Problem and Substantiation for Public Input

Article 490 was re-numbered to Article 495 in the 2023 NEC as part of the MV task group work and the reference is no longer accurate

### Submitter Information Verification

**Submitter Full Name:** Rudy Garza

**Organization:** IAEI

**Street Address:**

**City:**

**State:**

**Zip:**

**Submittal Date:** Tue Sep 05 17:06:50 EDT 2023

**Committee:** NEC-P15



## Public Input No. 2911-NFPA 70-2023 [ Section No. 540.1 ]

### 540.1 Scope.

This article applies to motion picture projection rooms, motion picture projectors, and associated equipment of the professional and nonprofessional types using incandescent, carbon arc, xenon, or other light source equipment that develops hazardous gases, dust, or radiation.

Informational Note No.1 : See NFPA 40-2019, *Standard for the Storage and Handling of Cellulose Nitrate Film*, for further information.

Informational Note No. 2: Definitions. Each of the following terms has a definition in Article 100 that is unique to its use in Article 540:

Nonprofessional projector

Professional-type projector

-

## Statement of Problem and Substantiation for Public Input

The change to locations of definitions in the 2023 Edition of the NEC was controversial for many people because it reduced usability. Even though other NFPA standards use this structure and was stated as a justification to the change in the 'NEC Style Manual' (some NFPA codes and standards include definitions within articles \*), many believe this relocation leads to confusion among users, especially for those articles that are specialty topics – i.e., the articles in Chapters 5 through 8. There are over 37 pages of definitions in Article 100 to search through.

Common language terms often have more specific meanings within an article. One only needs to look at the multiple definitions for 'Portable Equipment' to get a sense of this issue. Another example is 'Bundled' – specific to Article 520 – while 'Cable Bundle' is defined in Article 100 differently but not article specific. In Article 540, the term Professional-type Projector is very specific, but without the proximate reference, the important distinction of this type of projector may be overlooked by the user.

Under the current structure, important specialty definitions are lost in the sheer size of the Article 100 list. The usability of the NEC has been damaged, and users of specialty articles in Chapters 5 through 8 need help with this structure.

To restore the usability of the NEC, what is needed is a way to clearly identify and point to specialty definitions in a standardized location within articles, while leaving the definitions themselves in Article 100. NFPA Link and the NEC Handbook add this information as Enhanced Content. Additionally, this "definition identification" model has proven its usability in other codes such as NFPA 1, NFPA 99, and NFPA 101. The NEC deserves no less.

\* Example: NFPA 101 – Section 6.1.2.1 'Assembly Occupancy' is one of several definitions in an Article; and in this instance it is duplicated from 3.3.205.2]. In fact, there are multiple definitions throughout NFPA

## Submitter Information Verification

**Submitter Full Name:** Mitchell Hefter

**Organization:** Signify

**Street Address:**

**City:**



**State:**

**Zip:**

**Submittal Date:** Sat Aug 26 16:09:25 EDT 2023

**Committee:** NEC-P15



## Public Input No. 1150-NFPA 70-2023 [ Section No. 540.10 ]

### **540.10** Motion Picture Projection Room Required.

Every professional-type projector shall be located within a projection room. Every projection room shall be of permanent construction and approved for the type of building in which it is located. All projection ports, spotlight ports, viewing ports, and similar openings shall be provided with glass or other approved material to completely close the opening. Such rooms shall not be considered hazardous (classified) locations as defined in ~~Article in~~ 500.5, 505.5, or 506.5.

Informational Note: See NFPA 101-2021, *Life Safety Code*, for further information on protecting openings in projection rooms handling cellulose nitrate motion picture film.

### Statement of Problem and Substantiation for Public Input

Section 4.1.4 of the NEC® Style Manual prohibits reference to an entire article with the exception of Article 100 or where required for context. As such, this section could either be revised to reference "as defined elsewhere in this code", or instead as recommended point to the specific sections of the relevant articles. Hazardous (classified) locations are described in 501.5, 505.5, and 506.5 depending on whether the division or zone system is used, so this reference should either be generic as recommended or complete and identify each of the 3 appropriate sections as recommended.

### Submitter Information Verification

**Submitter Full Name:** Richard Holub

**Organization:** The DuPont Company, Inc.

**Street Address:**

**City:**

**State:**

**Zip:**

**Submittal Date:** Tue Jun 20 13:09:02 EDT 2023

**Committee:** NEC-P15



## Public Input No. 3772-NFPA 70-2023 [ Section No. 540.20 ]

### **540.20 – 2** Listing Requirements.

Projectors and enclosures for arc, xenon, and incandescent lamps and rectifiers, transformers, rheostats, and similar equipment shall be listed.

### Statement of Problem and Substantiation for Public Input

This Public Input is being submitted on behalf of the NEC Correlating Committee Usability Task Group in order to provide correlation throughout the document. A new section is added to comply with the NEC Style Manual Section 2.2.1 regarding Listing Requirements.

2.2.1 Parallel Numbering Required. Technical committees shall use the following section numbers for the same purposes within articles. This requirement shall not apply to Articles 90, 100, and 110. If the article does not contain listing or reconditioning requirements, the subdivisions shall not be included in the article.

Required Parallel Numbering Format

XXX.1 Scope.

XXX.2 Listing Requirements.

XXX.3 Reconditioned Equipment.

XXX.3(A) Permitted to be Installed.

XXX.3(B) Not Permitted to be Installed.

The Usability Task Group members are: Derrick Atkins, David Hittinger, Richard Holub, Dean Hunter, Chad Kennedy and David Williams.

### Submitter Information Verification

**Submitter Full Name:** David Williams

**Organization:** Delta Charter Township

**Street Address:**

**City:**

**State:**

**Zip:**

**Submission Date:** Tue Sep 05 15:52:13 EDT 2023

**Committee:** NEC-P15



## Public Input No. 1175-NFPA 70-2023 [ Definition: Patient Care Space Category.

[Excluding any Sub... ]

Any space of a health care facility wherein patients are intended to be examined or treated. [99:3.3.140] (517) (CMP-15)

~~Informational Note No. 1 : The health care facility's governing body designates patient care space in accordance with the type of patient care anticipated. Informational Note No. 2: Business offices, corridors, lounges, day rooms, dining rooms, or similar areas typically are not classified as patient care spaces. [99:A.3.3.140]~~

### Statement of Problem and Substantiation for Public Input

The distinctly separate responsibilities for RISK CATEGORY ASSIGNMENT (conducted by the Health Care Facility's Governing Body) of the patient care space versus for ENFORCEMENT (conducted by the AHJ) are explicitly delineated in NFPA 99, Health Care Facilities Code. By contrast, those same responsibilities are unstated in NFPA 70® except as an unenforceable Informational Note.

Consequently, for those installers and electrical inspectors who utilize primarily or solely NEC® Article 517 (i.e. rarely use NFPA 99), jurisdictional confusion arises between, on one hand, NON-MEDICALLY-TRAINED electrical installers and electrical inspection enforcers and, on the other hand, operators of the smaller health care facilities located at those otherwise-ordinarily-commercial occupancies as to:

- whether it's the electrical inspector (AHJ) or Health Care Facility's Governing Body (c.f., Article 100 definition) who has authority and responsibility to ASSIGN AND DESIGNATE which Category number for any given space Patient Care Space, and
- whether Part II of Article 517 applies.

This Public Input seeks to delete UNENFORCEABLE Informational Note No. 1 that is presently MANDATORY AND ENFORCEABLE in NFPA 99, Health Care Facilities Code. A companion Public Input in turn will seek correlation by adding NEW ENFORCEABLE extracts from NFPA 99 to Part I General of Article 517 for ASSESSMENT AND ASSIGNMENT of Patient Care Space Categories already long required by NFPA 99, Health Care Facilities Code.

Consequently, NON-MEDICALLY-TRAINED electrical installers and electrical inspection enforcers are effectively making medical risk decisions for which they are unwittingly assuming potential liability, based upon the management of some health care facilities "playing dumb" electrically to avoid incurring the essential safety requirements of Part II of Article 517.

### Related Public Inputs for This Document

<u>Related Input</u>	<u>Relationship</u>
<a href="#">Public Input No. 1171-NFPA 70-2023 [New Section after 517.6]</a>	Enforceable requirement addition as a NEW Section
<a href="#">Public Input No. 1171-NFPA 70-2023 [New Section after 517.6]</a>	

### Submitter Information Verification

**Submitter Full Name:** Brian Rock  
**Organization:** Hubbell Incorporated  
**Street Address:**

**City:**

**State:**

**Zip:**

**Submittal Date:** Thu Jun 22 05:22:28 EDT 2023

**Committee:** NEC-P15



## Public Input No. 4473-NFPA 70-2023 [ Part I. ]

### Part I. General

Something for the suggestion box: Please move a few of the Article 517 figures into the front part of this Article. In the printed version, Figures from the previous Article 516 appear on the first few pages of Article 517.

### Statement of Problem and Substantiation for Public Input

In the printed version, Figures from the previous Article 516 appear on the first few pages of Article 517. Something for the graphic production team to work out. Respectfully submitted.

### Submitter Information Verification

**Submitter Full Name:** Michael Anthony

**Organization:** Standards Michigan LLC

**Affiliation:** StandardsMichigan.COM

**Street Address:**

**City:**

**State:**

**Zip:**

**Submittal Date:** Thu Sep 07 16:07:28 EDT 2023

**Committee:** NEC-P15



## Public Input No. 3606-NFPA 70-2023 [ Section No. 220.110 ]

### 220.110 Receptacle Loads.

Receptacle loads calculated in accordance with 220.14(H) and (I) and supplied by branch circuits not exceeding 150 volts to ground shall be permitted to be subjected to the demand factors provided in Table 220.110(1) and Table 220.110(2) for health care facilities.

Informational Note No. 1: See Article 100 for the definitions of patient care space categories.

Informational Note No. 2: See 220.14(I) for the calculation of receptacle outlet loads.

Table 220.110(1) Demand Factors for Receptacles Supplied by General-Purpose Branch Circuits in Category 1, Category 2, Category 3, and Category 4 Patient Care Spaces

<u>Portion of Receptacle Load to Which Demand Factor Applies (Volt-Amperes)</u>	<u>Demand Factor (%)</u>
First 5000 or less	100
From 5001 to 10,000	50
-	-
Remainder over 10,000	25

Table 220.110(2) Demand Factors for Receptacles Supplied by General-Purpose Branch Circuits in Category 3 and Category 4 Patient Care Spaces

Portion of Receptacle Load to Which Demand Factor Applies (Volt-Amperes) Demand Factor (%) First 10,000 or less 100 Remainder over 10,000 50

## Statement of Problem and Substantiation for Public Input

During the last cycle, there was some doubt as to the adequacy of the research that had been performed. Over the past two years, an enormous amount of additional data has been collected that i can present to the panel (it is currently unpublished, but i would like to consider publishing through NFPA Foundation as an Annex to the study previously performed). This data conclusively establishes that the current demand factors for types 3 and 4 spaces result in oversized systems. The proposed demand factors will result in systems that are sized with large spare capacity; easily sufficient to serve the need.

## Submitter Information Verification

**Submitter Full Name:** Walter Vernon

**Organization:** Mazzetti

**Street Address:**

**City:**

**State:**

**Zip:**

**Submittal Date:** Tue Sep 05 06:00:37 EDT 2023

**Committee:** NEC-P15

### Copyright Assignment

I, Walter Vernon, hereby irrevocably grant and assign to the National Fire Protection Association (NFPA) all and full rights in copyright in this Public Input (including both the Proposed Change and the Statement of Problem and Substantiation). I understand and intend that I acquire no rights, including rights as a joint author, in any publication of the NFPA in which this

Public Input in this or another similar or derivative form is used. I hereby warrant that I am the author of this Public Input and that I have full power and authority to enter into this copyright assignment.

By checking this box I affirm that I am Walter Vernon, and I agree to be legally bound by the above Copyright Assignment and the terms and conditions contained therein. I understand and intend that, by checking this box, I am creating an electronic signature that will, upon my submission of this form, have the same legal force and effect as a handwritten signature